

M U N I
S C I

C5730 Biochemie - seminář

Mgr. Lukáš Faltinek

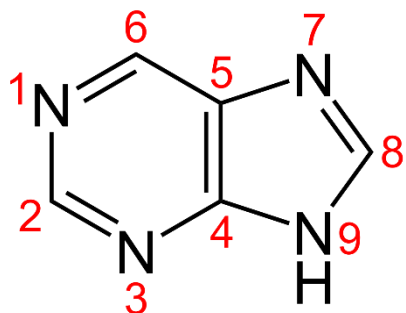
podzim 2023

M U N I
S C I

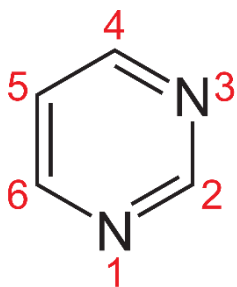
Nukleové kyseliny

Charakteristika

- makromolekulární sloučeniny nesoucí genetickou informaci
- základní stavební jednotkou je nukleotid



purin



pyrimidin

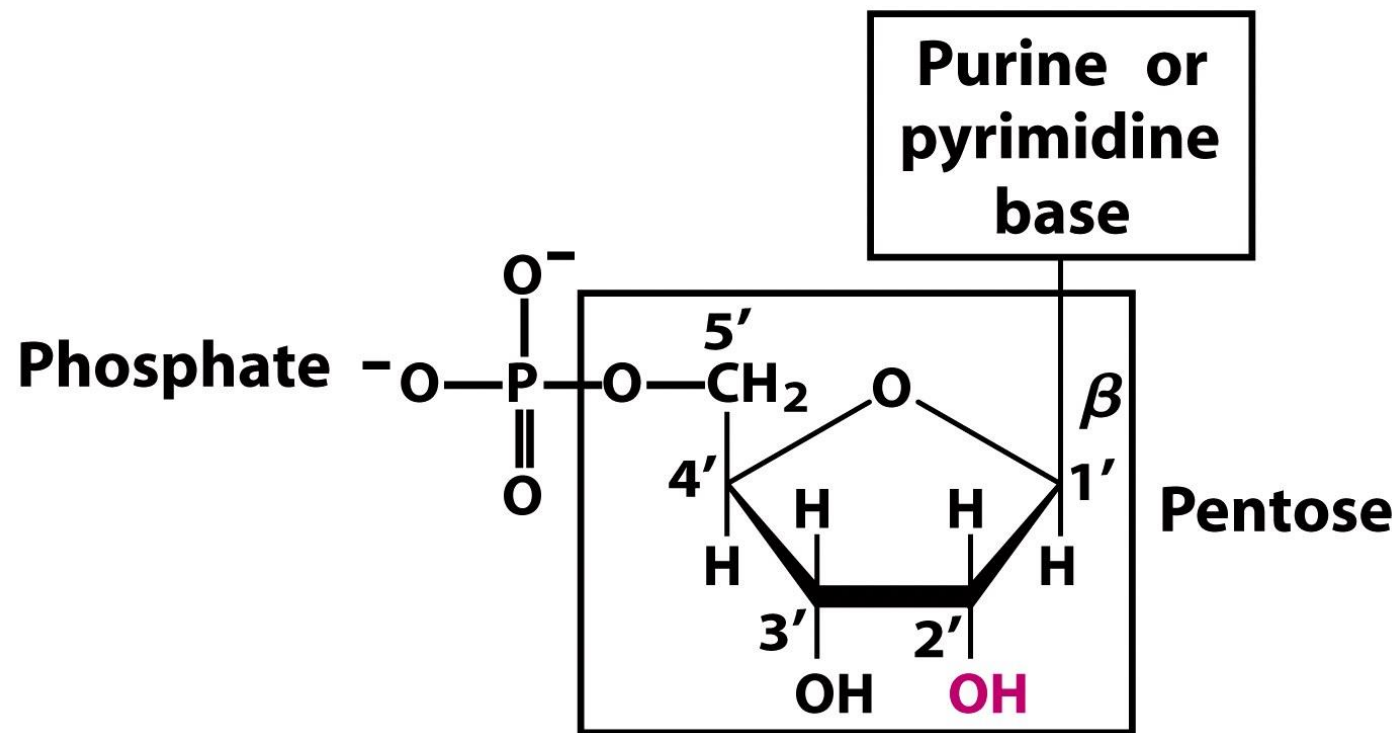
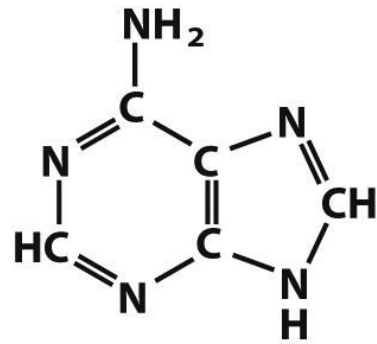
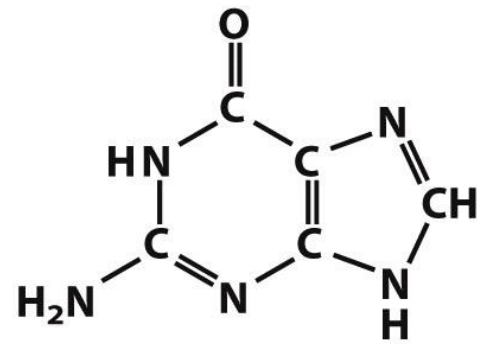


Figure 8-1a
Lehninger Principles of Biochemistry, Fifth Edition
© 2008 W.H. Freeman and Company

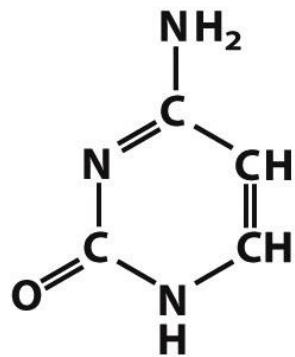


Adenine

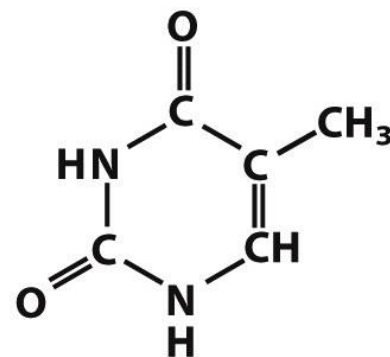


Guanine

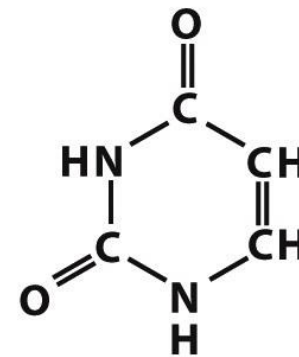
Purines



Cytosine



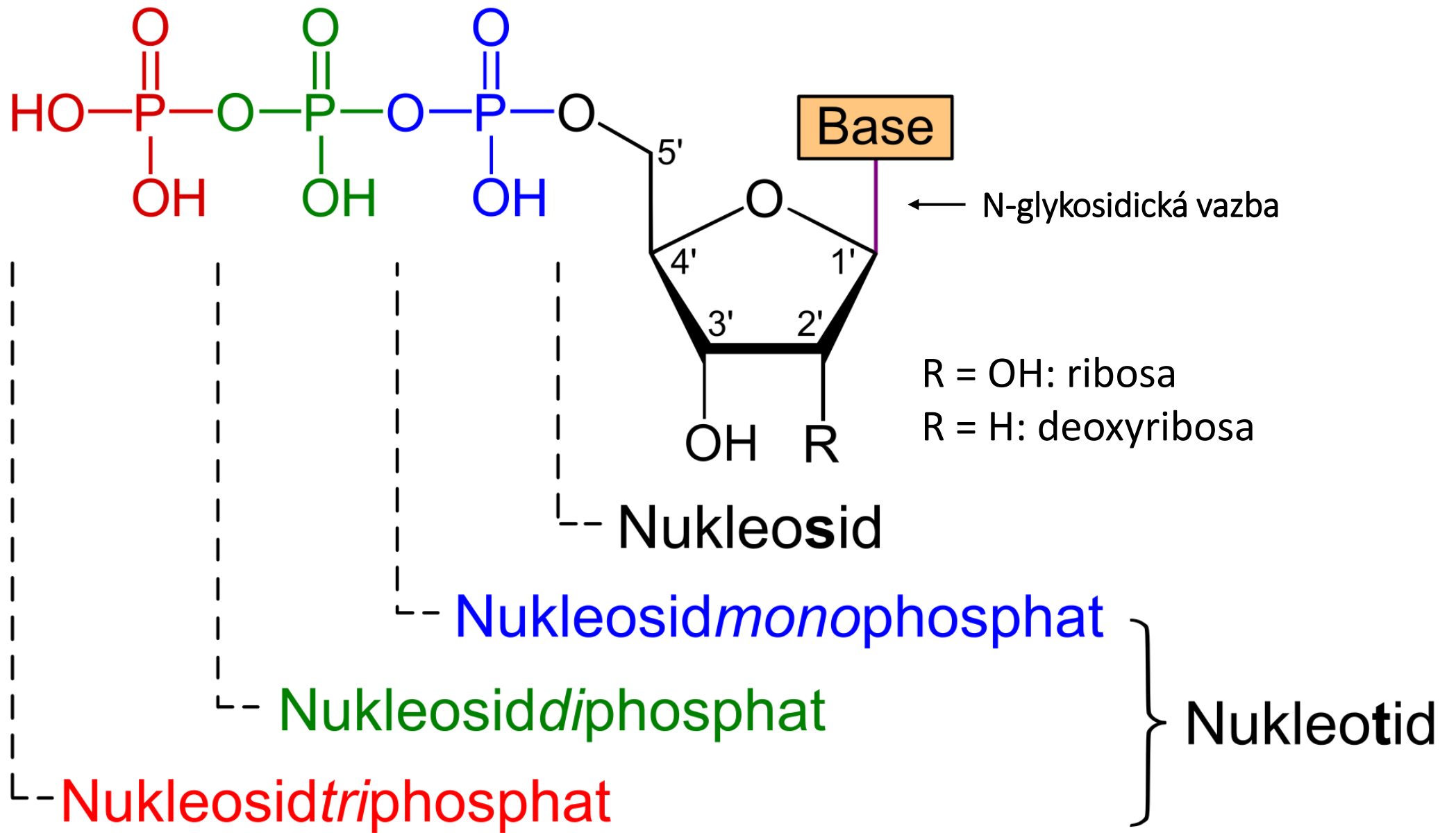
**Thymine
(DNA)**



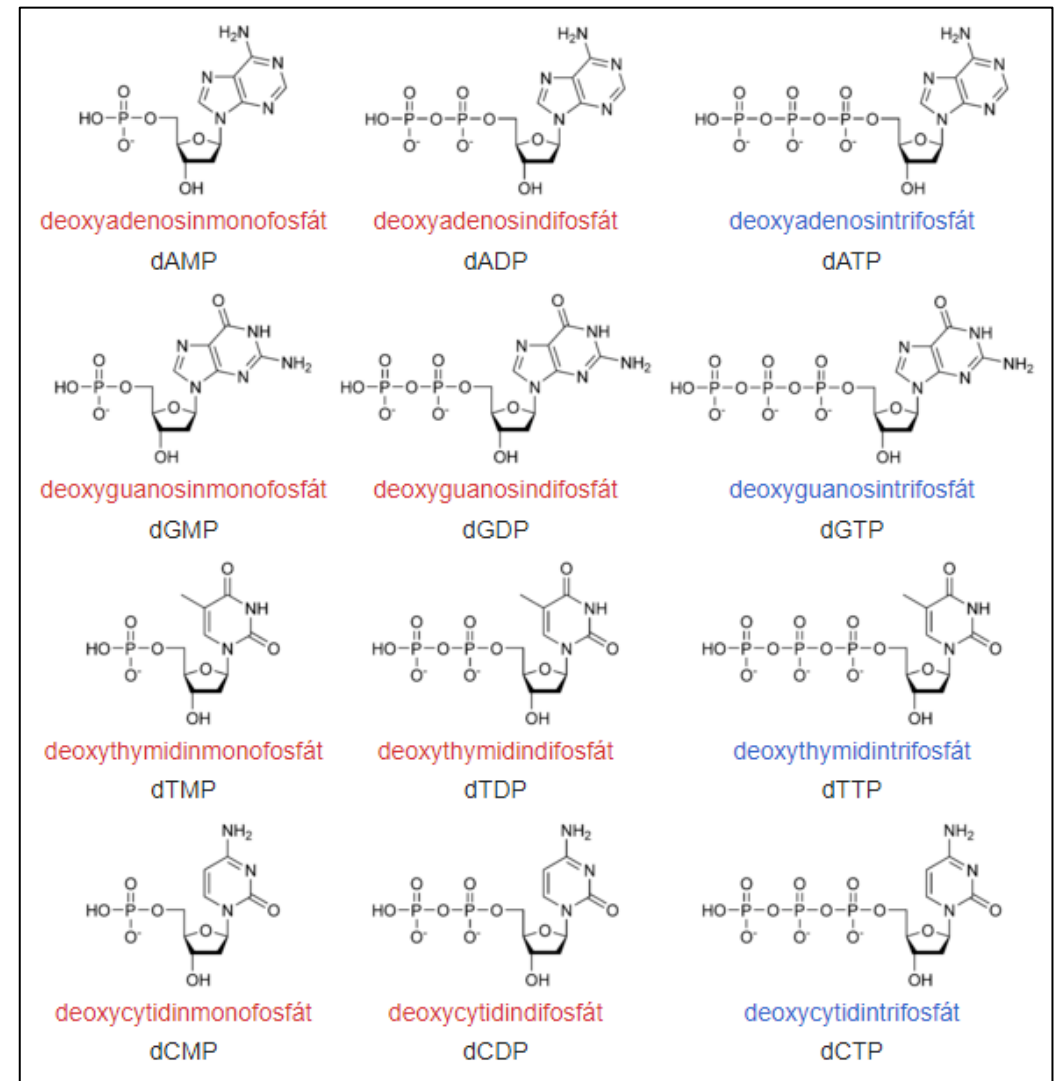
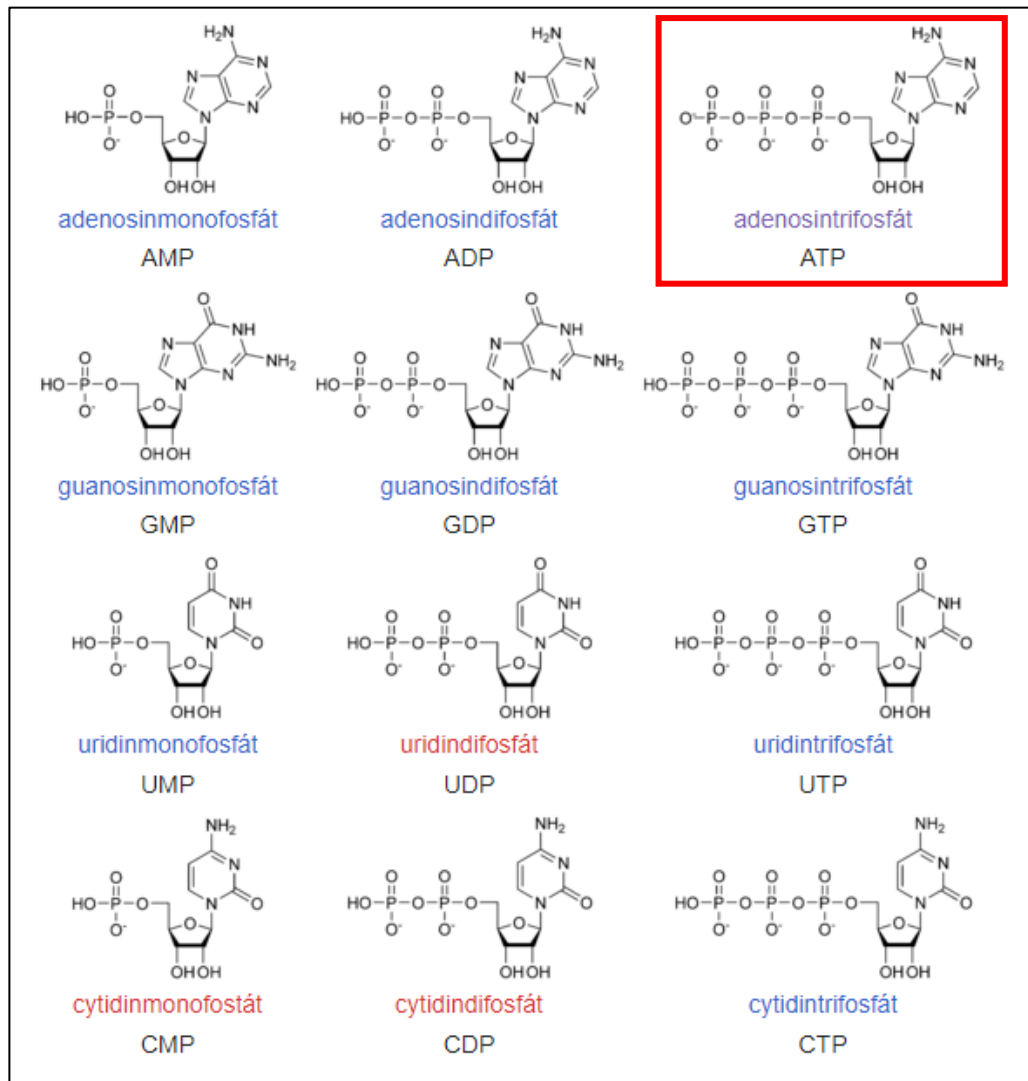
**Uracil
(RNA)**

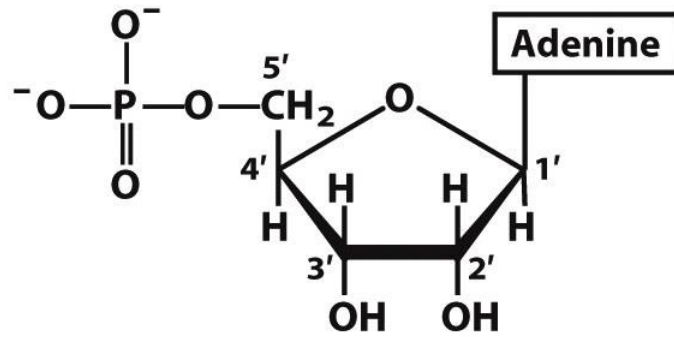
Pyrimidines

Figure 8-2
Lehninger Principles of Biochemistry, Fifth Edition
© 2008 W. H. Freeman and Company

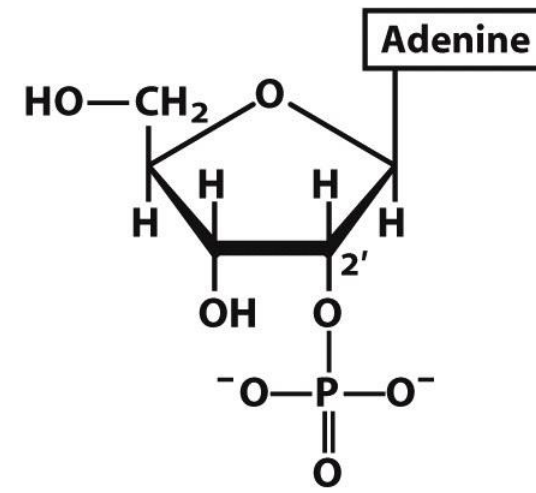


Přehled nukleotidů

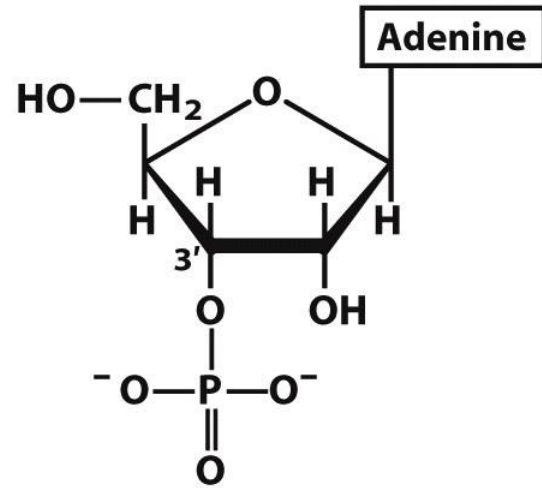




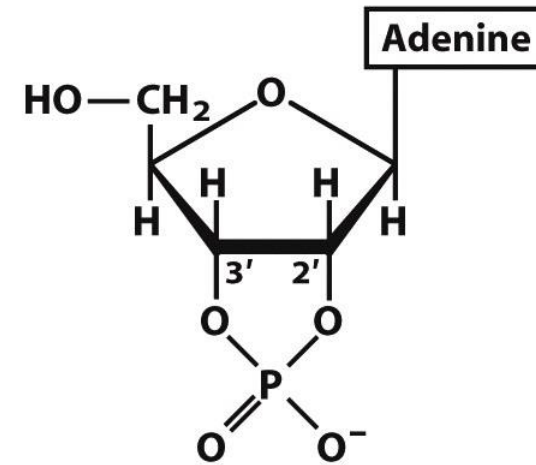
Adenosine 5'-monophosphate



Adenosine 2'-monophosphate



Adenosine 3'-monophosphate



Adenosine 2',3'-cyclic monophosphate

Figure 8-6
Lehninger Principles of Biochemistry, Fifth Edition
 © 2008 W. H. Freeman and Company

Významné molekuly obsahující nukleotid

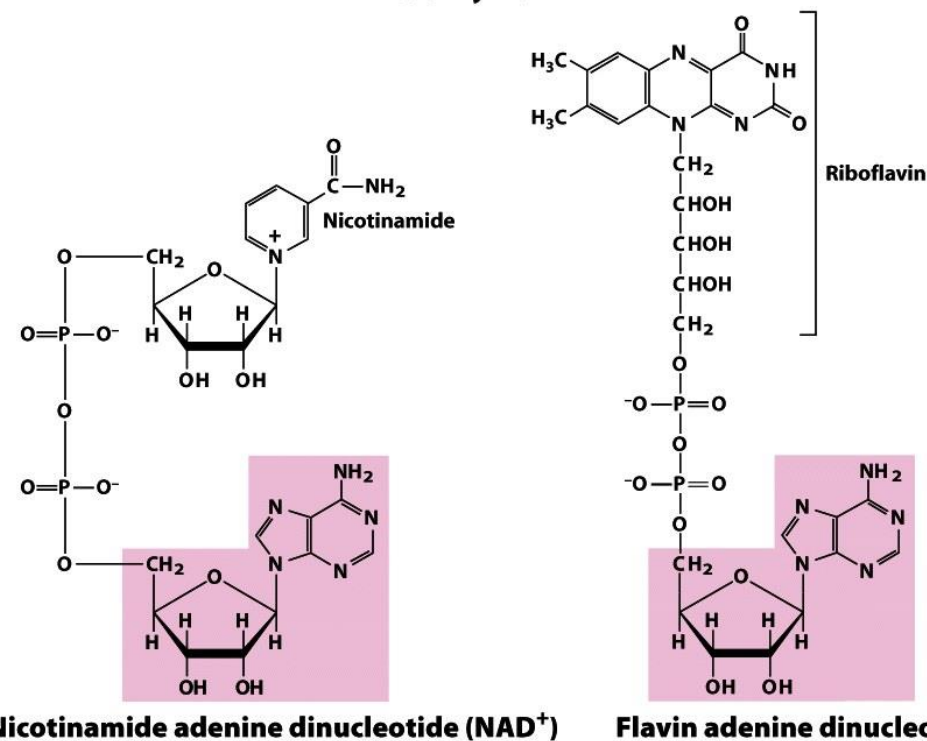
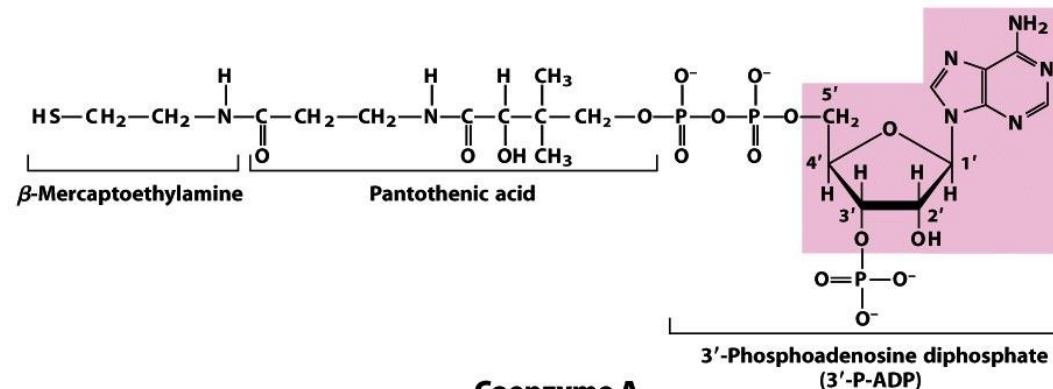
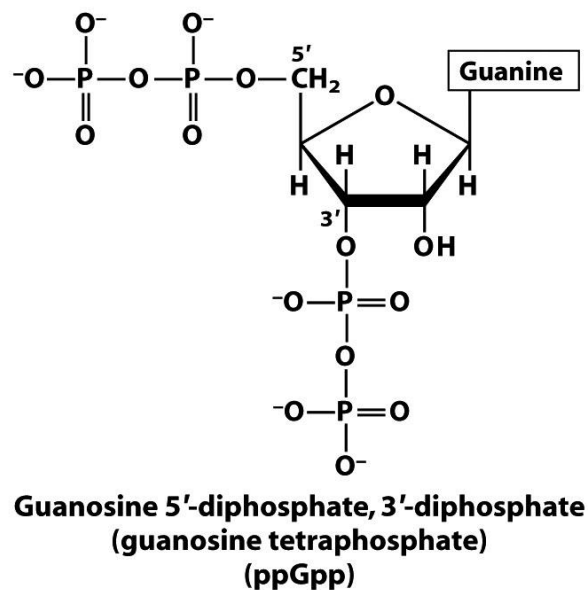
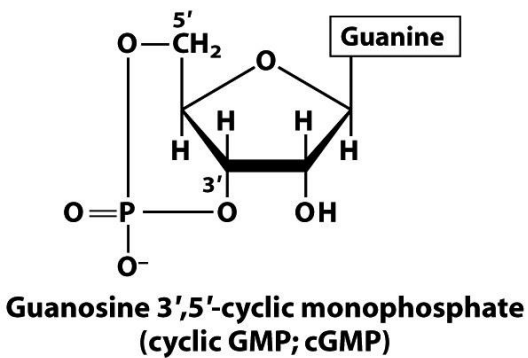
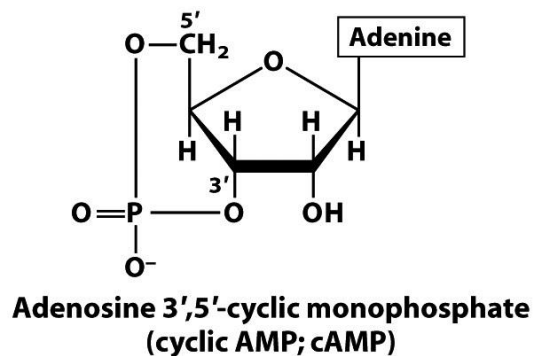


Figure 8-39
Lehninger Principles of Biochemistry, Fifth Edition
© 2008 W. H. Freeman and Company

Figure 8-38
Lehninger Principles of Biochemistry, Fifth Edition
© 2008 W. H. Freeman and Company

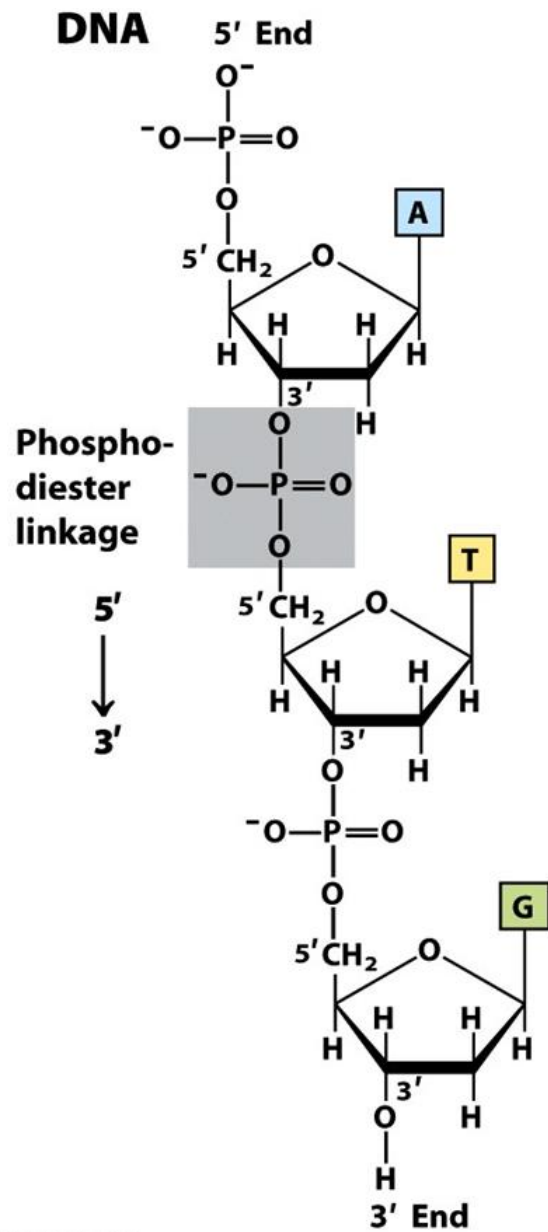


Schéma
nukleotidových
řetězců

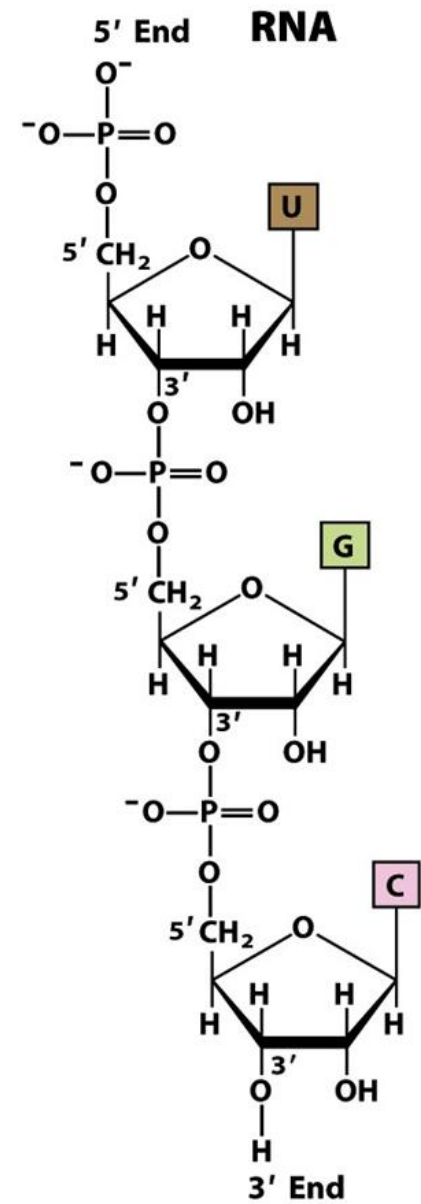
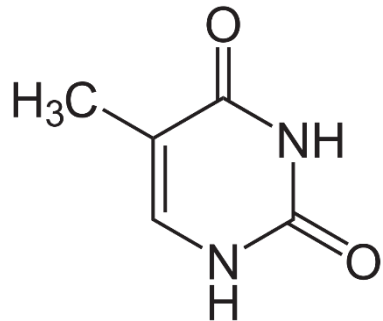


Figure 8-7
Lehninger Principles of Biochemistry, Fifth Edition
© 2008 W. H. Freeman and Company

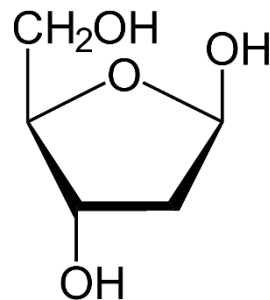
DNA

deoxyribonukleová kyselina

- evolučně mladší
- tvoří dvě vlákna (dvoušroubovici)
- lokalizace v buněčném jádře nebo mitochondriích



thymin

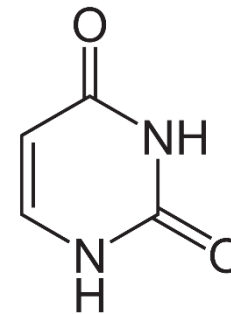


2-deoxyribosa

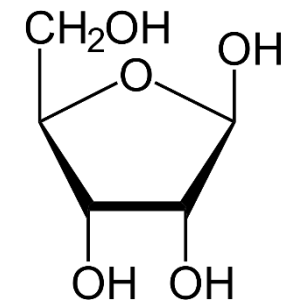
RNA

ribonukleová kyselina

- evolučně starší
- tvoří jedno vlákno
- vznik v jadérku a poté transport do cílových míst



uracil



ribosa

Komplementarita bází

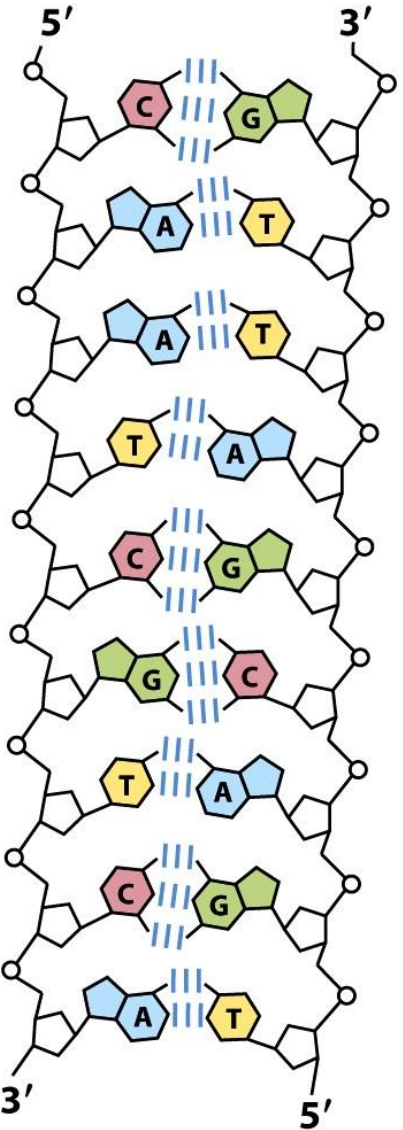
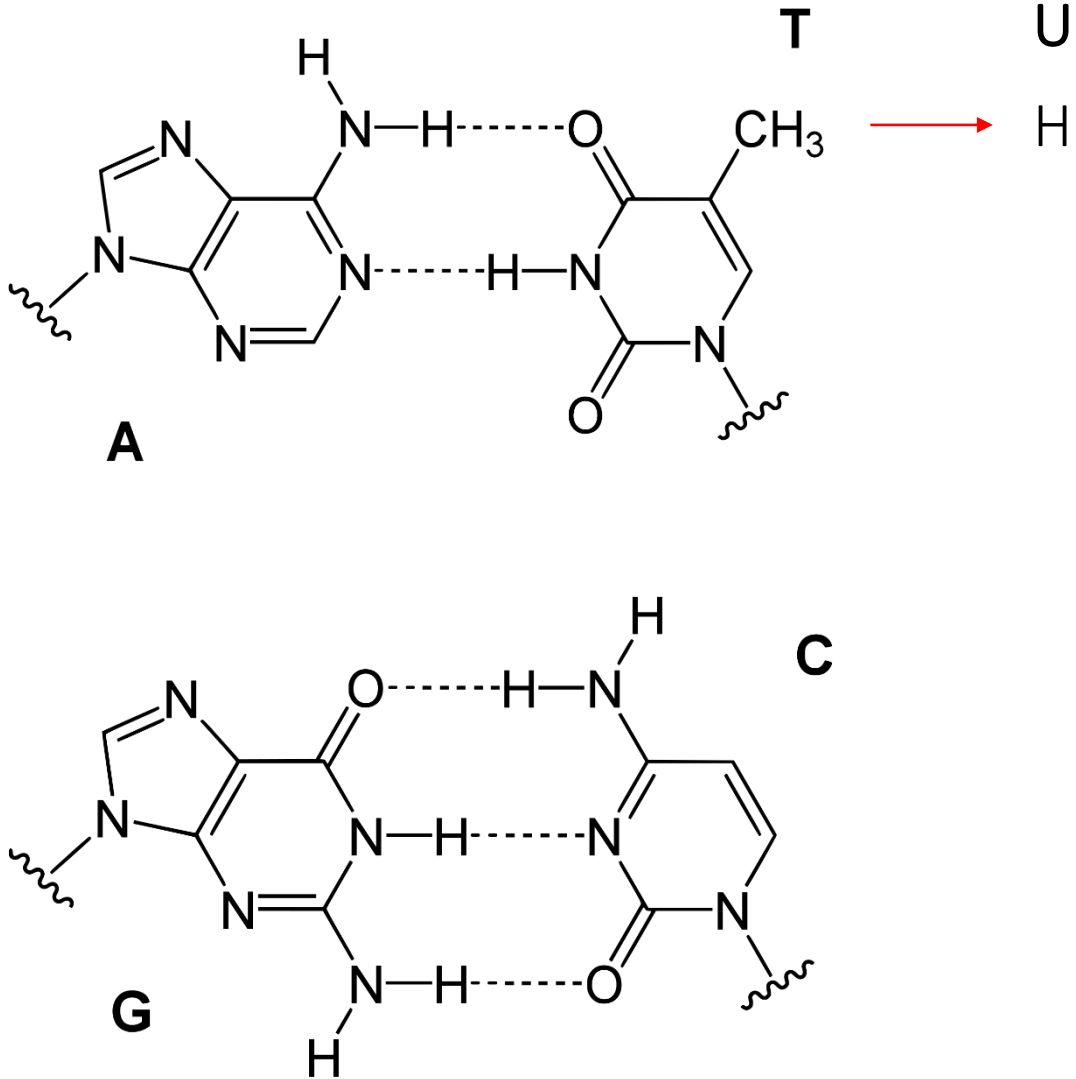
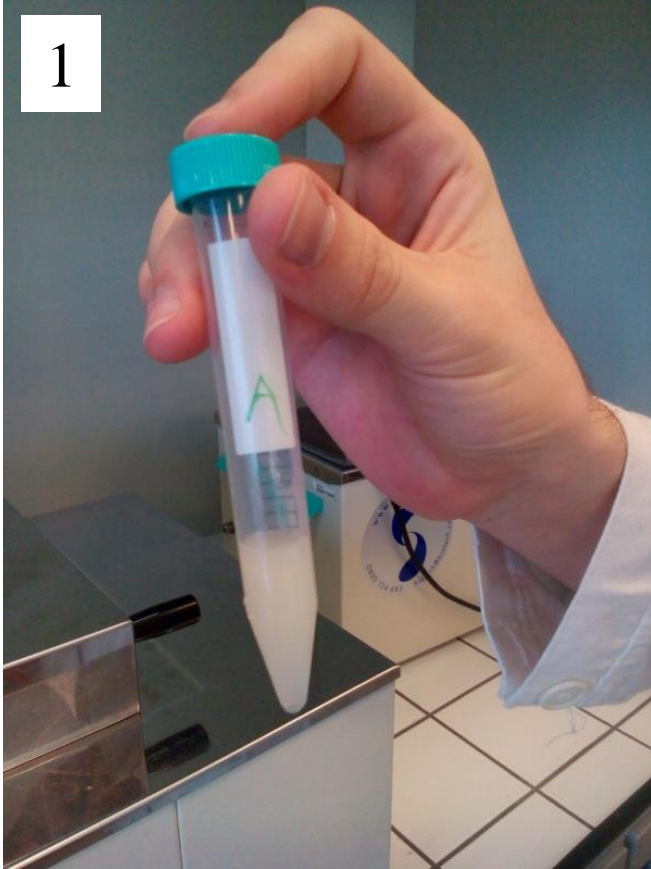


Figure 8-14
Lehninger Principles of Biochemistry, Fifth Edition
© 2008 W. H. Freeman and Company

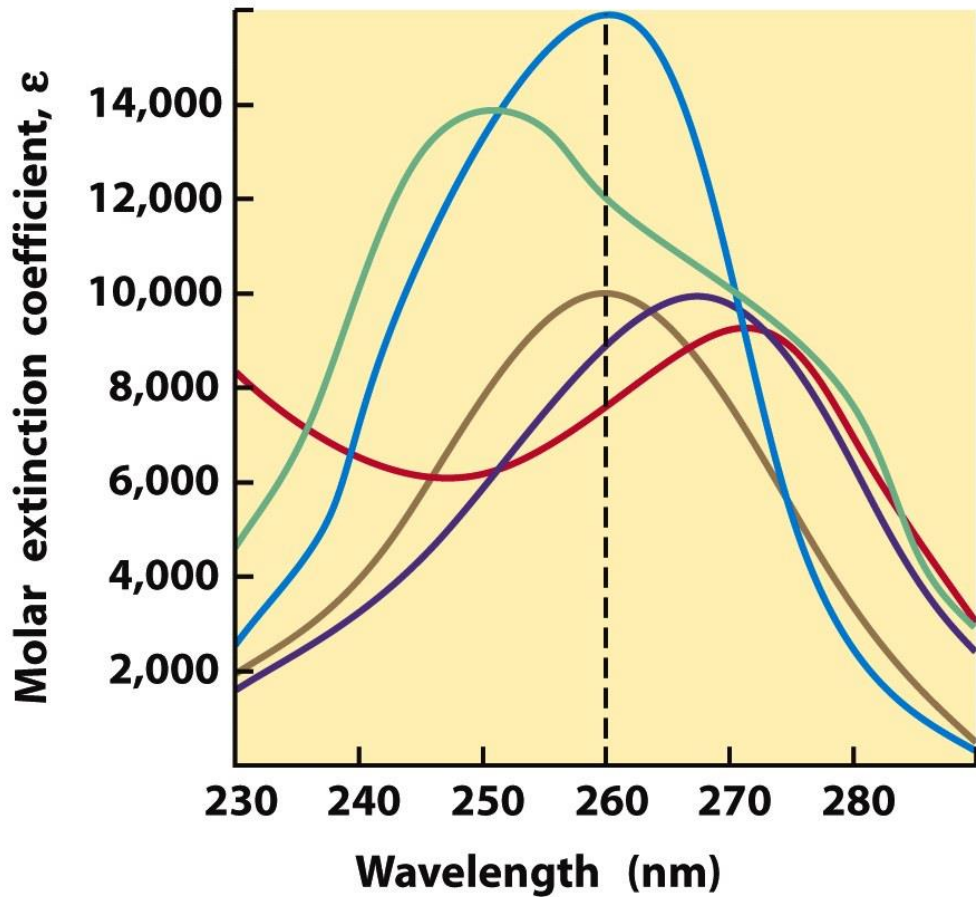


Isolace DNA



- 1) lyze buněk
- 2) deproteinace
- 3) precipitace nukleové kyseliny

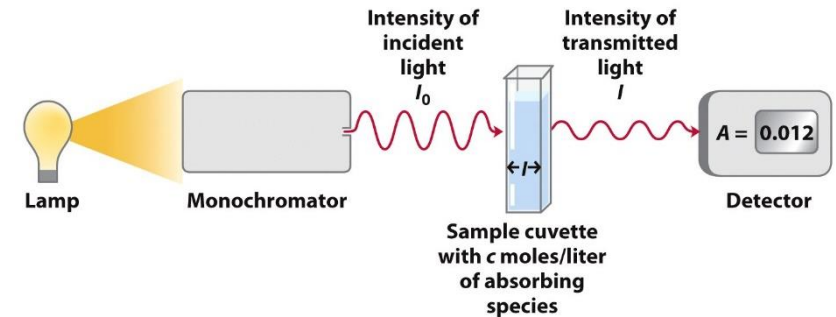
Kvantitativní stanovení NK



Molar extinction coefficient at 260 nm, ϵ_{260} ($M^{-1}cm^{-1}$)	
AMP	15,400
GMP	11,700
UMP	9,900
dTMP	9,200
CMP	7,500

Lambertův-Beerův zákon

$$A = \epsilon \cdot c \cdot l$$



Box 3-1 figure 1
Lehninger Principles of Biochemistry, Fifth Edition
© 2008 W. H. Freeman and Company

Figure 8-10
Lehninger Principles of Biochemistry, Fifth Edition
© 2008 W. H. Freeman and Company

Replikace DNA

- množení molekul DNA: z jedné mateřské molekuly DNA dvě naprosto stejné dceřiné DNA

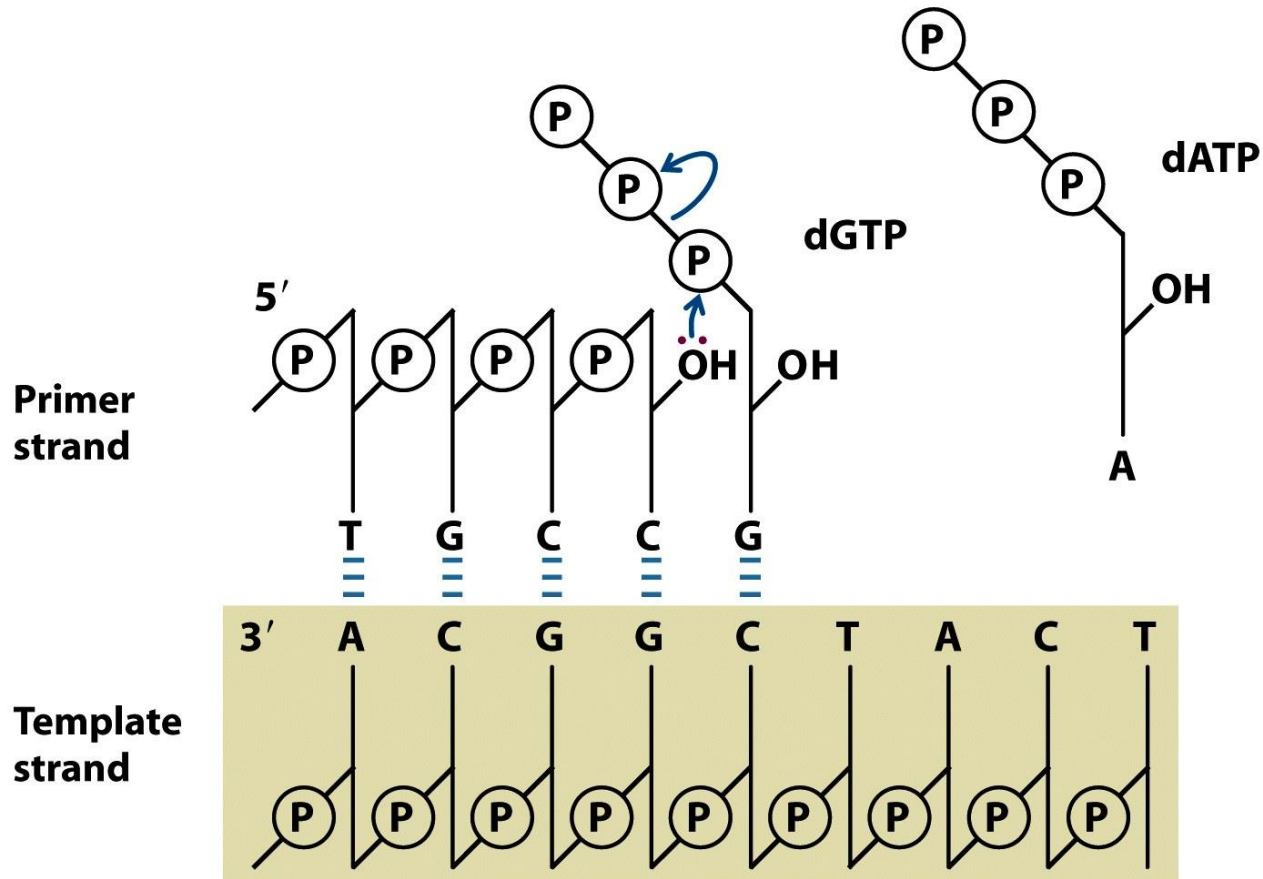


Figure 8-33a
Lehninger Principles of Biochemistry, Fifth Edition
© 2008 W. H. Freeman and Company

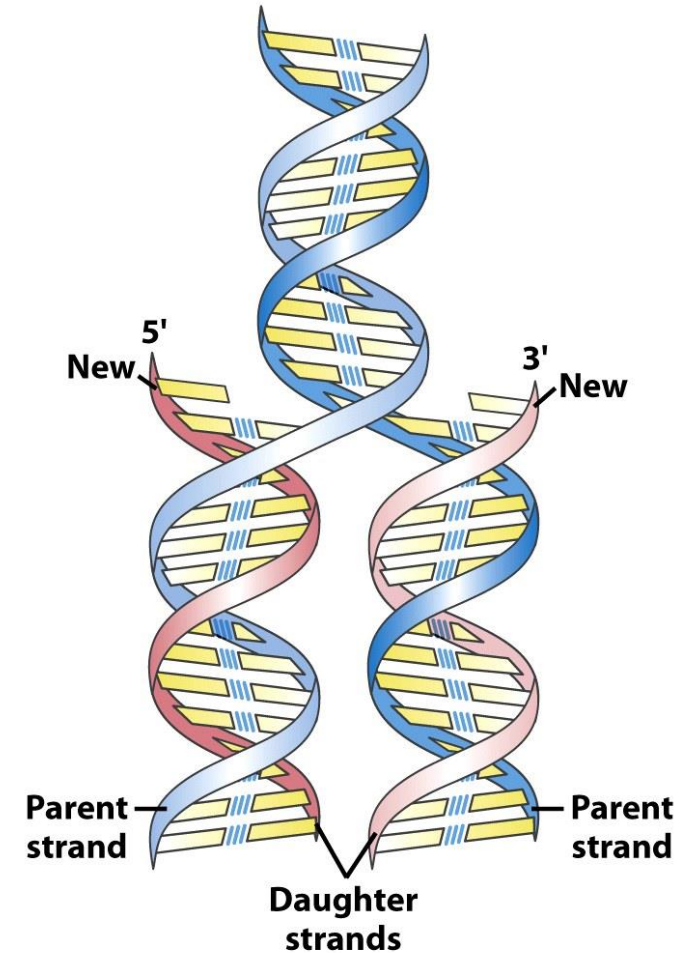


Figure 8-15
Lehninger Principles of Biochemistry, Fifth Edition
© 2008 W. H. Freeman and Company

Sangerovo sekvencování

- ve vzorku směs dNTP a ddNTP (dideoxynukleosidtrifosfáty)
- ddNTP jsou značené fluorescenční barvou
- vznik různých segmentů DNA
- elektroforetická separace
- analýza získaných dat

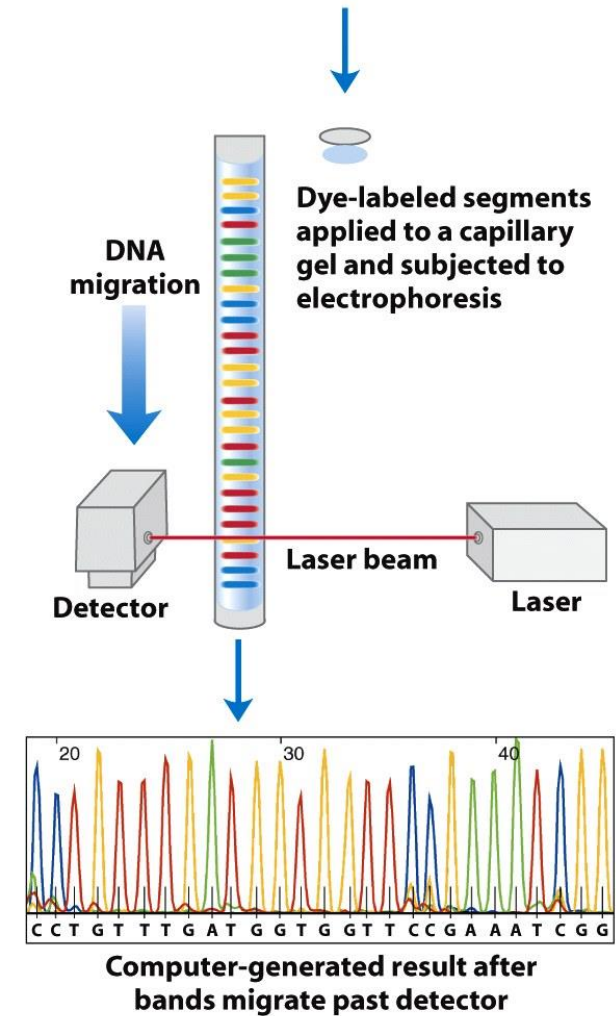
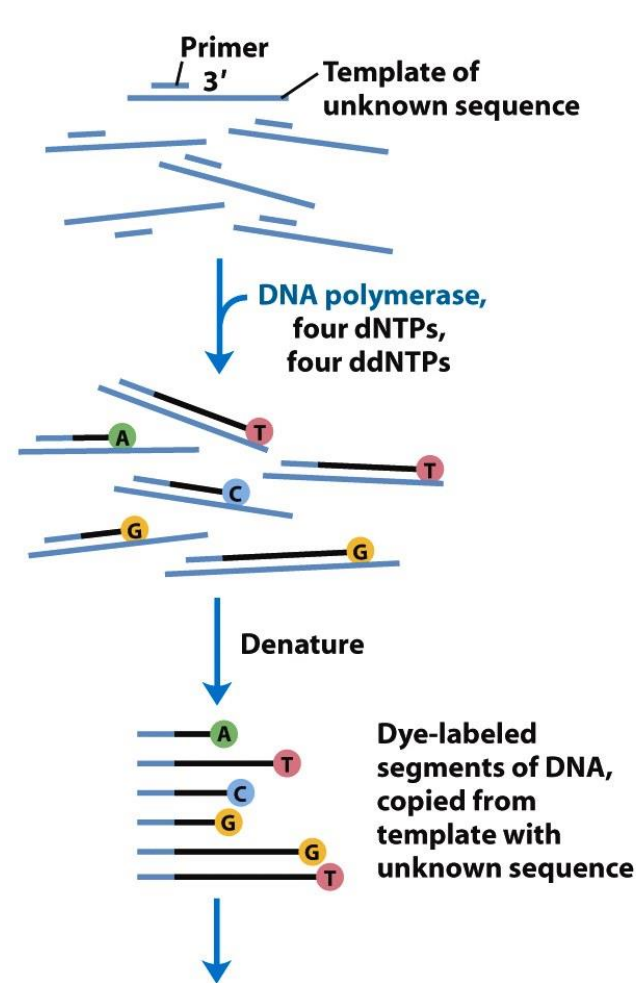
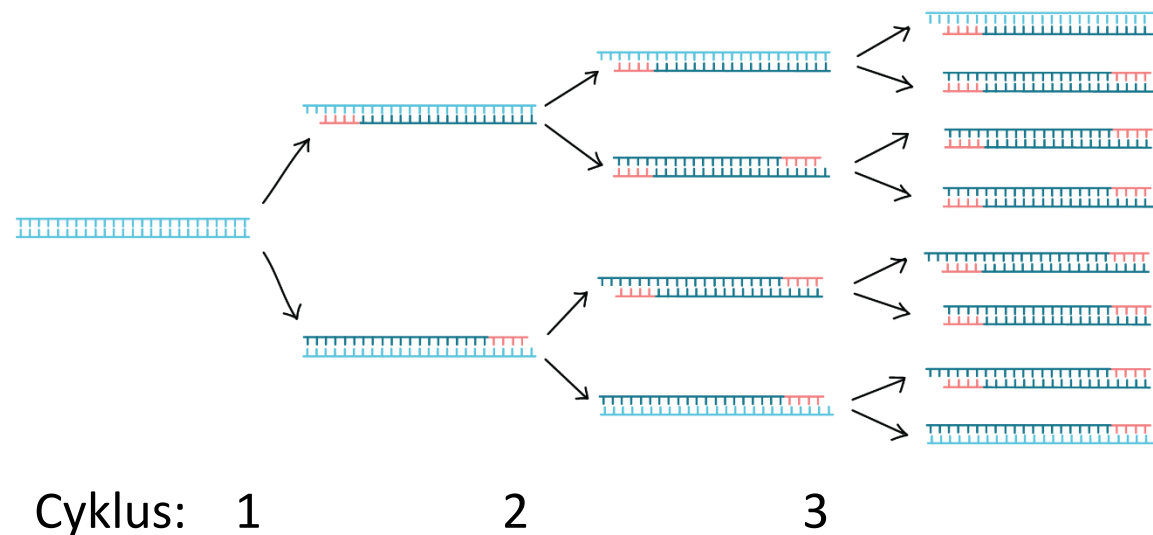


Figure 8-34
Lehninger Principles of Biochemistry, Fifth Edition
© 2008 W. H. Freeman and Company

Polymerázová řetězová reakce

➤ řízená opakovaná denaturace a replikace nukleotidového vlákna

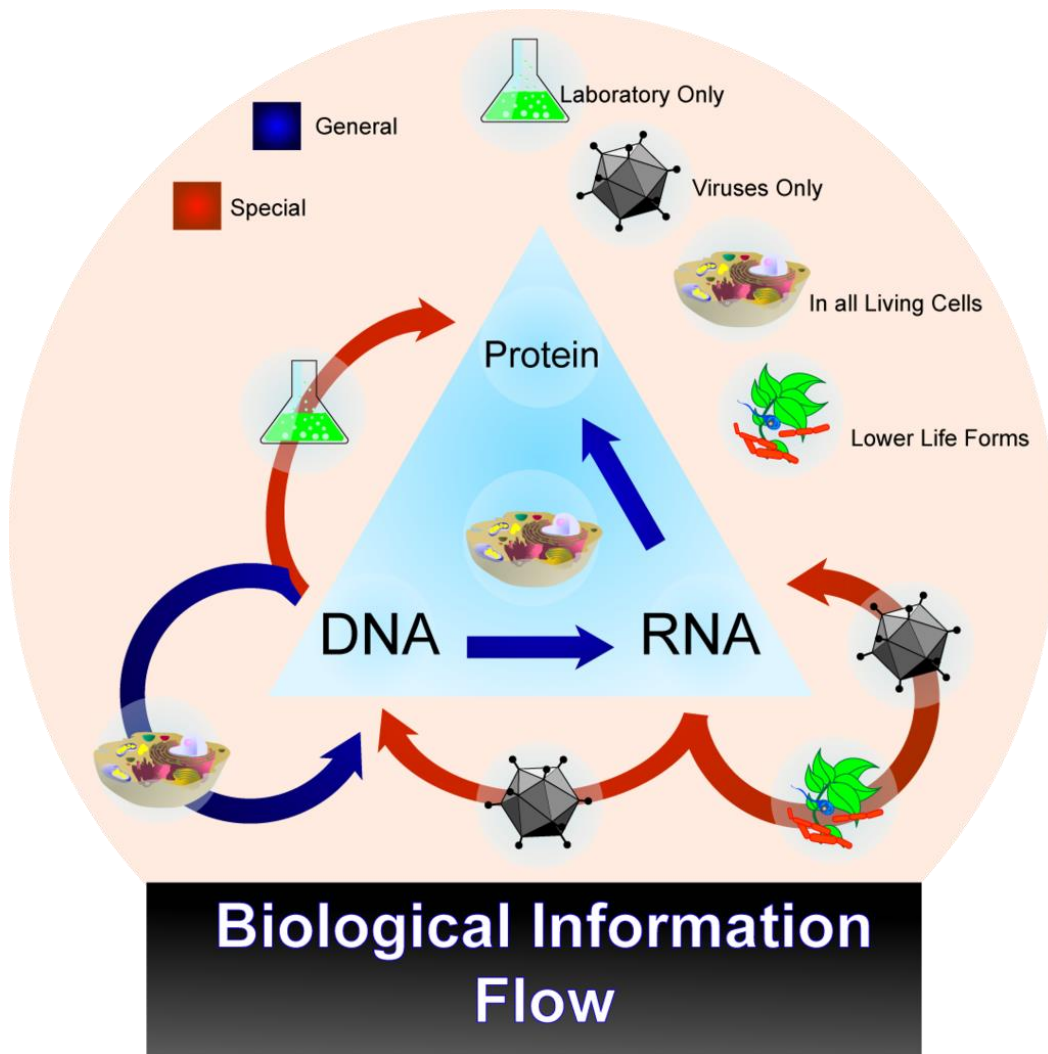
- Denaturace
- Hybridizace (annealing)
- Elongace



Tabulka V: Průběh PCR reakce.

Fáze PCR reakce	Počet cyklů	Teplota	Doba cyklu
Počáteční denaturace	1	95 °C	2 min
Denaturace	30	95 °C	20 s
Nasednutí primerů		50 °C	3 min
Syntéza DNA		72 °C	3 min
Závěrečná elongace	1	72 °C	10 min

Tok biologických informací



replikace:	DNA	DNA
transkripce:	DNA	mRNA
translace:	mRNA	protein

reverzní transkripce:	RNA	DNA
RNA přepis:	RNA	RNA

Genetický kód

- primární struktura DNA v sobě nese informaci o primární struktuře proteinů
- **Princip:** trojice nukleotidů (triplet, **kodon**) kóduje určitou aminokyselinu

Kolik existuje proteinogenních aminokyselin?

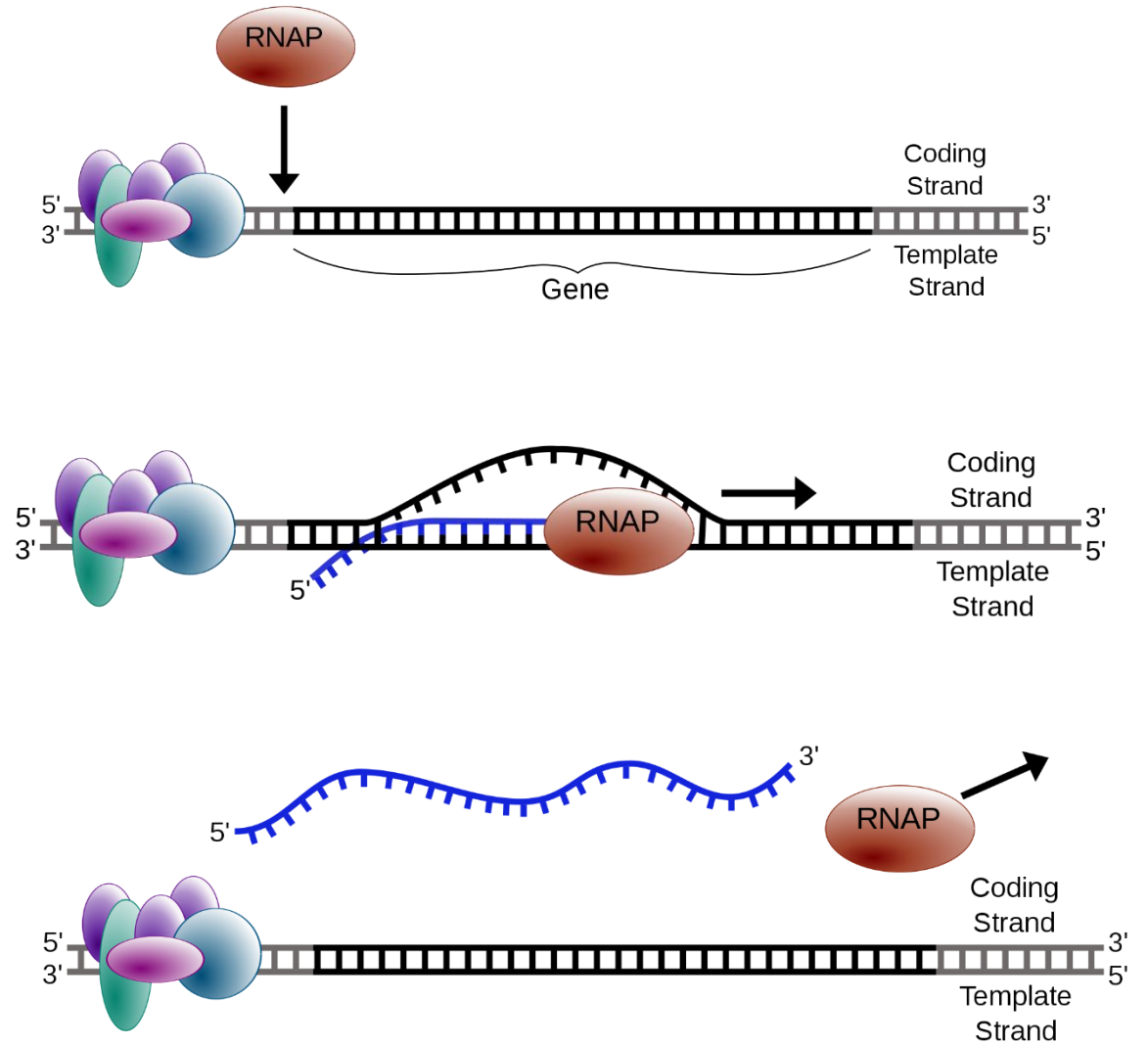
Kolik existuje různých kodonů?

		Second letter				
		U	C	A	G	
First letter	U	UUU } Phe UUC } UUA } Leu UUG }	UCU } UCC } Ser UCA } UCG }	UAU } Tyr UAC } UAA Stop UAG Stop	UGU } Cys UGC } UGA Stop UGG Trp	U C A G
	C	CUU } CUC } Leu CUA } CUG }	CCU } CCC } Pro CCA } CCG }	CAU } His CAC } CAA } Gln CAG }	CGU } CGC } Arg CGA } CGG }	U C A G
	A	AUU } AUC } Ile AUA } AUG Met	ACU } ACC } Thr ACA } ACG }	AAU } Asn AAC } AAA } Lys AAG }	AGU } Ser AGC } AGA } Arg AGG }	U C A G
	G	GUU } GUC } Val GUA } GUG }	GCU } GCC } Ala GCA } GCG }	GAU } Asp GAC } GAA } Glu GAG }	GGU } GGC } Gly GGA } GGG }	U C A G

Proteosyntéza - transkripce

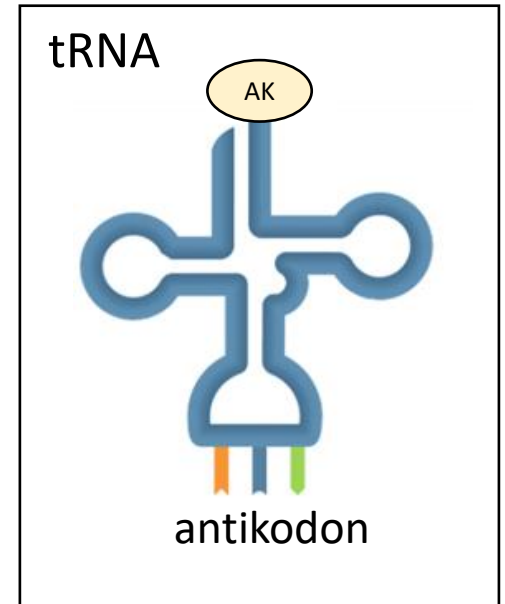
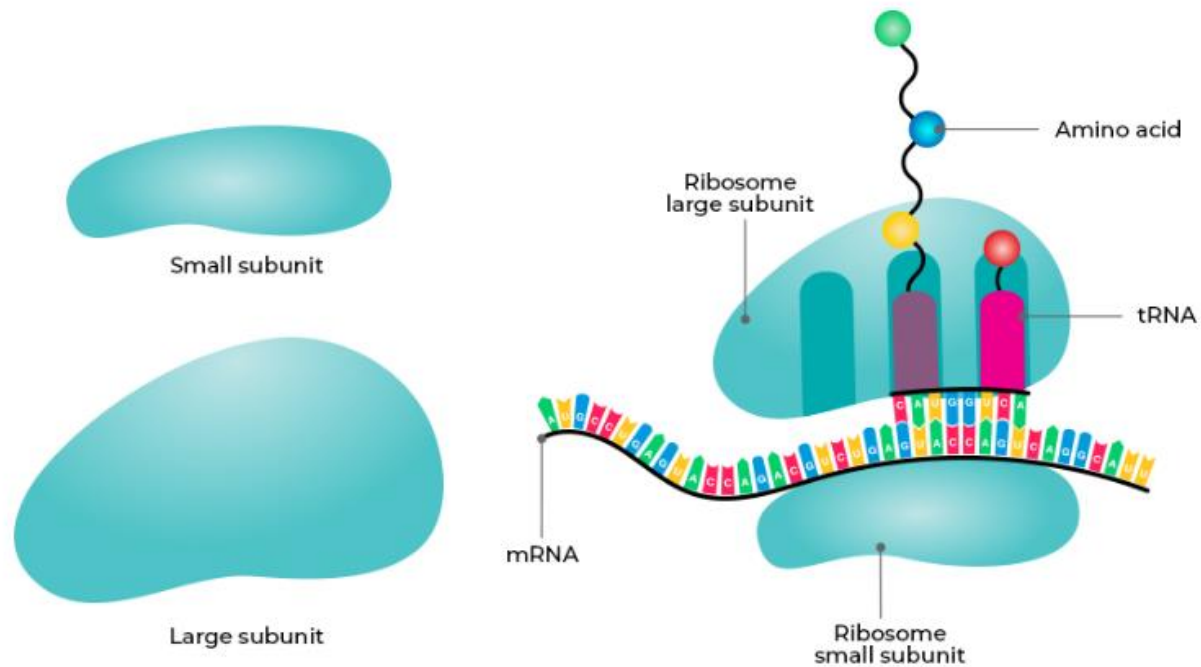
- přepis genetické informace z DNA do vlákna RNA
- vznik mRNA = messengerová RNA
- posttranskripční úpravy
 - připojení polyadenylové sekvence na 3' konec
 - sestřih nekódujících oblastí (exony X introny)

ve směru 5' → 3'



Proteosyntéza - translace

- **překlad** nukleotidové sekvence mRNA do sekvence aminokyselin
- probíhá na **ribozomech** (rRNA a protein)
- **tRNA** (transferová RNA) jako nositel jednotlivých aminokyselin
- posttranslační úpravy



UŽITEČNÉ ODKAZY

replikace DNA

<https://www.youtube.com/watch?v=TNKWgcFPHqw>

polymerázová řetězová reakce

<https://www.youtube.com/watch?v=2KoLnlwoZKU>

translace

<https://www.youtube.com/watch?v=5bLEDd-PSTQ>

od DNA k proteinu

<https://www.youtube.com/watch?v=gG7uCskUOrA>

Sangerova
sekvenace

<https://www.youtube.com/watch?v=dVRB4CaLizc>