

# Trace element analysis of geological materials by ICP-MS I

DSP analytical geochemistry

C9067

Markéta Holá, MU Brno



EVROPSKÁ UNIE  
Evropské strukturální a investiční fondy  
Operační program Výzkum, vývoj a vzdělávání



MINISTERSTVO ŠKOLSTVÍ,  
MLÁDEŽE A TĚLOVÝCHOVY

Tento učební materiál vznikl v rámci projektu Rozvoj doktorského studia chemie  
č. CZ.02.2.69/0.0/0.0/16\_018/0002593

# Outline

1. Mass spectrometry. General introduction and history.
2. Ion sources for mass spectrometry. Inductively coupled plasma.
3. Interface. Ion optics. Mass discrimination. Vacuum system.
4. Spectral interferences. Resolution, ion resolution calculations.
5. Mass analyzers. Elimination of spectral interferences.
6. Non-spectral interference.
7. Detectors, expression of results.
8. Introduction of samples into plasma.
9. Laser ablation for ICP-MS.
10. Excursion in the laboratory.

# Mass Spectrometry

basics

“The basic principle of mass spectrometry (MS) is to generate ions from either inorganic or organic compounds by any suitable method, to separate these ions by their mass-to-charge ratio ( $m/z$ ) and to detect them qualitatively and quantitatively by their respective  $m/z$  and abundance...”

(Kienitz, 1968)

# Mass Spectrometry

## basics

It follows directly from this definition that atoms or molecules need to carry an electric charge, i.e., they need to be transformed into ions, for MS to work.

### WHY IONS?

**The electric charge acts like a handle that allows to grab these atoms or molecules. In contrast to neutrals, ions can be accelerated and decelerated, can be shot into defined orbits or other flight paths, and can finally be collected and detected.** The “race tracks” of these ions can be determined by application of electric and/or magnetic fields. While the Coulombic force is exerted on ions in electric fields, the Lorentz force influences ions moving with a component orthogonal to the magnetic field.

# Mass Spectrometry

basics

## Moving of particles in an electric field

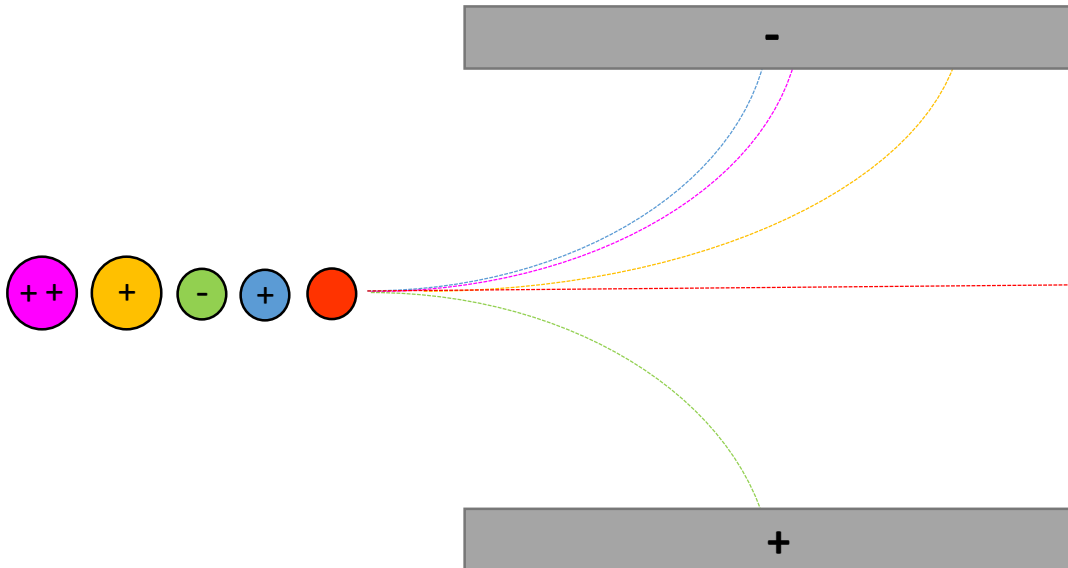

The electric (Coulomb) force  $F_{el}$  exerted by the field on the positive charge is:

$$F_{el} = q E = \frac{m v^2}{r}$$

$q$  charge magnitude

$E$  electric field ( $N \cdot C^{-1}$ ;  $V \cdot m^{-1}$ )

$m$  mass (kg)

$v$  velocity ( $m \cdot s^{-1}$ )

$r$  radius of the ion path

$$r = \frac{m v^2}{q E}$$

# Mass Spectrometry

basics

## Moving of particles in a magnetic field

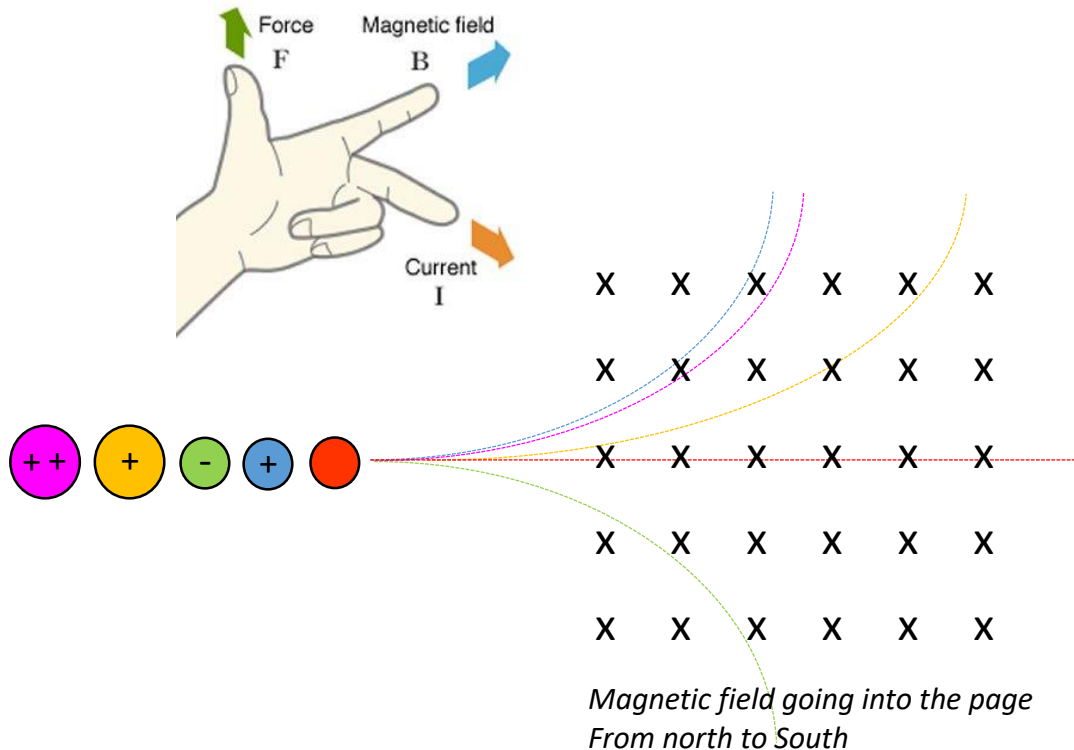

The magnetic (Lorentz) force  $F_{mag}$  exerted by the field on the positive charge is:

$$F_{mag} = q v B = \frac{m v^2}{r}$$

$q$  charge magnitude

$B$  magnetic induction ( $T; \text{kg}\cdot\text{s}^{-2}\cdot\text{A}^{-1}$ )

$m$  mass (kg)

$v$  velocity ( $\text{m}\cdot\text{s}^{-1}$ )

$r$  radius of the ion path

$$r = \frac{m v}{q B}$$

# Mass Spectrometry

basics

$$r = \frac{m v^2}{q E} \qquad r = \frac{m v}{q B}$$

Ions can be separated due to the mass-to-charge ratio  $\frac{m}{z}$  (dimensionless quantity)

$q$  ("quantum") is used as symbol for the electric charge, while  $z$  is used as unit for the charge number, e.g. 1, 2, -1, -2 etc.

$$\frac{m}{z} = 50 \dots\dots\dots \frac{100}{2} \text{ or } \frac{50}{1} \quad \dots\text{the same separation for different analytes.}$$

# Mass Spectrometry

basics

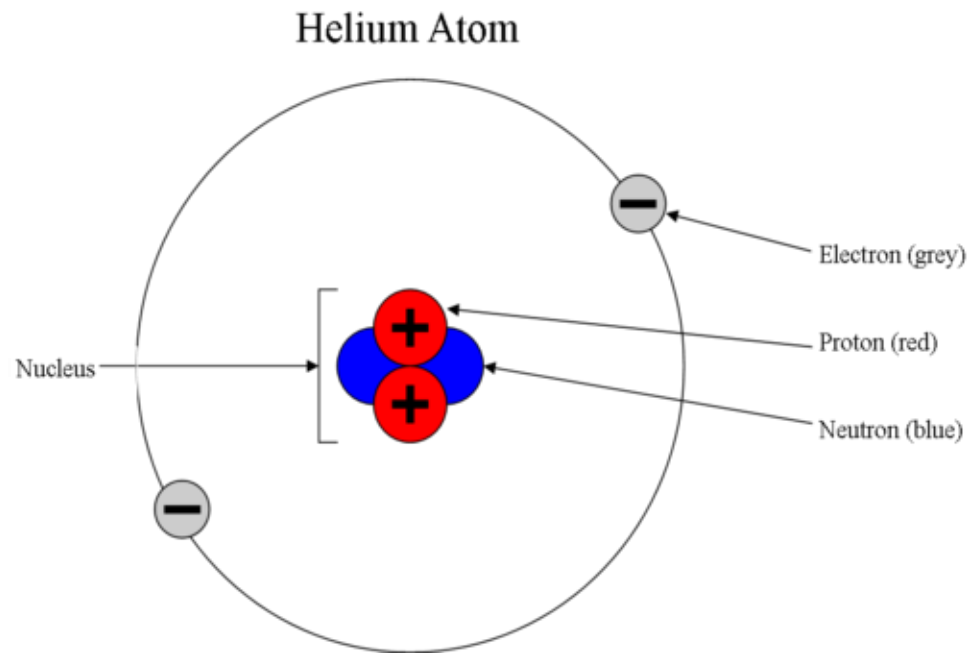

Name	Charge	Symbol	Mass (kg)	Mass (u)	Location
proton	1+	${}^1_1\text{P}^+$	$1.673 \times 10^{-27}$	1	Inside nucleus
neutron	0	${}^1_0\text{n}$	$1.675 \times 10^{-27}$	1	Inside nucleus
electron	1-	$e^-$	$9.109 \times 10^{-31}$	0	Outside nucleus

Mass number=(# protons)+(# neutrons)

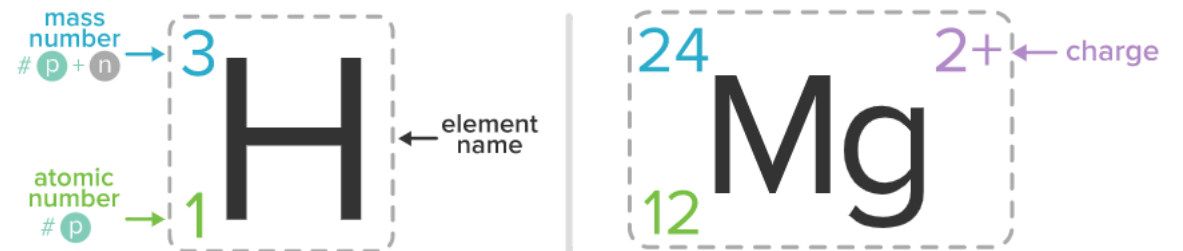



# Mass number vs. Atomic mass unit

**Mass number** - also called atomic mass number or nucleon number, is the total number of protons and neutrons (together known as nucleons) in an atomic nucleus.

**AMU atomic mass unit** - It is a unit of mass used to express atomic or molecule masses. When the mass is expressed in AMU, it roughly reflects the sum of the number of protons and neutrons in the atomic nucleus (electrons have so much less mass that they are assumed to have a negligible effect).

$$m_u = m(^{12}\text{C})/12$$

$$1 \text{ AMU} = 1 m_u = 1 \text{ Da} = 1.66053904020 \times 10^{-27} \text{ kg}$$

Mass number

  $^{56}\text{Fe}$  amu 55.9349363

# Mass number vs. Atomic mass unit

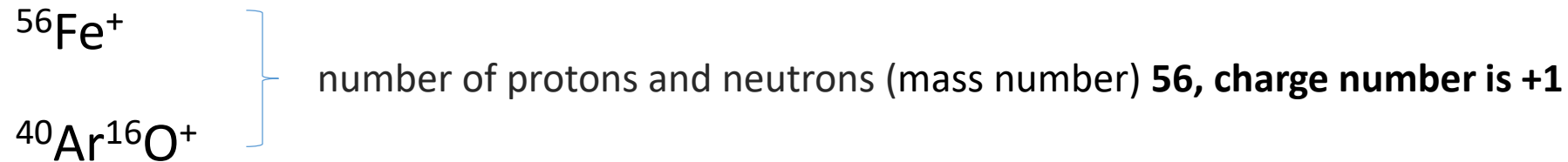

$$\frac{m}{z} = 56$$

AMU:  $^{40}\text{Ar}^{16}\text{O}$  **55.957** vs.  $^{56}\text{Fe}$  **55.935**

It is possible to distinguish!

AMU:  $^{40}\text{Ar}$  **39.96238312** vs  $^{40}\text{Ca}$  **39.9625909**

No mass spectrometer has sufficient resolving power!



# Mass Spectrometry

in general

- Analytical method
- works with the resolution according to the **m/z** ratio, where m is the mass and z is the charge of the fragment-ion (molecule, part of the molecule, atom)
- determination of molecular weight, elucidation of **chemical structure** of peptides or other organic compounds, determination of **elemental composition** of sample
- the principle of mass spectrometry is based on ionization of molecules or atoms, their subsequent separation by m/z and detection

# Mass Spectrometry

of organic compounds

- structural analysis
- identification of substances

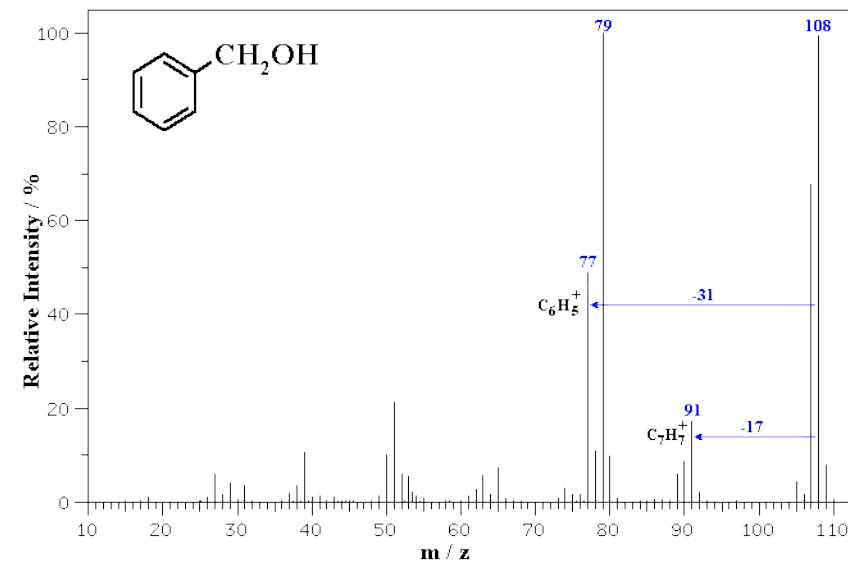
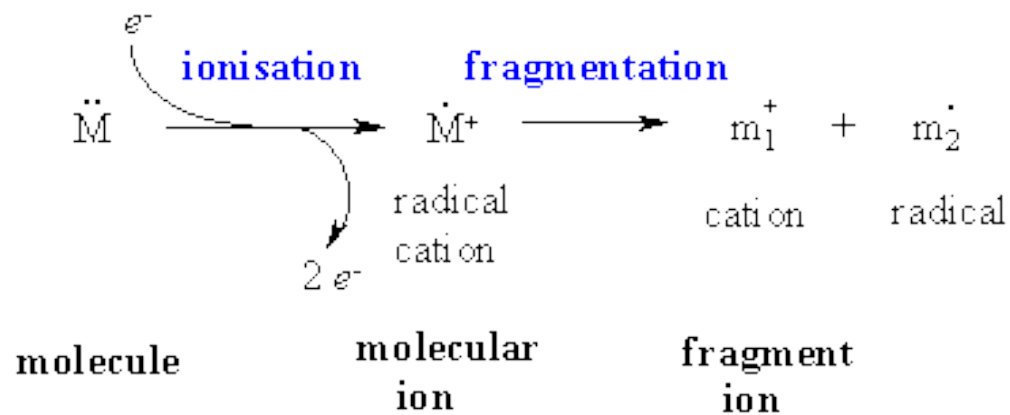
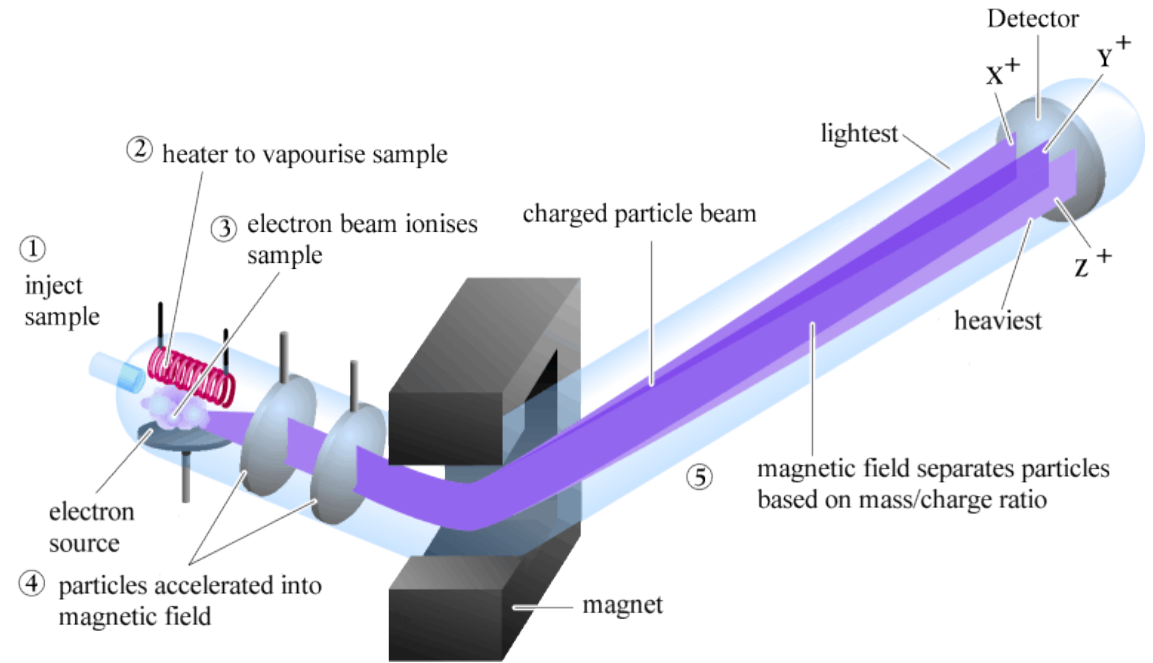

# Mass Spectrometry

of organic compounds

Different compounds can be uniquely identified by their mass

**Butorphanol**

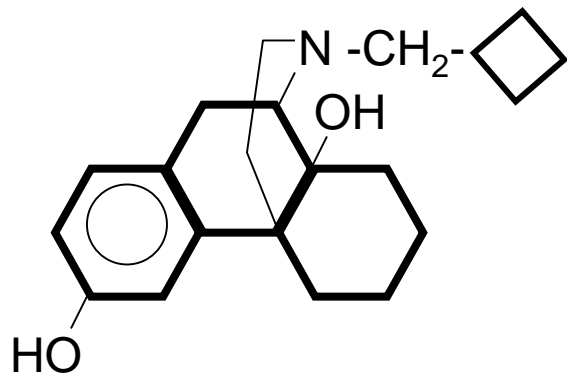

**MW = 327.1**

**L-dopa**

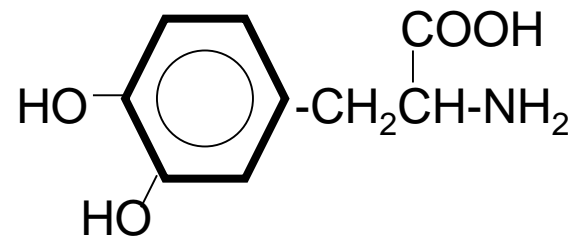

**MW = 197.2**

**Ethanol**



**MW = 46.1**



# Mass Spectrometry

inorganic

- elemental trace analysis
- isotopic ratio – radiometric dating
- elemental imaging

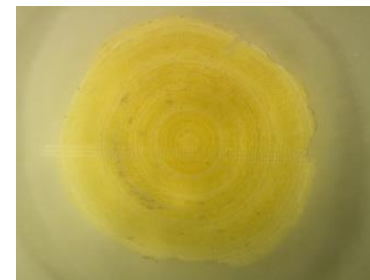
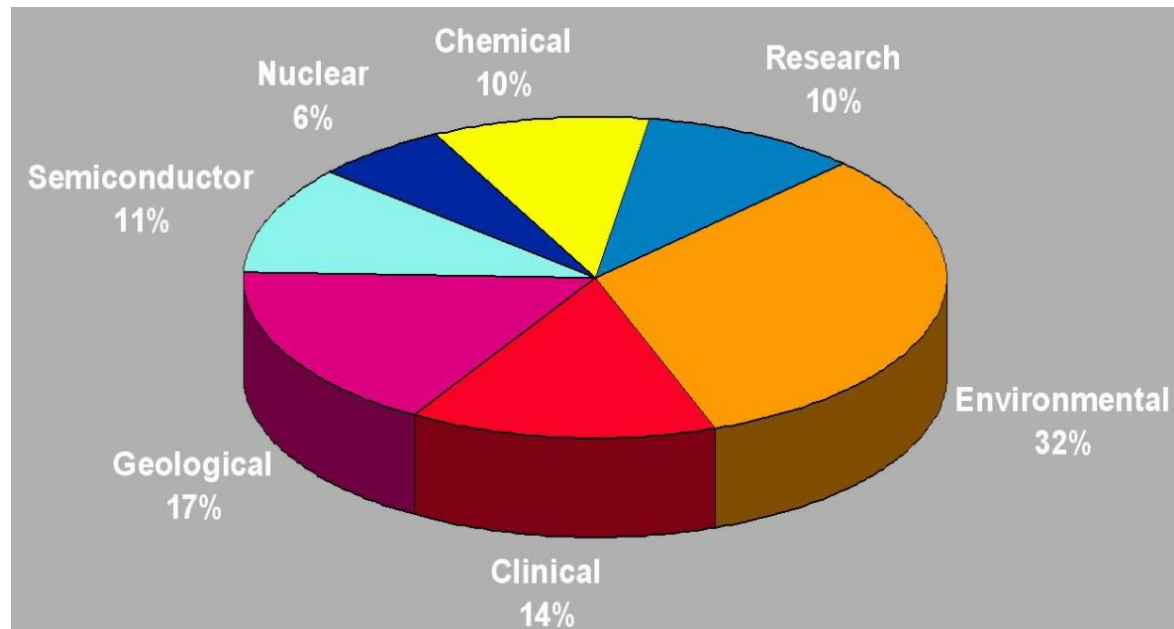
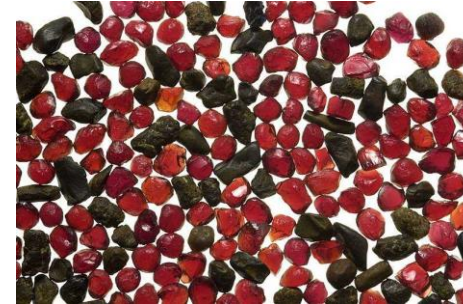

# Mass Spectrometry

in general

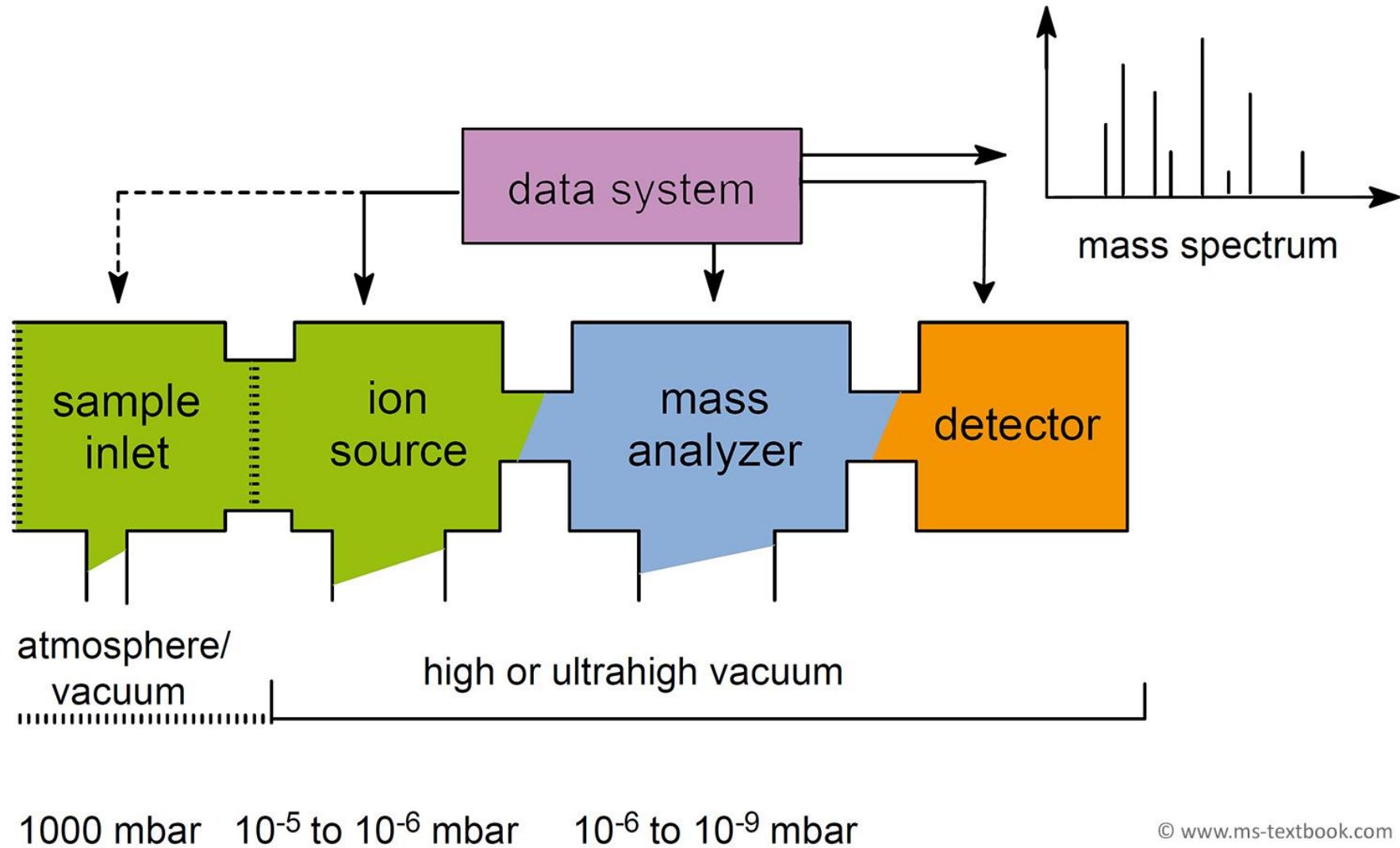



# Mass Spectrometry

history

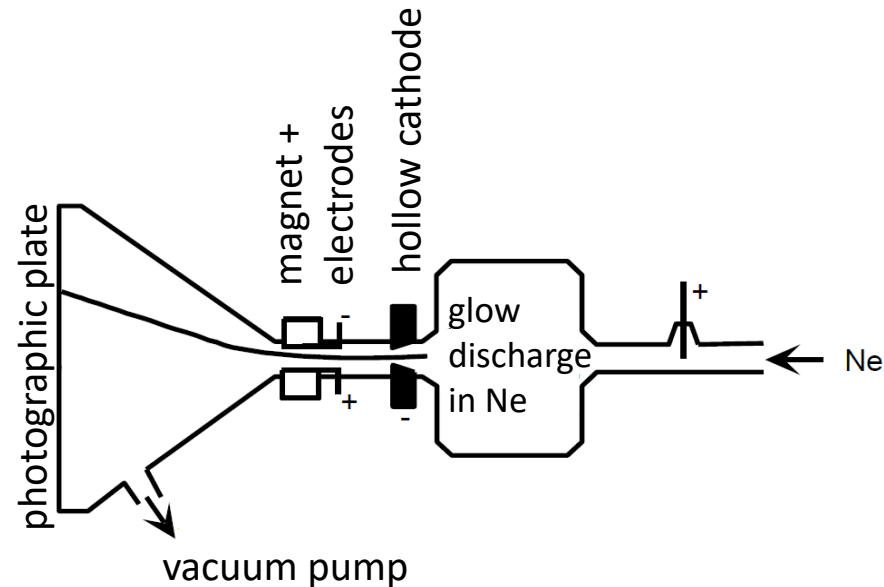
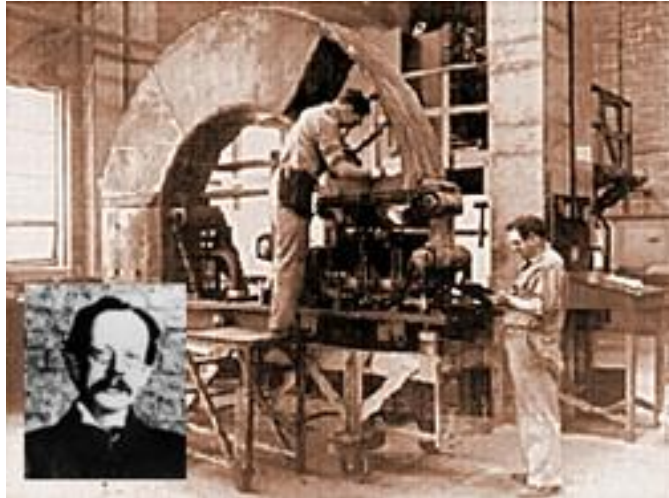

Portrait of Thomson. (Courtesy of the Edgar Fahs Smith Collection/Pennsylvania Library).

The first mass spectrometer - originally called a parabola spectrograph - was constructed in **1912 by J.J. Thomson**, best known for his discovery of the electron in 1897. He used the mass spectrometer to uncover the first evidence for the existence of nonradioactive isotopes. His device for the determination of mass-to-charge ratios of ions was based on turn-of-the-century research on kanalstrahlen, the streams of positive ions formed from residual gases in cathode ray tubes, initially found emitted from channels cut in the cathode plate. Local magnetic and electrostatic fields deflected these positive rays depending on their mass, resulting in diverging traces on a photographic plate.

# Mass Spectrometry

## history

In following decades, the development of mass spectrometry continued (Aston, Dempster, Bainbridge, Nier and others), initially for the purpose of discovering new stable isotopes, determining their representation and exact atomic weight, even before the second world war this technique was used in the study of metabolism.

In the 1940s, mass spectrometry was used in the military as part of the "Manhattan" project in the production of the atomic bomb and as an analytical tool in monitoring the products of the oil industry, which in the following years it started commercial production mass spectrometers, especially in the sector arrangement. Principles of TOF analyzers, ion cyclotron resonance and quadrupole analyzer were described in 1946-1953 and these instruments were also subsequently marketed, although not always initially successfully.

# Mass Spectrometry

## history

The combination of mass spectrometry with **gas chromatography** in the 1960s and with **liquid chromatography** in the 1970s, it heralded a wide use in the multicomponent analysis of complex mixtures of **organic** substances. The possibilities of tandem arrangement for quantitative analysis were also discovered during this period. Main however, the problem lay in the limited possibilities of ionization techniques, when the problem was, for example, the ionization of very polar substances or biomacromolecules. The breakthrough was the introduction of ionization using **electrospray** or **MALDI** in the 1980s, which widened the applicability mass spectrometry for the indicated types of compounds.

# Mass Spectrometry

## history

**Sam Houk** discovered papers from **Alan Gray's** research at the Applied Research Laboratories in England. Gray was experimenting with mass spectrometry using a different plasma source, which sparked Houk's idea of using **inductively coupled plasma for mass spectrometry**. He would just need to build instrumentation that could extract the atoms from the plasma for analysis by the mass spectrometer.

Houk devised, demonstrated and improved an experiment called inductively coupled plasma mass spectrometry (ICP-MS), which can distinguish and measure even trace levels of elements like lead in a sample. No other method can measure such a low of concentration of elements.

In 1977, Houk built the first functional model of an ICP-MS spectrometer, which was a significant advancement in combining plasma technology with mass spectrometry. This spectrometer was named the "**Plasma-Mass Spectrometer**".

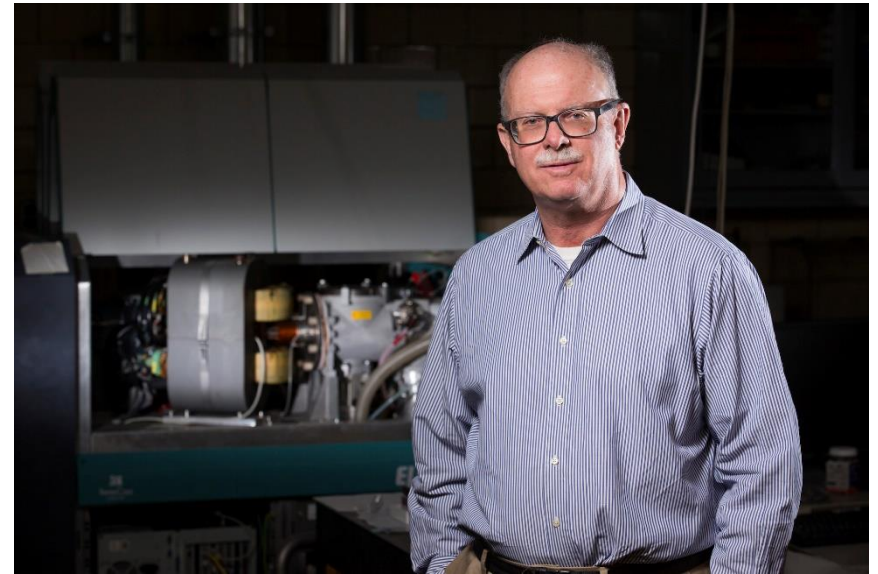

<https://link.las.iastate.edu/2018/04/20/setting-a-standard-for-security/>

# Mass Spectrometry

history



[HOME](#) [PROGRAMME](#) [VENUE](#) [EXHIBITION](#) [REGISTRATION INFO](#) [AWARDS/GRANTS](#) [CONTACTS](#) [PHOTOS](#)

*SL Agilent: ICP-MS/MS, TM Shimadzu Total solutions for food analysis*

16:00 - 18:00

**Ice Breaker EWCPs2017 Winter Market**  
*hosted by platinum, gold and silver sponsors*  
(the local ice-skating rink on-site welcomes EWCPs2017 attendees for a fee of 4 € (skating shoes can be rent for another 4 €))

18:00 - 18:20

**EWCPs2017 Grand Opening**

18:20 - 19:20

Opening lecture

**Sam Houk**

19:20 - 19:30

Spectroscopy Europe Award

given by *Laura Bush (Spectroscopy)*

19:30 - 19:40

Agilent Plasma rising Star Award

given by *Sayuri Otaki (Agilent)*

19:40 - 19:50

Agilent Plasma Award

given by *Sayuri Otaki (Agilent)*

19:50 - 21:40

OPENING Vendors exhibition  
Wine&Cheese and award winner reception

We cordially invite everyone to bring a typical wine of his/her country or one of your favourites.

[CONFERENCE PROCEEDINGS](#)





# Mass Spectrometry

history

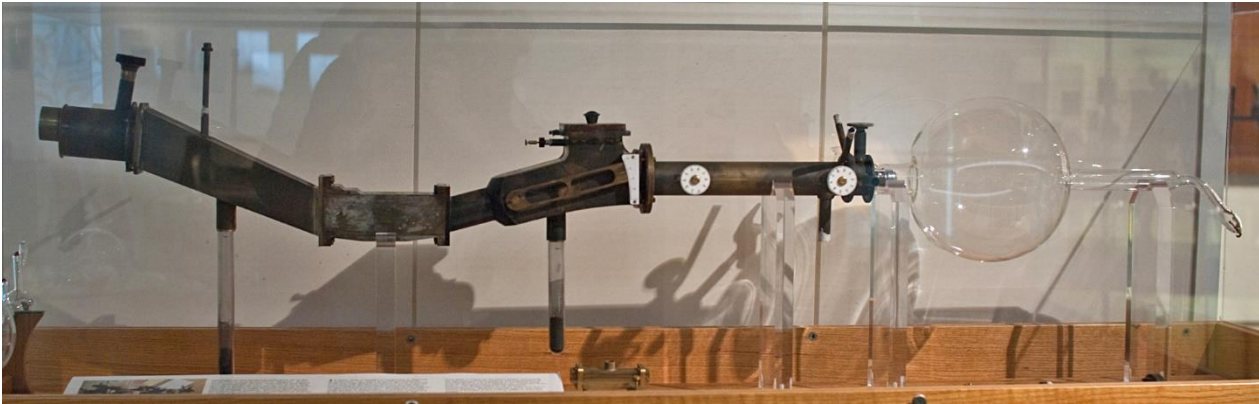

Replica of Francis William Aston's third mass spectrometer.



Inductively Coupled Plasma Mass Spectrometry, [www.thermofisher.com](http://www.thermofisher.com)



"NOAA's "PALMS" instrument aboard the NASA WB-57 high-altitude research aircraft. The Particle Analysis by Laser Mass Spectrometry instrument characterized the chemical composition of seeds in individual cirrus crystals sampled during several research flights over North America and Central America."

[https://commons.wikimedia.org/wiki/File:WB-57\\_PALMS\\_Mount.jpg](https://commons.wikimedia.org/wiki/File:WB-57_PALMS_Mount.jpg)

# Mass Spectrometry

history



*Founders of MS in the Czech Republic:  
RNDr. Vladimír Hanuš, CSc. (1923-2009) and  
RNDr. Vladimír Čermák, DrSc. (1920-1980)*

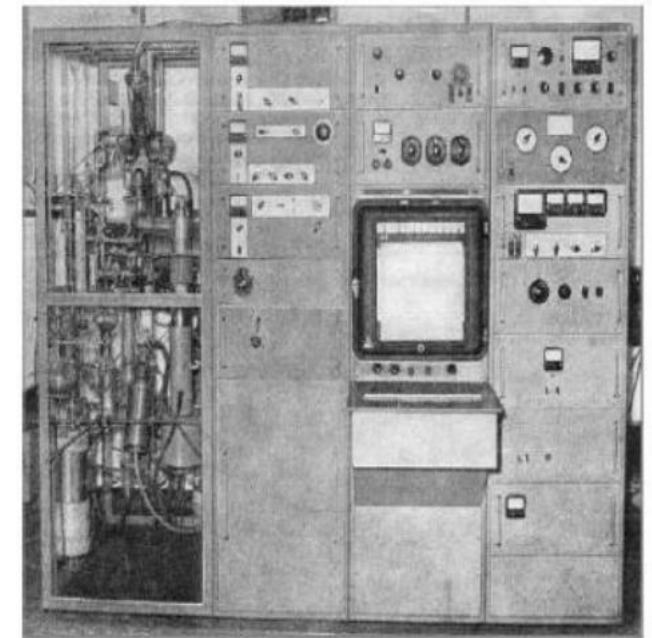
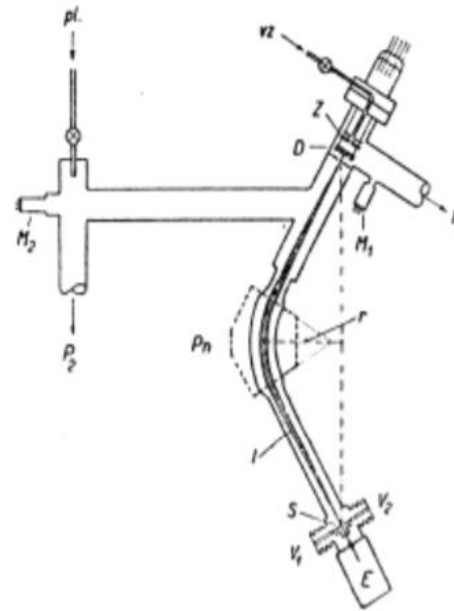

The first mass spectrometer in Czech Republic (ČSSR) – construction by **V. Čermák, V. Hanuš, Č. Jech, J. Cabicar in 1953** at Institute of Physical Chemistry and Electrochemistry of the Czechoslovak Academy of Sciences (ČSAV).