

# **F1190: Proteiny**

doc. Mgr. Karel Kubíček, Ph.D.

# Proteiny

## I] Doporučená literatura

- 1) Whitford, D.: Proteins – Structure and Function, John Wiley & Sons, Ltd. 2005
- 2) Cotterill, R.: Biophysics: An Introduction, John Wiley & Sons, Ltd. 2002
- 3) Voet, D, and Voetová, J.G.: Biochemie, Victoria Publishing
- 4) Murray, R.K., Granner, D. K., Mayes, P., A., Rodwell, V., W.: Harper's Illustrated Biochemistry, Lange Medical Books, 2003
- 5) Schuenemann, V.: Biophysik: Eine Einfuehrung, Springer, 2005
- 6) Garrett, R.H., Grisham, C.M.: Biochemistry, 2<sup>nd</sup> ed., 1999

## II] Aminokyseliny

- 1) Tvoří monomerní jednotky peptidů a proteinů
- 2) 20 L- $\alpha$ -aminokyselin
- 3) Všechny aminokyseliny složeny ze tří částí – **NH<sub>2</sub>**- (amino) skupina, **-COOH** (karboxylová) skupina, **-C <sub>$\alpha$</sub> -R** (alfa uhlík s postranním řetězcem)
- 4) Esenciální a neesenciální kyseliny – organismus si je umí syntetizovat nebo je potřeba je přijímat v potravě
- 5) Označujeme třípísmennými nebo jednopísmennými zkratkami (zápis Val-Thr-Ile-Pro nebo VTIP – u jednopísmenného zápisu bez pomlčky)

# Levels of Protein Structure

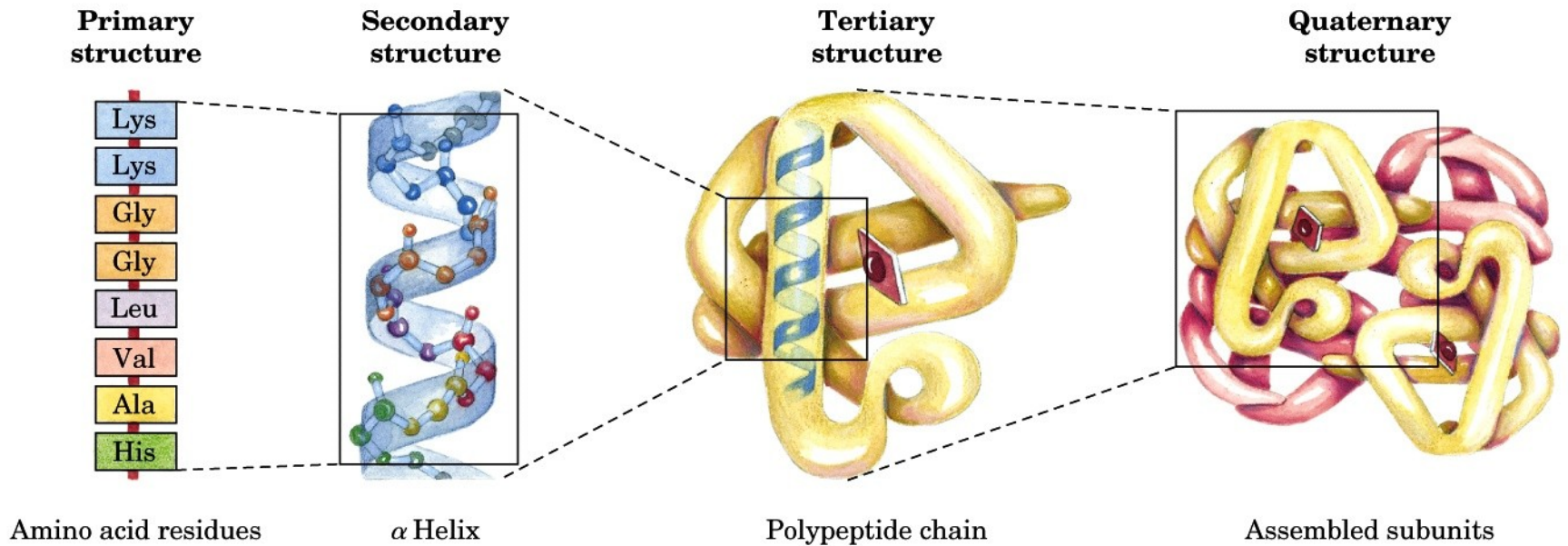

# 6) Aminokyseliny s alifatickým postranním řetězcem

**Glycine  
(Gly)**

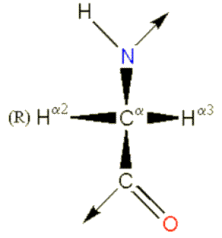

**L-Isoleucine  
(Ile)**

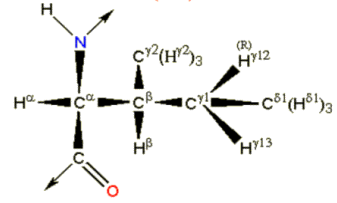

**L-Alanine  
(Ala)**

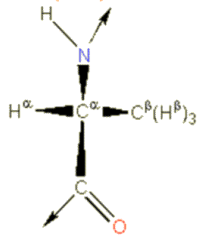

**L-Valine  
(Val)**

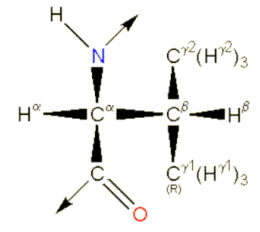

**L-Leucine  
(Leu)**

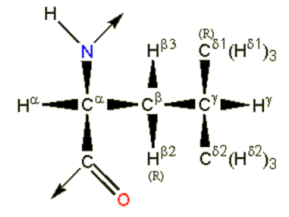

## 7) Aminokyseliny s hydroxylovou (OH) skupinou

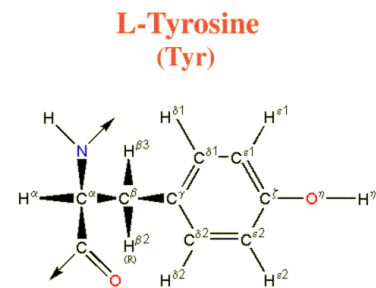
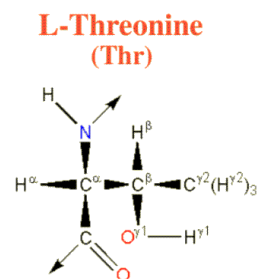
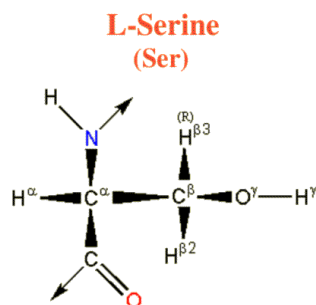

## 8) Aminokyseliny s atomem síry

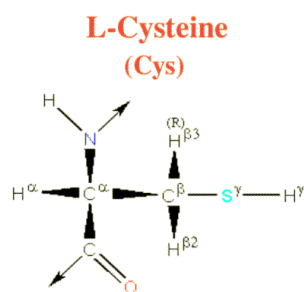
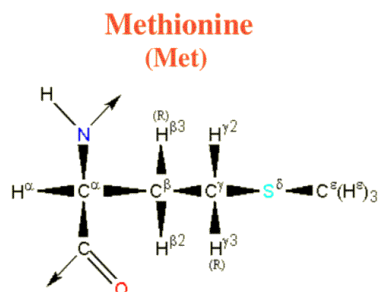

## 9) Aminokyseliny s acidickými skupinami nebo jejich amidy

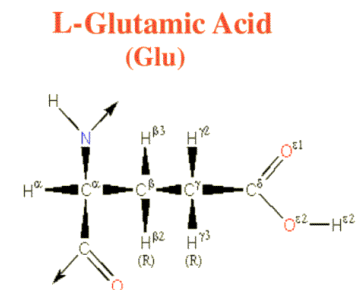
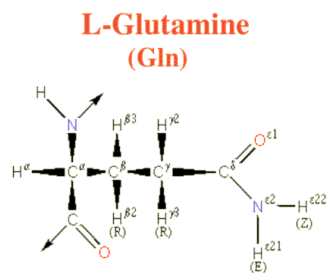
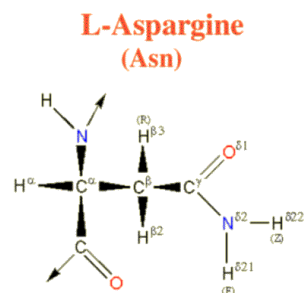

## 10) Imino kyselina

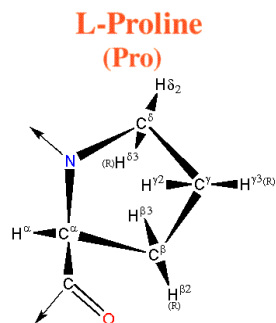

## 11) Aminokyseliny s basickými skupinami

**L-Arginine  
(Arg)**

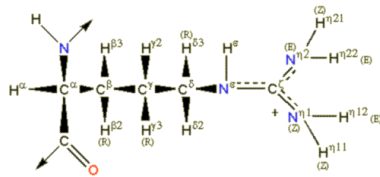

**L-Lysine  
(Lys)**

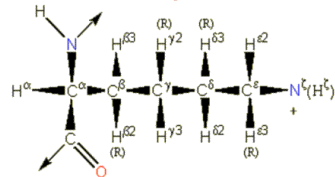

**L-Histidine  
(His)**

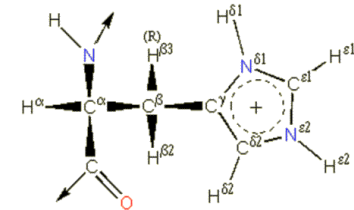

## 12) Aminokyseliny s aromatickými kruhy

**L-Tryptophan  
(Trp)**

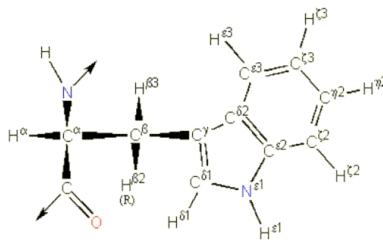

**L-Phenylalanine  
(Phe)**

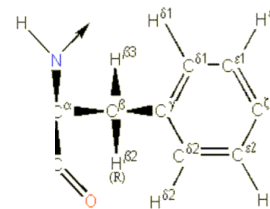

**L-Tyrosine  
(Tyr)**

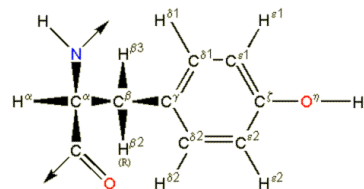

**L-Histidine  
(His)**

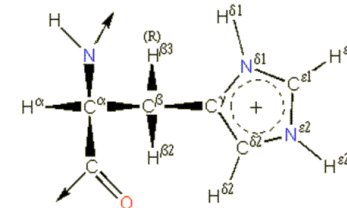

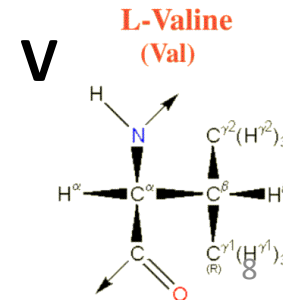
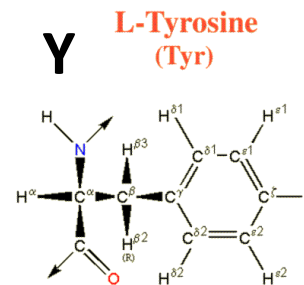
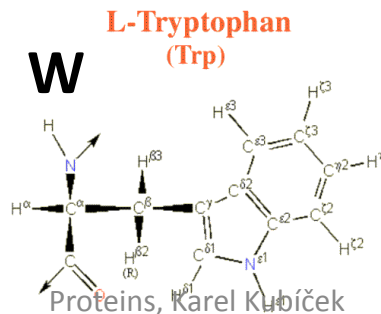
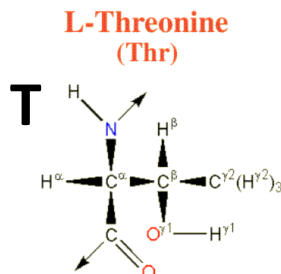
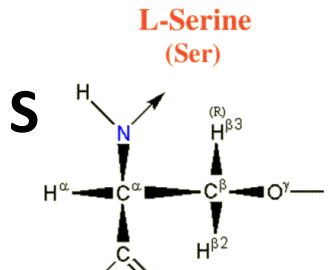
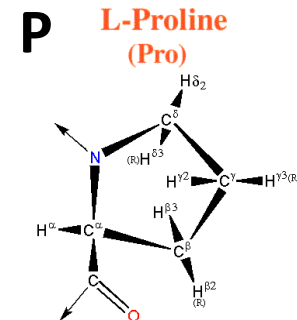
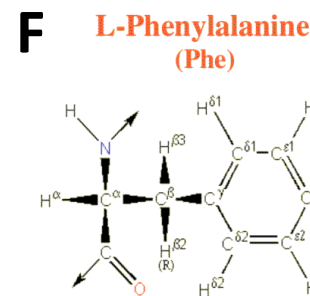
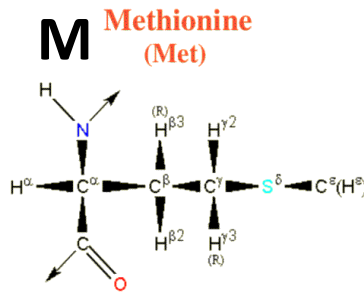
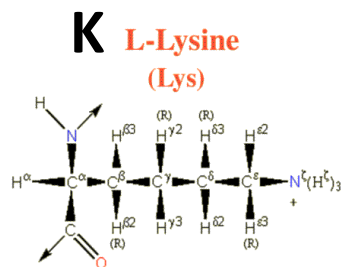
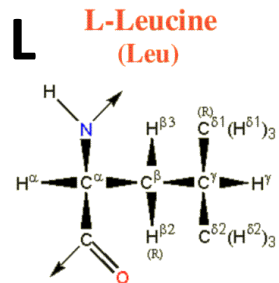
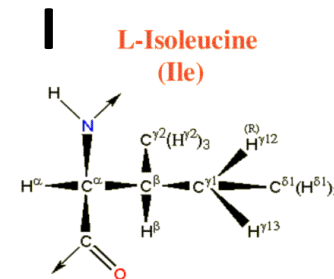
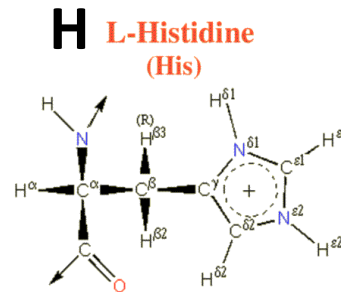
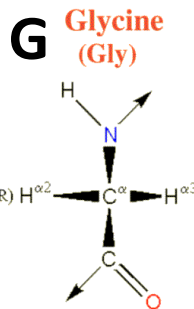
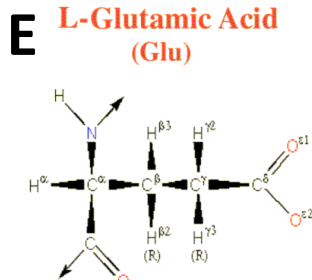
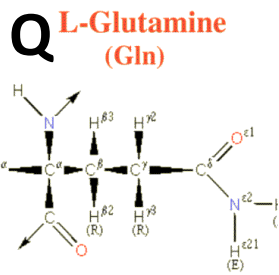
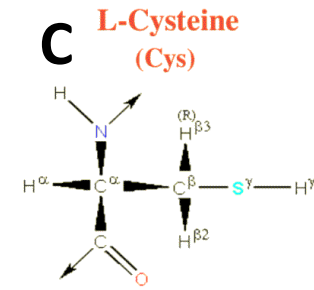
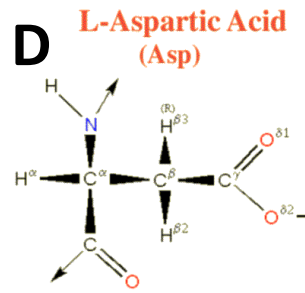
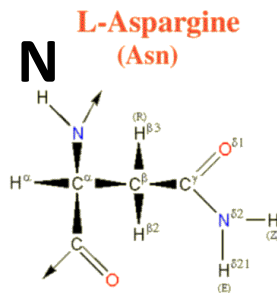
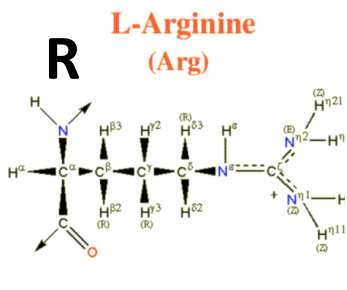
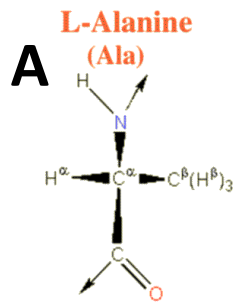



### III] Peptidy, proteiny – vznik polymerů polymerizační reakcí

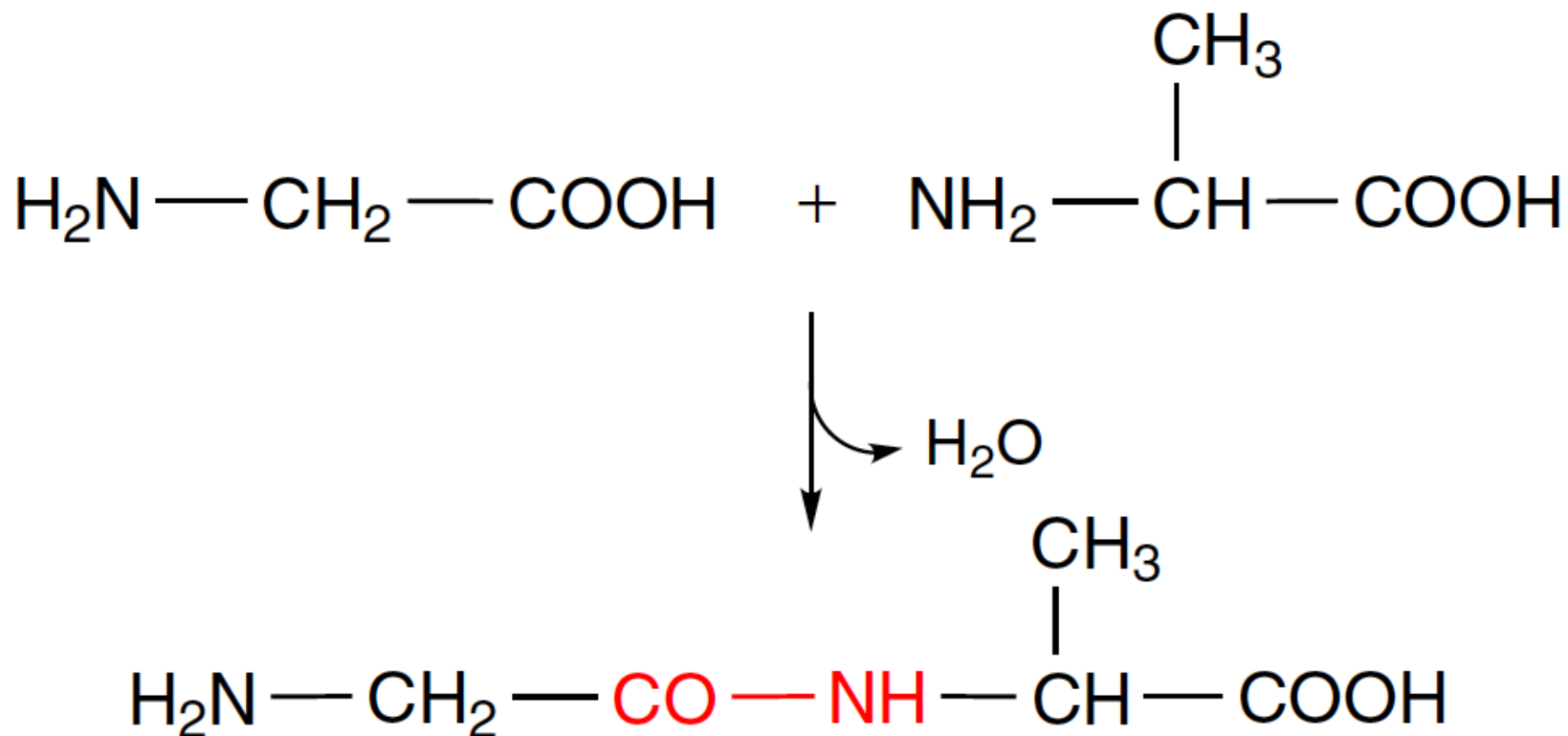

# IV] Peptidová vazba – pseudo dvojitá vazba => amidová rovina

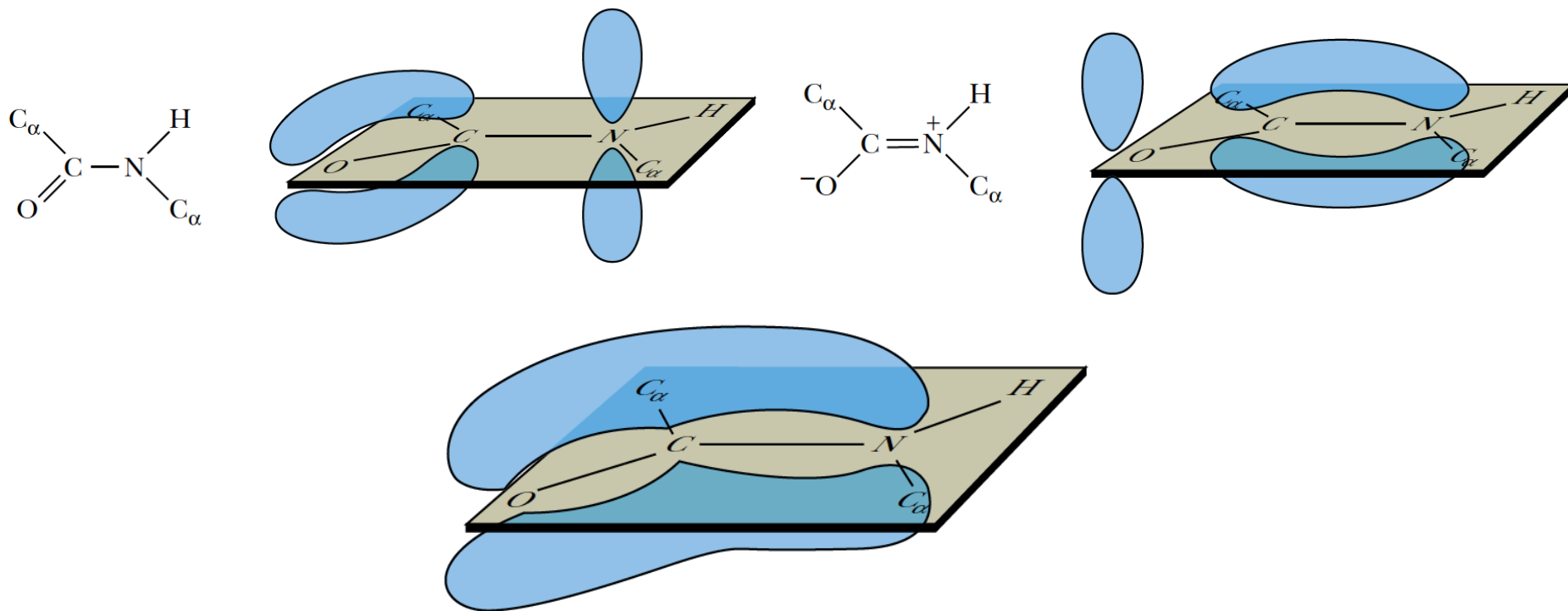
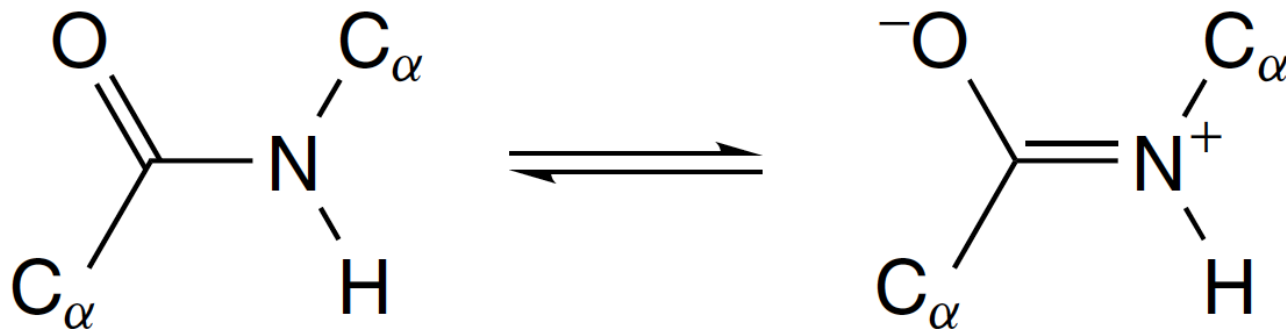

V] Proteinová páteř, primární struktura, číslování od **N**-konce (terminu) směrem k **C**-konci

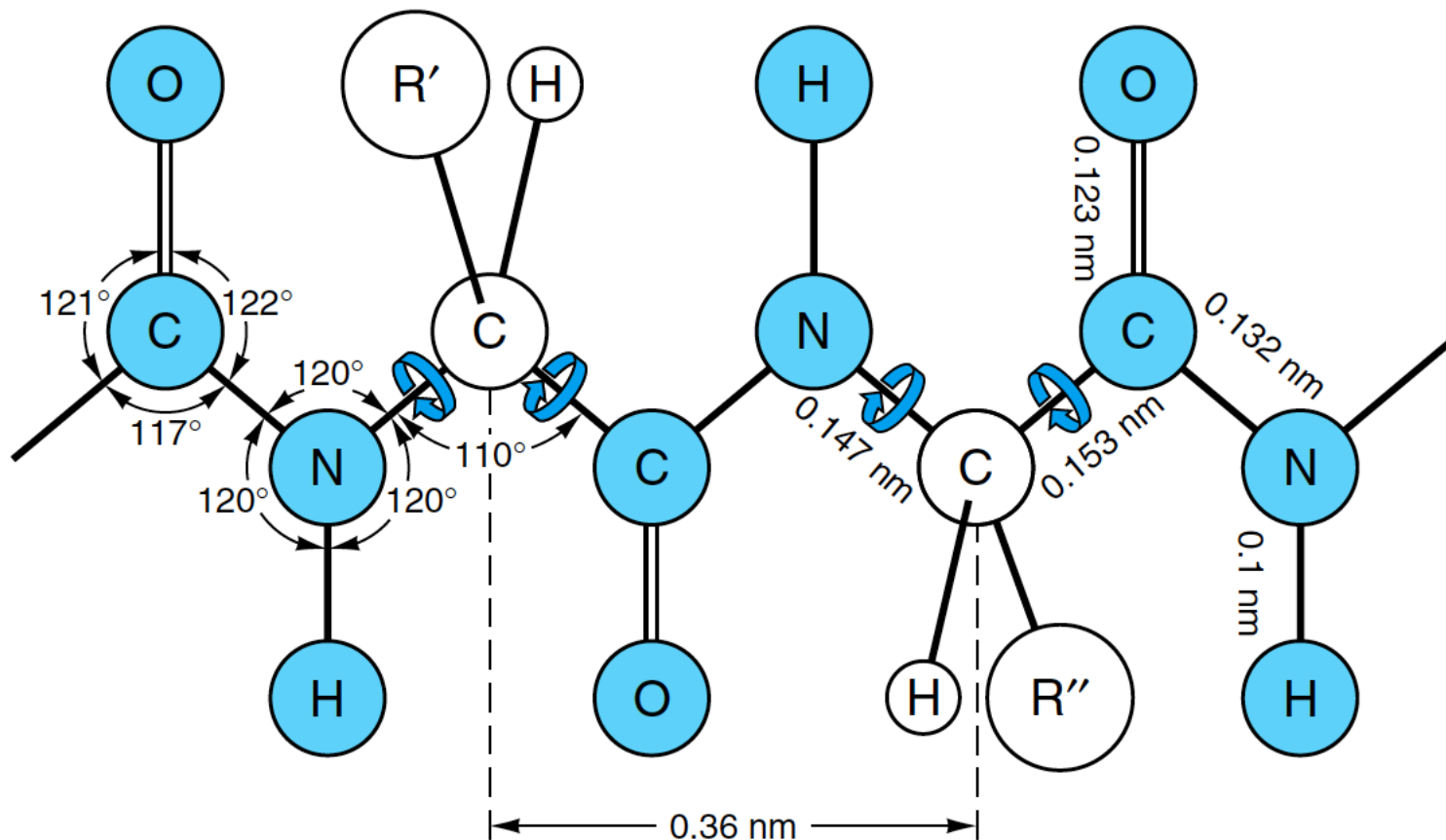

Informace o 3D (proteínové) struktuře jsou zapsány v kartézských souřadnicích  
 Nejrozšířenější formát PDB (ProteinDataBank, [www.pdb.org](http://www.pdb.org) )

ATOM	128	N	HIS	O	18	20.321	6.124	17.761	1.00	11.40
ATOM	129	CA	HIS	O	18	21.097	5.169	18.563	1.00	13.62
ATOM	130	C	HIS	O	18	22.581	5.413	18.454	1.00	17.00
ATOM	131	O	HIS	O	18	23.031	5.592	17.321	1.00	15.45
ATOM	132	CB	HIS	O	18	20.883	3.747	18.034	1.00	16.68
ATOM	133	CG	HIS	O	18	19.557	3.103	18.437	1.00	11.72
ATOM	134	ND1	HIS	O	18	19.252	2.806	19.725	1.00	11.66
ATOM	135	CD2	HIS	O	18	18.479	2.751	17.657	1.00	16.32
ATOM	136	CE1	HIS	O	18	18.021	2.238	19.730	1.00	14.91
ATOM	137	NE2	HIS	O	18	17.552	2.185	18.473	1.00	17.58
HETATM	1633	NC	HEM	O	104	15.182	3.191	16.831	1.00	21.22
HETATM	1634	C1C	HEM	O	104	15.433	3.334	15.488	1.00	17.49
HETATM	1635	C2C	HEM	O	104	15.046	4.605	15.145	1.00	31.21
HETATM	1636	C3C	HEM	O	104	14.623	5.242	16.323	1.00	14.38
HETATM	1637	C4C	HEM	O	104	14.661	4.346	17.360	1.00	14.50
HETATM	1638	CMC	HEM	O	104	15.299	5.349	13.850	1.00	15.54
HETATM	1639	CAC	HEM	O	104	14.314	6.707	16.409	1.00	31.67
HETATM	1640	CBC	HEM	O	104	13.170	7.262	15.615	1.00	10.23
HETATM	1609	FE	HEM	O	104	15.801	1.483	17.954	1.00	9.37

[ftp://ftp.wwpdb.org/pub/pdb/doc/format\\_descriptions/Format\\_v33\\_A4.pdf](ftp://ftp.wwpdb.org/pub/pdb/doc/format_descriptions/Format_v33_A4.pdf)

## Atomic coordinates

$$\mathbf{a}_1 = (a_{1x}, a_{1y}, a_{1z})$$

$$\mathbf{a}_2 = (a_{2x}, a_{2y}, a_{2z})$$

## Bond length

$$b_{12} = ((a_{2x} - a_{1x})^2 + (a_{2y} - a_{1y})^2 + (a_{2z} - a_{1z})^2)^{1/2}$$

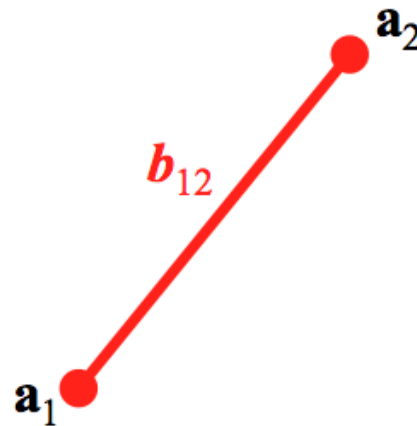

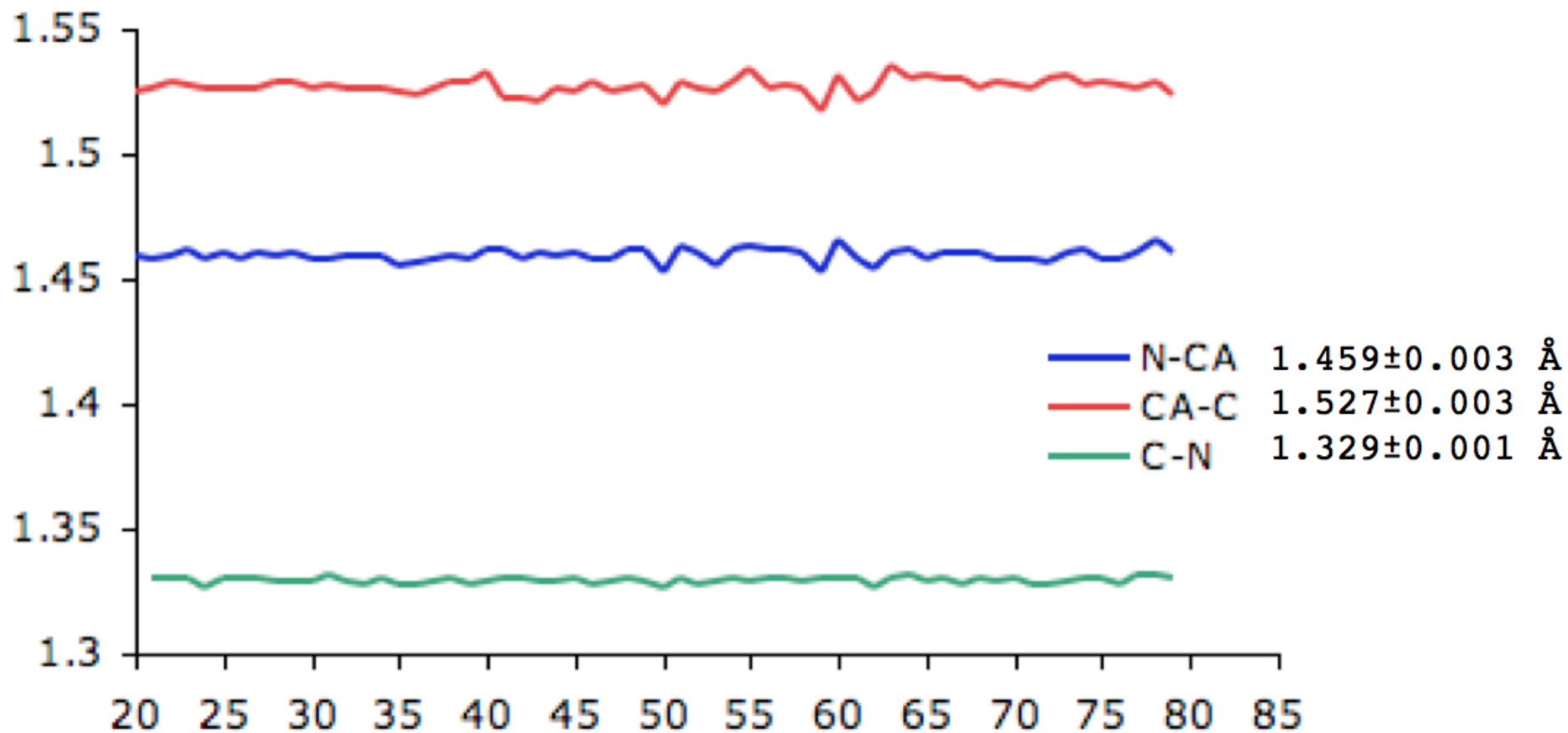

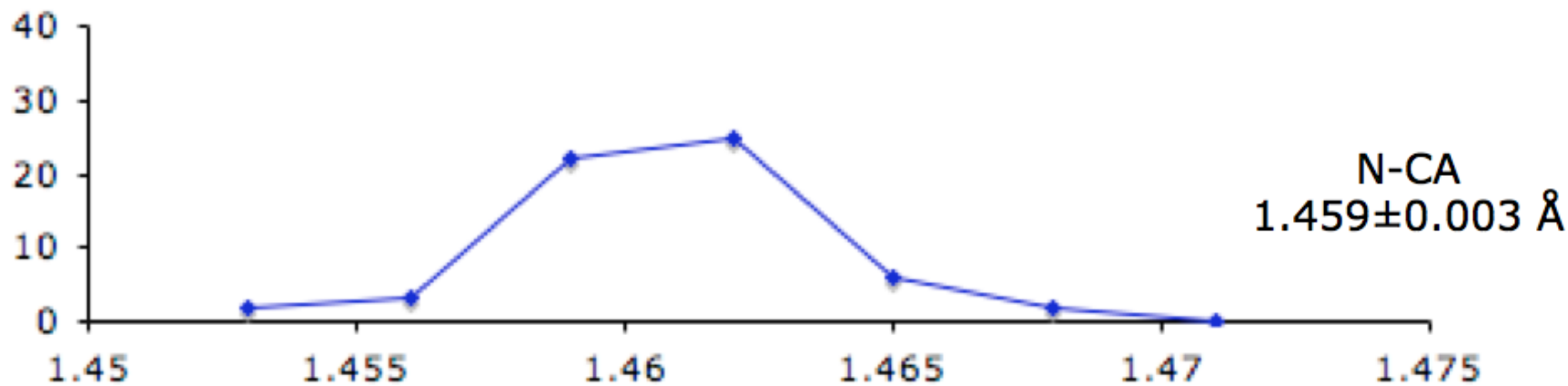
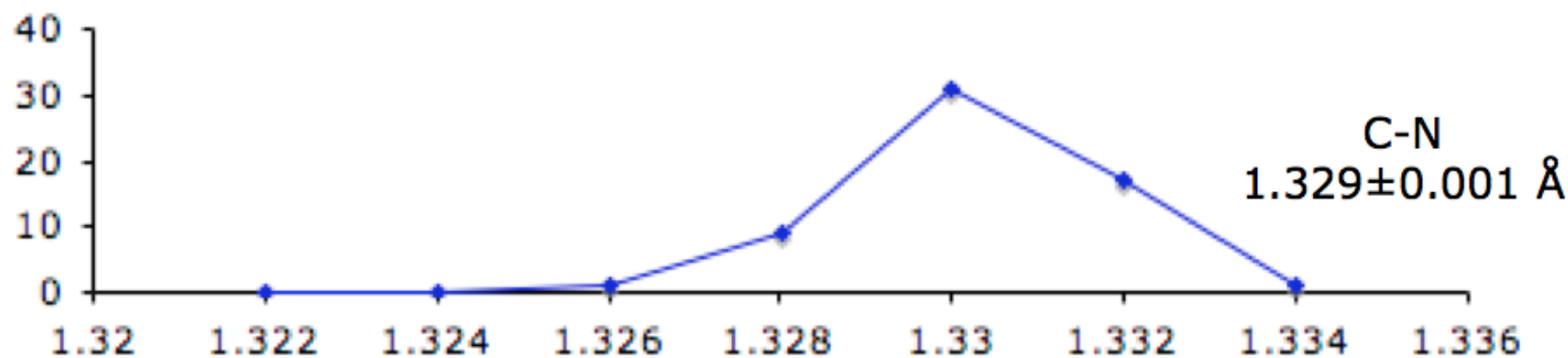
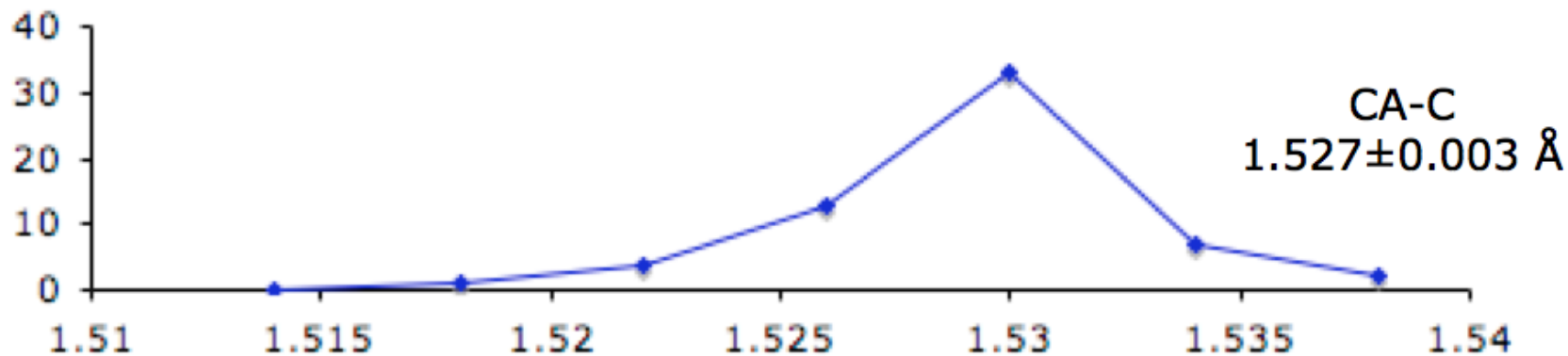

## Atomic coordinates

$$\mathbf{a}_1 = (a_{1x}, a_{1y}, a_{1z})$$

$$\mathbf{a}_2 = (a_{2x}, a_{2y}, a_{2z})$$

$$\mathbf{a}_3 = (a_{3x}, a_{3y}, a_{3z})$$

## Bond vectors

$$\mathbf{b}_{12} = (a_{2x} - a_{1x}, a_{2y} - a_{1y}, a_{2z} - a_{1z})$$

$$\mathbf{b}_{23} = (a_{3x} - a_{2x}, a_{3y} - a_{2y}, a_{3z} - a_{2z})$$

## Scalar product

$$\mathbf{b}_{12} \cdot \mathbf{b}_{23} = (a_{2x} - a_{1x})(a_{3x} - a_{2x}) + (a_{2y} - a_{1y})(a_{3y} - a_{2y}) + (a_{2z} - a_{1z})(a_{3z} - a_{2z})$$

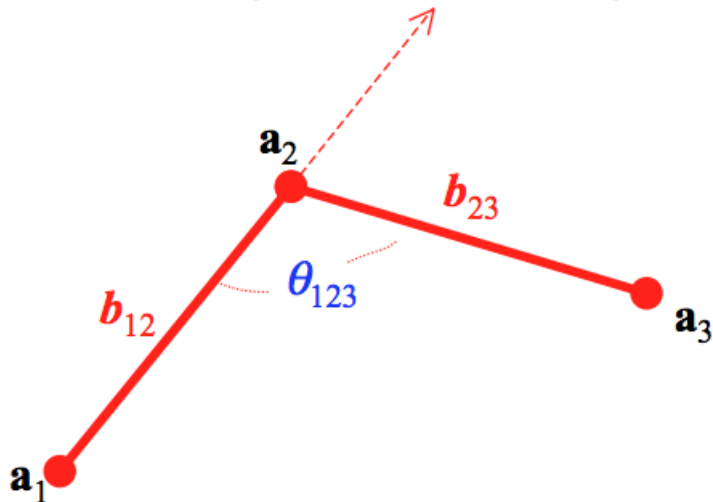

$$\mathbf{b}_{12} \cdot \mathbf{b}_{23} = b_{12} b_{23} \cos(\pi - \theta_{123})$$

$$\cos \theta_{123} = -\mathbf{b}_{12} \cdot \mathbf{b}_{23} / (b_{12} b_{23})$$

$$\cos(\pi - \theta_{123}) = \cos \pi \cos \theta_{123} + \sin \pi \sin \theta_{123} = -\cos \theta_{123}$$



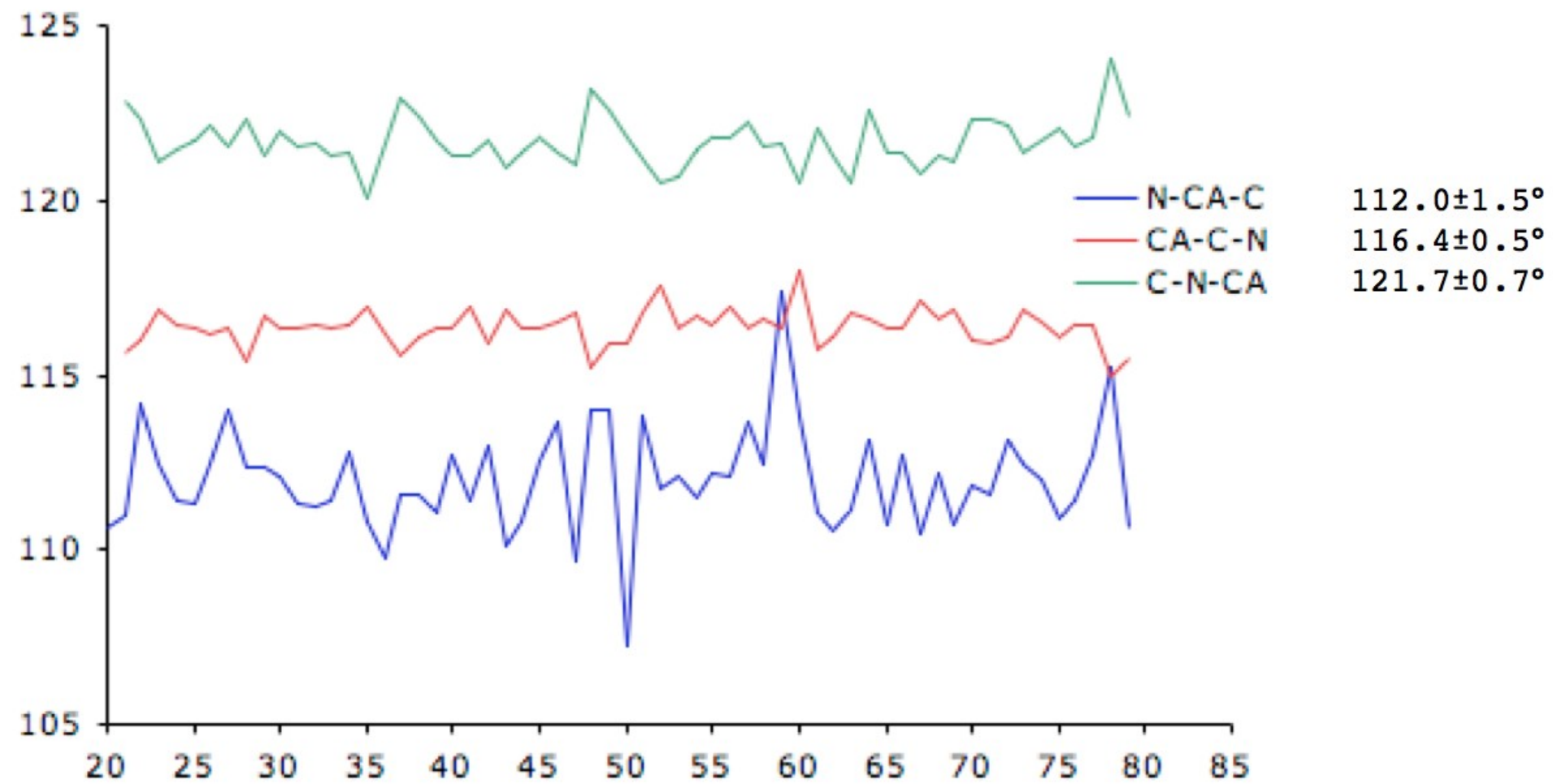

### Atomic coordinates

$$\mathbf{a}_1 = (a_{1x}, a_{1y}, a_{1z}) \quad \mathbf{a}_2 = (a_{2x}, a_{2y}, a_{2z}) \quad \mathbf{a}_3 = (a_{3x}, a_{3y}, a_{3z}) \quad \mathbf{a}_4 = (a_{4x}, a_{4y}, a_{4z})$$

### Bond vectors

$$\mathbf{b}_{12} = (a_{2x} - a_{1x}, a_{2y} - a_{1y}, a_{2z} - a_{1z}) \quad \mathbf{b}_{23} = (a_{3x} - a_{2x}, a_{3y} - a_{2y}, a_{3z} - a_{2z}) \quad \mathbf{b}_{34} = (a_{4x} - a_{3x}, a_{4y} - a_{3y}, a_{4z} - a_{3z})$$

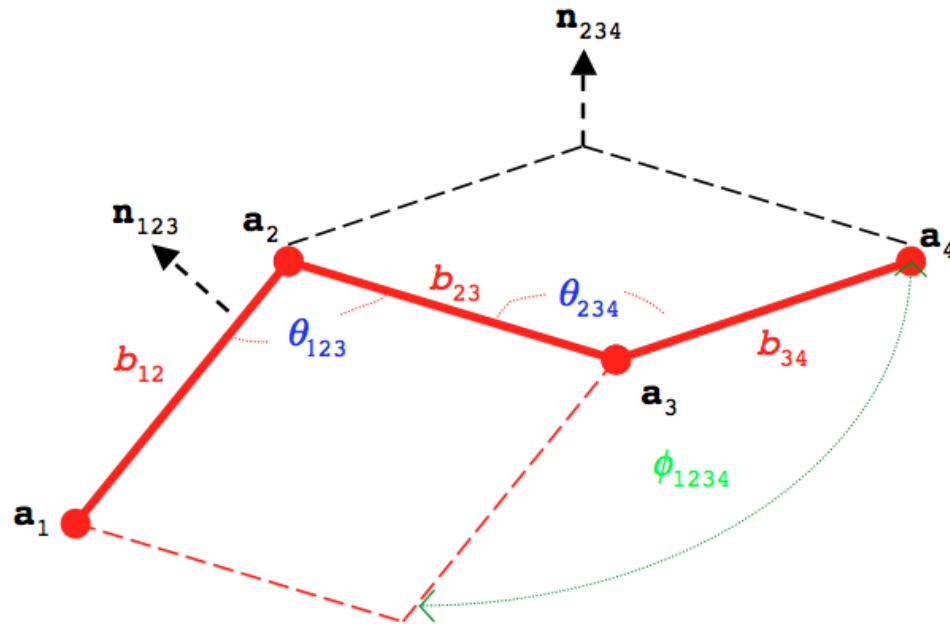

$$\mathbf{n}_{123} = \mathbf{b}_{12} \times \mathbf{b}_{23}$$

$$\mathbf{n}_{234} = \mathbf{b}_{23} \times \mathbf{b}_{34}$$

$$\mathbf{n}_{123} \cdot \mathbf{n}_{234} = \cos \phi_{1234}$$

$$(\mathbf{n}_{123} \times \mathbf{n}_{234}) \cdot \mathbf{b}_{23} > 0 \Rightarrow \phi_{1234} > 0$$

$$(\mathbf{n}_{123} \times \mathbf{n}_{234}) \cdot \mathbf{b}_{23} < 0 \Rightarrow \phi_{1234} < 0$$

$$\mathbf{v}_1 \times \mathbf{v}_2 = \begin{vmatrix} i & j & k \\ v_{1x} & v_{1y} & v_{1z} \\ v_{2x} & v_{2y} & v_{2z} \end{vmatrix}$$

$$= \left( v_{1y}v_{2z} - v_{2y}v_{1z} \right) i + \left( v_{1z}v_{2x} - v_{2z}v_{1x} \right) j + \left( v_{1x}v_{2y} - v_{2x}v_{1y} \right) k$$

$$= \left[ \left( v_{1y}v_{2z} - v_{2y}v_{1z} \right), \left( v_{1z}v_{2x} - v_{2z}v_{1x} \right), \left( v_{1x}v_{2y} - v_{2x}v_{1y} \right) \right]$$

$$= (c_1, c_2, c_3)$$

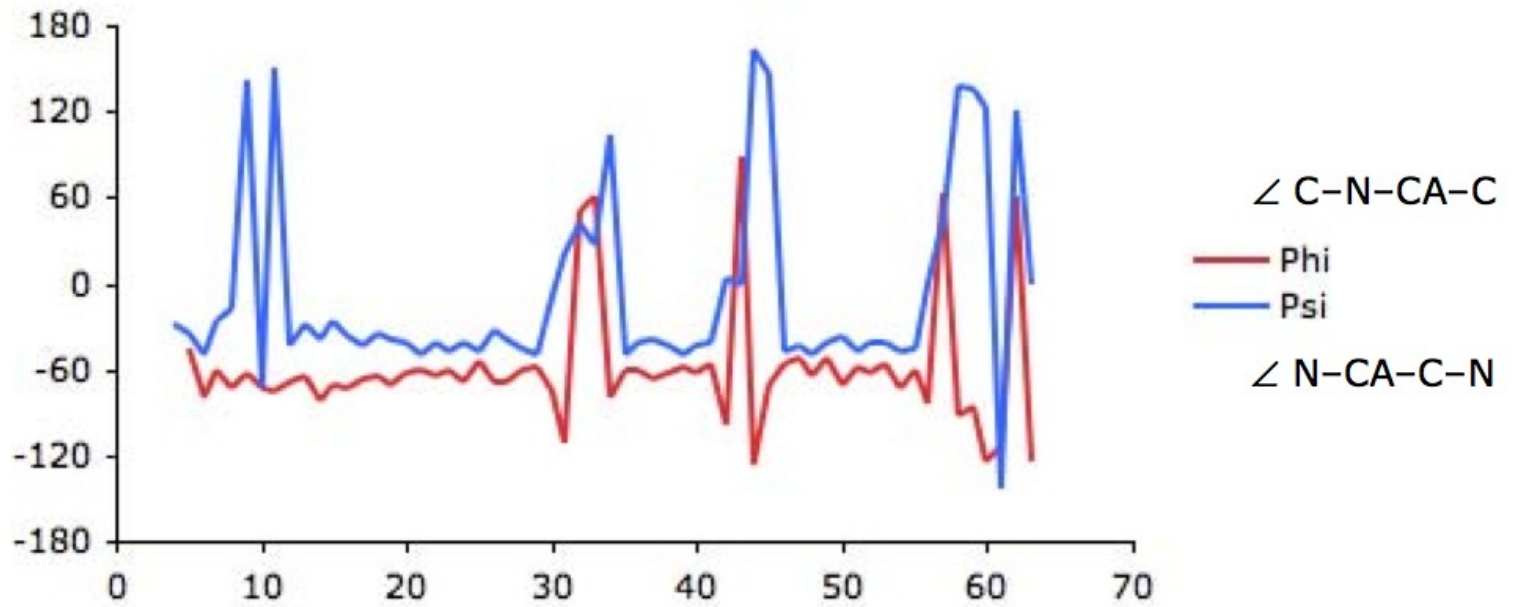
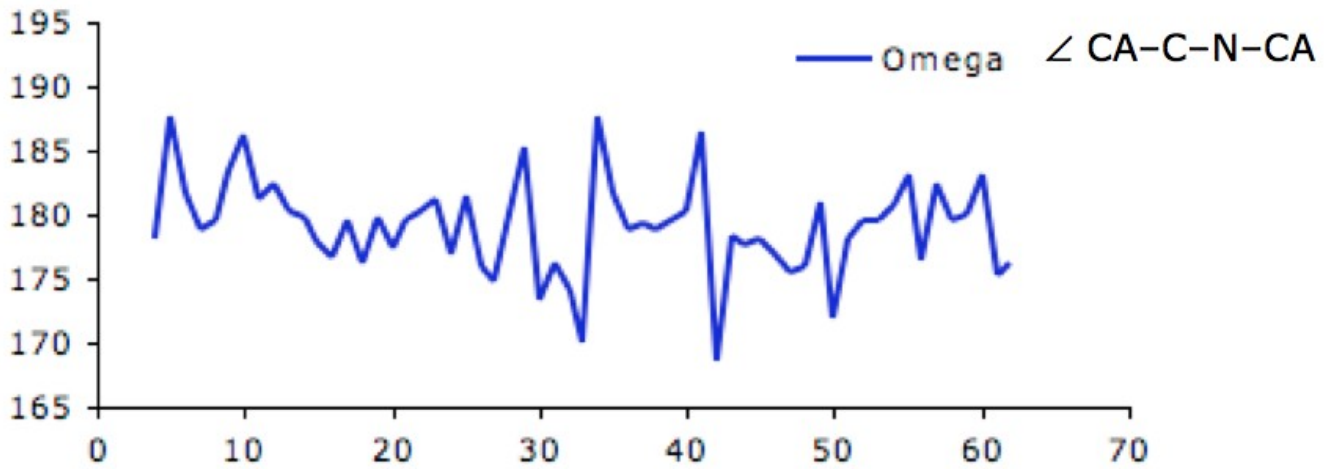

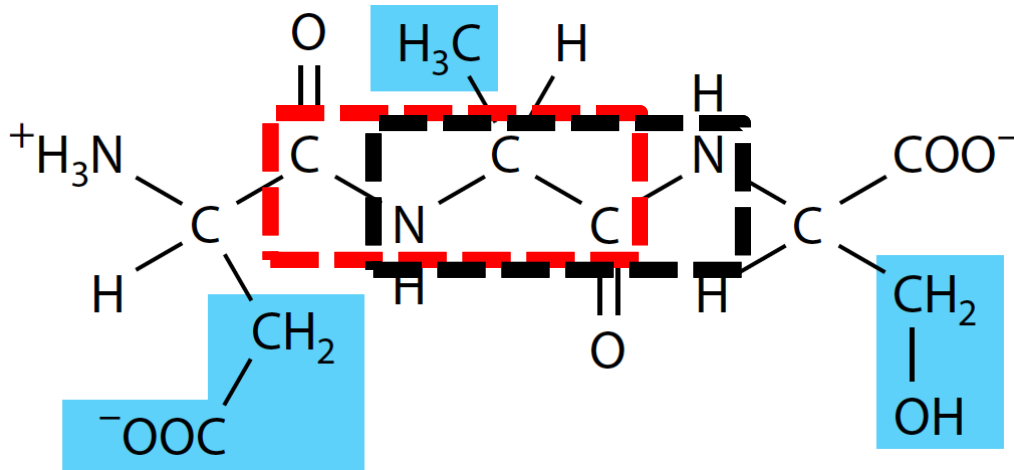
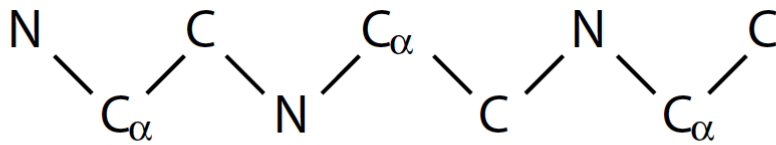

$\phi$  — CO, N, C<sub>α</sub>, CO (CO někdy značeno C')

$\psi$  — N, C<sub>α</sub>, CO, N

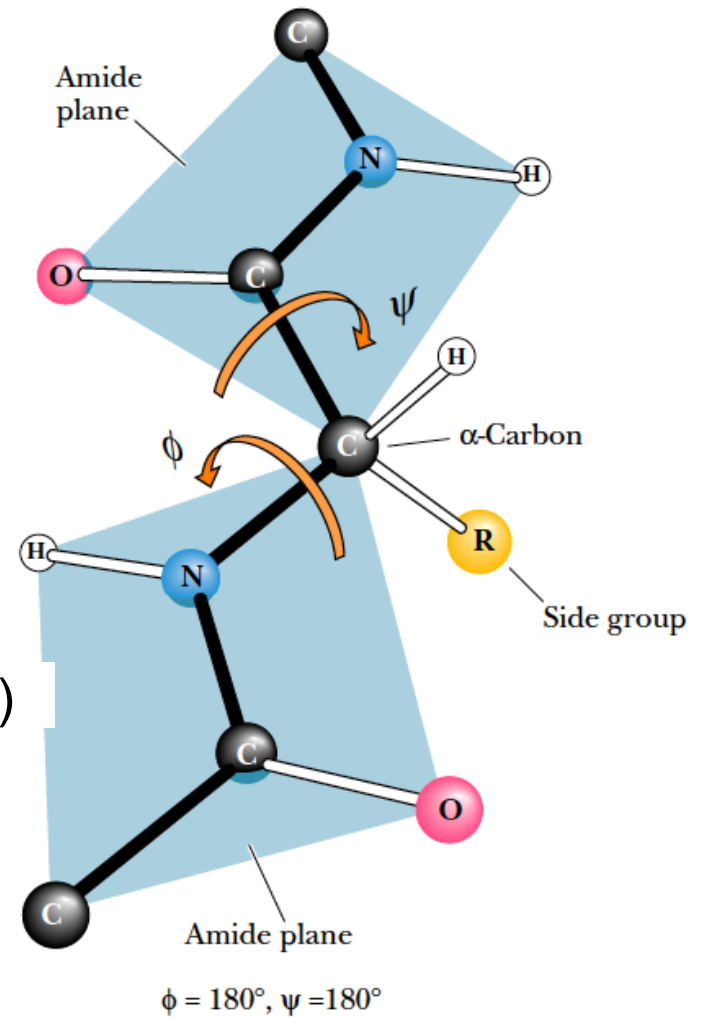

# Structural parameters for protein secondary structures

Structural element	$\phi$	$\psi$	$n$	$d$	$p$
$\alpha$ -helix	-57	-47	3.6	1.5	5.5
$3_{10}$ -helix	-49	-26	3.0	2.0	6.0
$\beta$ -helix	-57	-70	4.4	1.1	5.0
Polyproline II helix	-79	+149	3.0	3.1	9.4
Parallel $\beta$ -strand	-119	+113	2.0	3.2	6.4
Antiparallel $\beta$ -strand	-139	+135	2.0	3.4	6.8

$\phi$  and  $\psi$  are the conformational angles of the mainchain, with  $\omega \sim 180^\circ$  (trans conformation)

$n$  = number of residues per turn

$d$  = displacement between successive residues along the helix/strand axis

$p$  = the pitch of helix/strand, the distance along the helix/strand axis of a complete sec. struct. element. Note that  $p = n \times d$  (equation is exact, error is in rounding of  $n$  and  $d$ )

## VI] Ramachandranův diagram

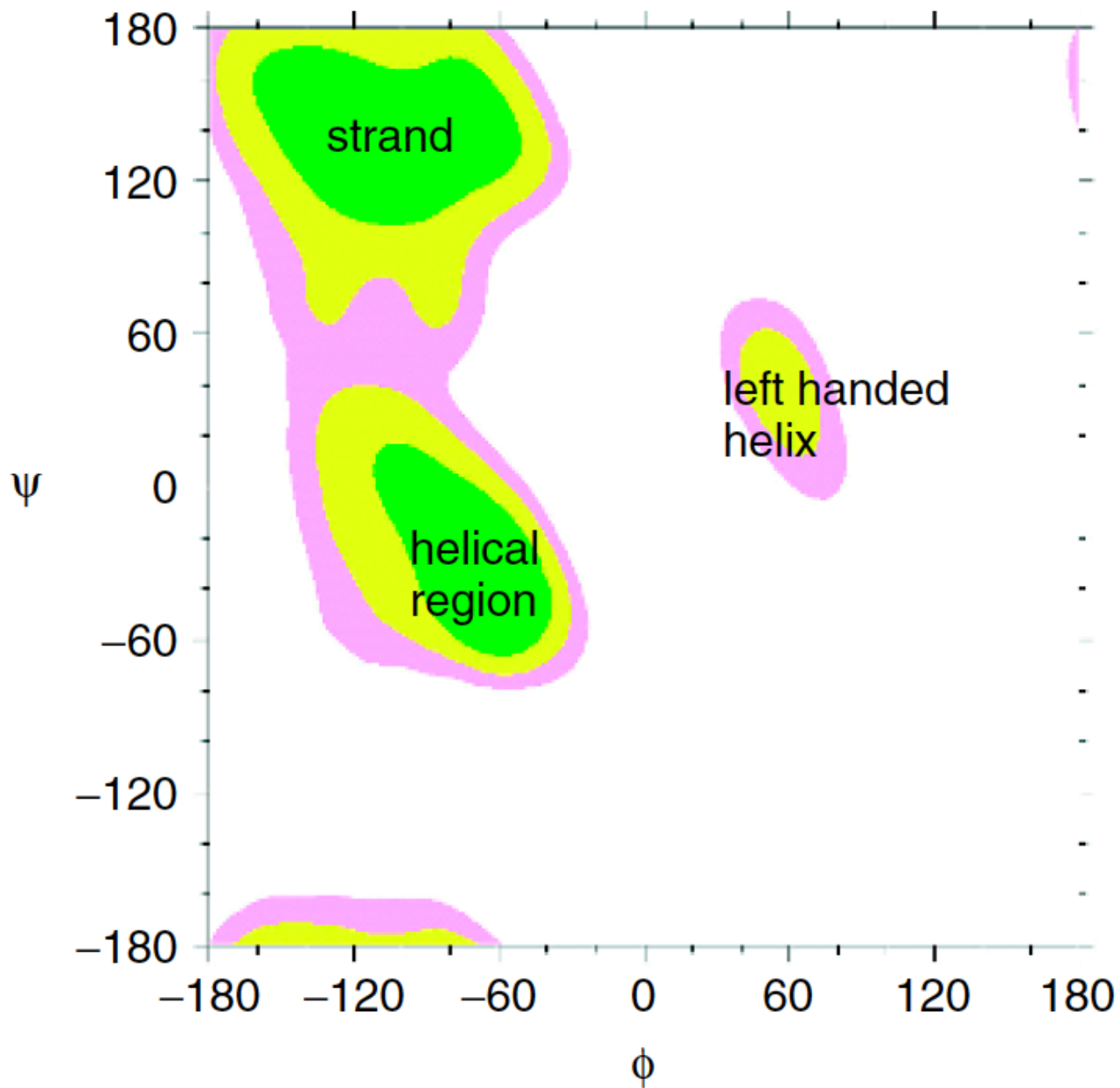

# Ramachandranův diagram – komplet

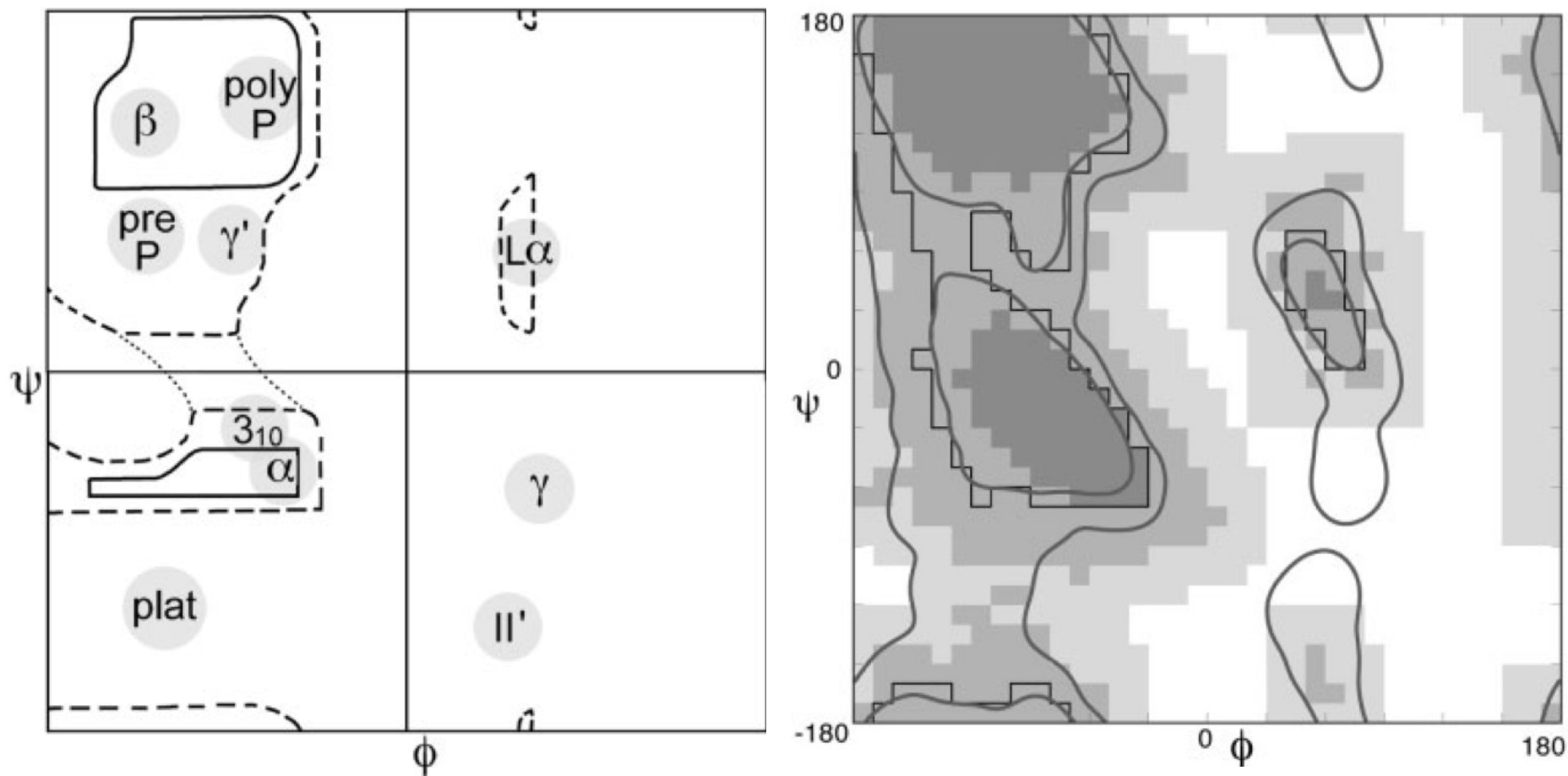



## Tutorial:Ramachandran principle and phi psi angles

### The Ramachandran Principle Phi ( $\phi$ ) and Psi ( $\psi$ ) Angles in Proteins

The Ramachandran Principle says that **alpha helices, beta strands, and turns** are the most likely conformations for a **polypeptide chain** to adopt, because most other conformations are impossible due to steric collisions between atoms.

This interactive tutorial is also available as an [Animated Slideshow](#) or [YouTube Video](#) , and there is a [Quiz](#).

At right is a fragment of a **polypeptide chain**. In the center is a single complete alanine residue. Check **Alanine** to identify its atoms<sup>1</sup>. The other atoms are fragments of adjacent **amino acids**<sup>2</sup>. *Drag with your mouse to rotate the model.*

The Alanine is covalently bonded to other amino acids through **peptide bonds**. Check **Peptide Bonds** to locate them.

The double bonds between **main chain (backbone)** **C** and **O** delocalize, making the peptide bonds also have partial double bonds (*half-dotted bonds*). This prevents the peptide bond from rotating.

Each peptide bond holds six atoms in a plane. Check **Planes** to see them.

The **alpha carbon (C $\alpha$ )** in the center of each amino acid is held in the main chain by two rotatable bonds. The **dihedral (torsion) angles** of these bonds are called<sup>3</sup> **Phi** and **Psi** (in Greek letters,  $\phi$  and  $\psi$ ). *Use the radio buttons (top of right panel) to identify the rotatable main-chain bonds, and click the **-20°** and **+20°** buttons to see them rotate.*

Click the **Reset** button.

The balls shown are much smaller than the atoms they represent. Check **van der Waals** to see the real sizes of the atoms<sup>4</sup>. In fact, most **Phi** and **Psi** angle combinations are impossible because two atoms cannot occupy the same space.

Check **Show Clashes** to see where non-bonded atoms are overlapping, and thus in physically impossible positions. (This model simulation allows two atoms to overlap, unlike real atoms.)

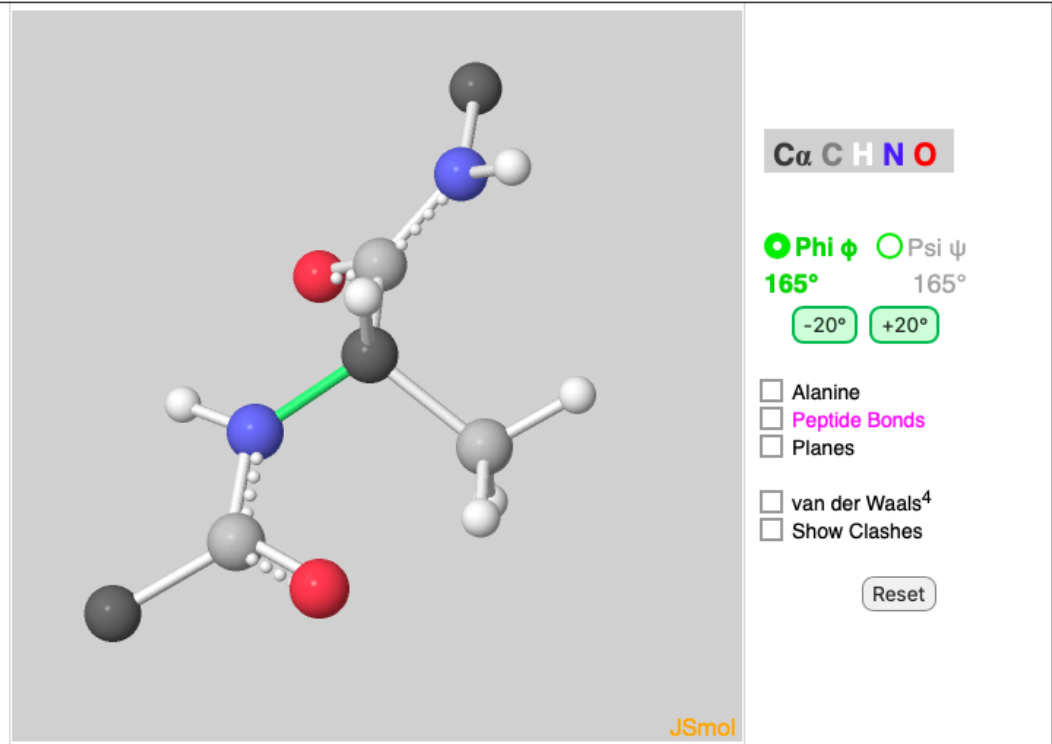



**Figure 7.1.** Sir John Kendrew with the model of insulin, one of the first protein structures to be determined by X-ray crystallography. Components of the actual model are just visible through the forest of vertical support rods.

# The $\alpha$ helix has a dipole moment

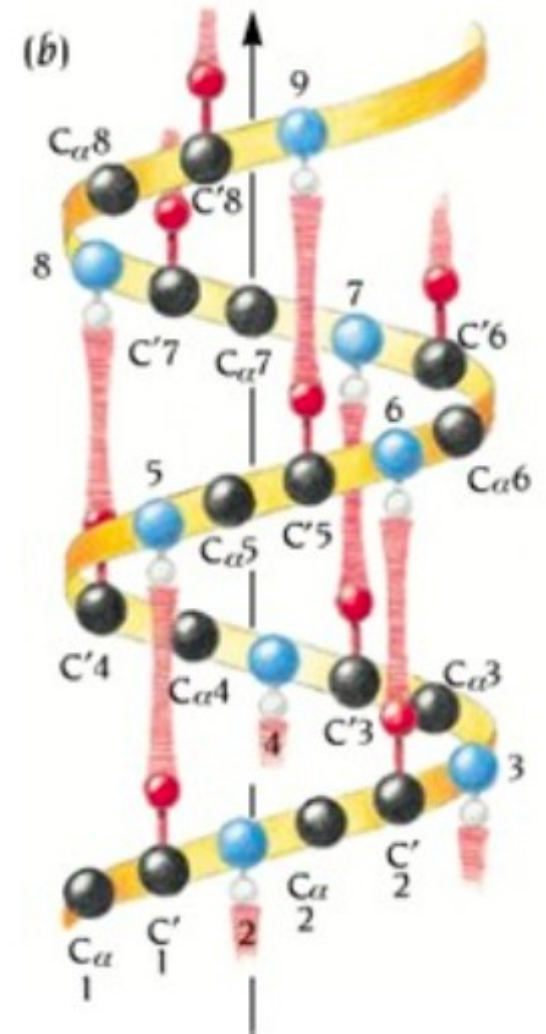
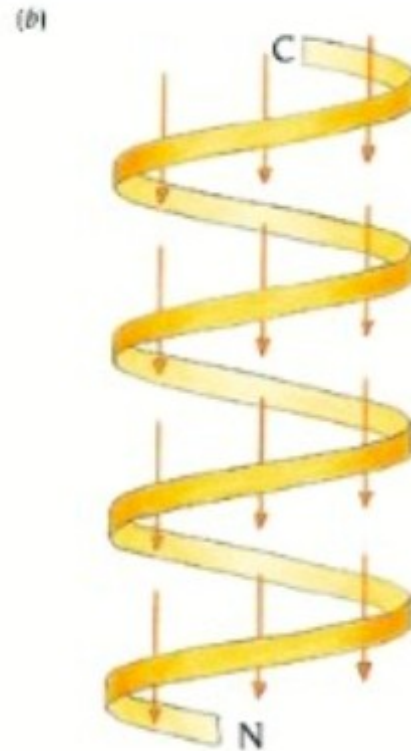
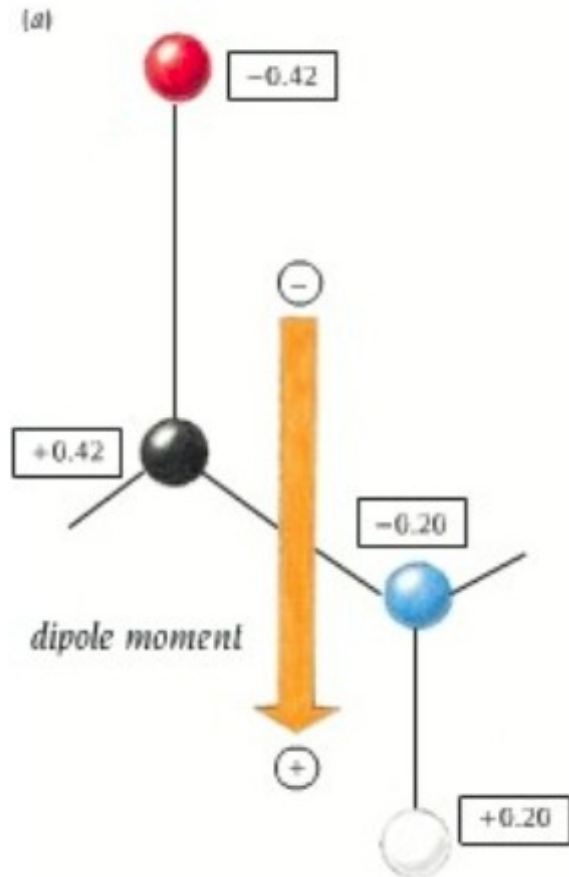

## VII] Sekundární struktura

### 1) $\alpha$ -šroubovice ( $\alpha$ -helix)

2)  $\beta$ -skládání list (beta-sheet)

3) Ohyb, smyčka (loop/turn)

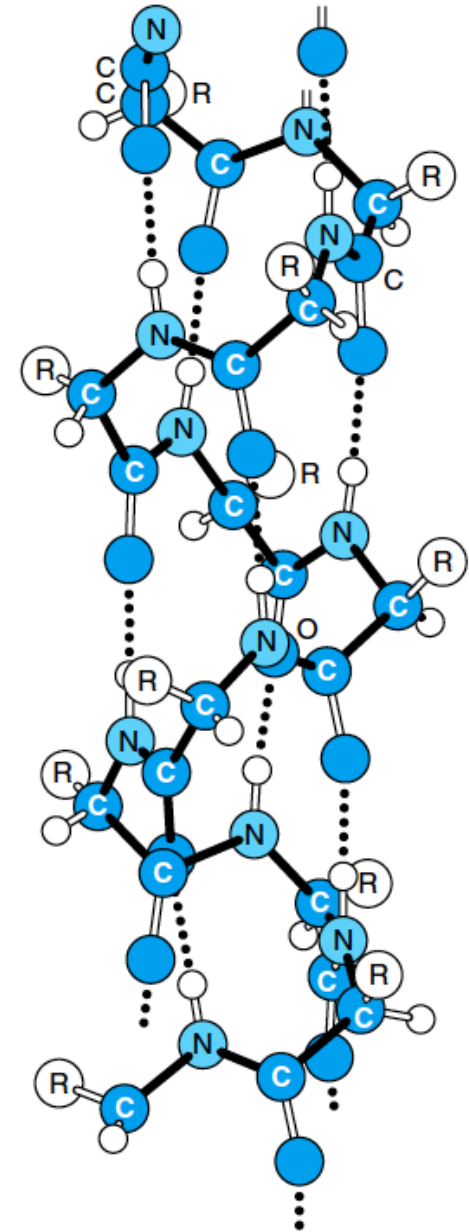
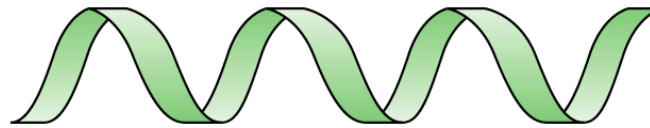
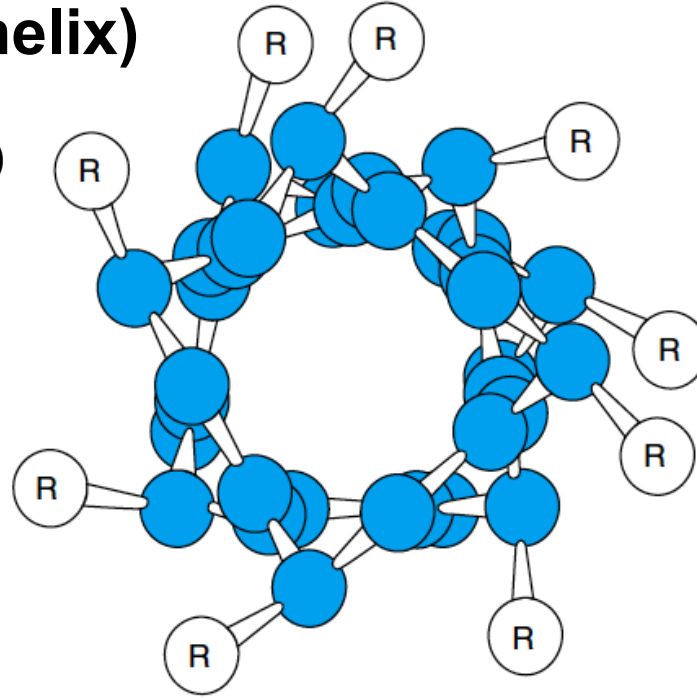
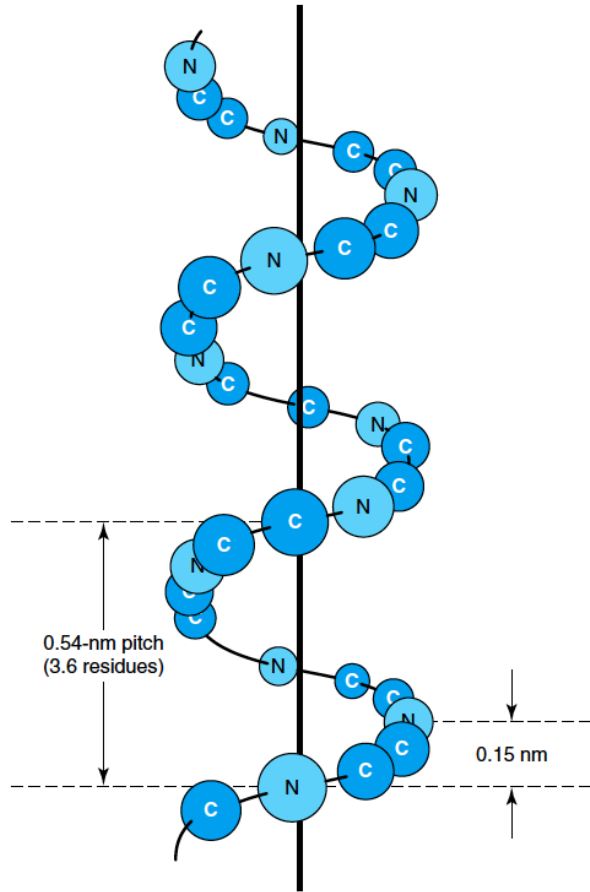

# $3_{10}$ helix, $\alpha$ helix, $\pi$ helix

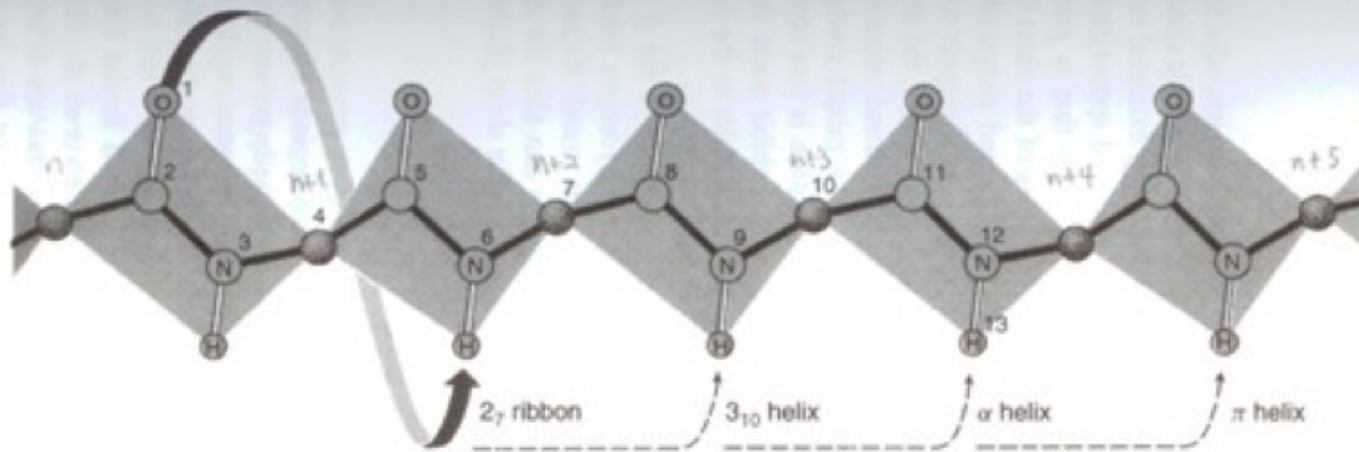

**Figure 2.8.** The hydrogen bonding patterns of different helical secondary structures. The peptide backbone is shown in an extended conformation, with an arrow denoting the hydrogen bonding pairings that would occur in each type of helix. The common  $\alpha$  helix, depicted in Figure 2.7, forms hydrogen bonds between the carbonyl oxygen of each residue and the amide proton of the residue 4 residues ahead in the helix. The  $3_{10}$  helix forms hydrogen bonds between the carbonyl oxygen of each residue and the amide proton of the residue 3 residues ahead, forming a more narrow and elongated helix. The  $\pi$  helix forms hydrogen bonds between the carbonyl oxygen of each residue and the amide proton of the residue five residues ahead, forming a wider helix. The  $2_7$  ribbon is not a regular secondary structure, but is shown here to demonstrate all possible hydrogen bond pairings. From R. E. Dickerson and I. Geis. *The Structure and Action of Proteins*. New York: Harper & Row, 1969. Used with permission from Geis Archives.

# VII] Sekundární struktura

- 1)  $\alpha$ -šroubovice ( $\alpha$ -helix)
- 2)  $\beta$ -skládání list (  $\beta$ -sheet)
- 3) Ohyb, smyčka (turn)

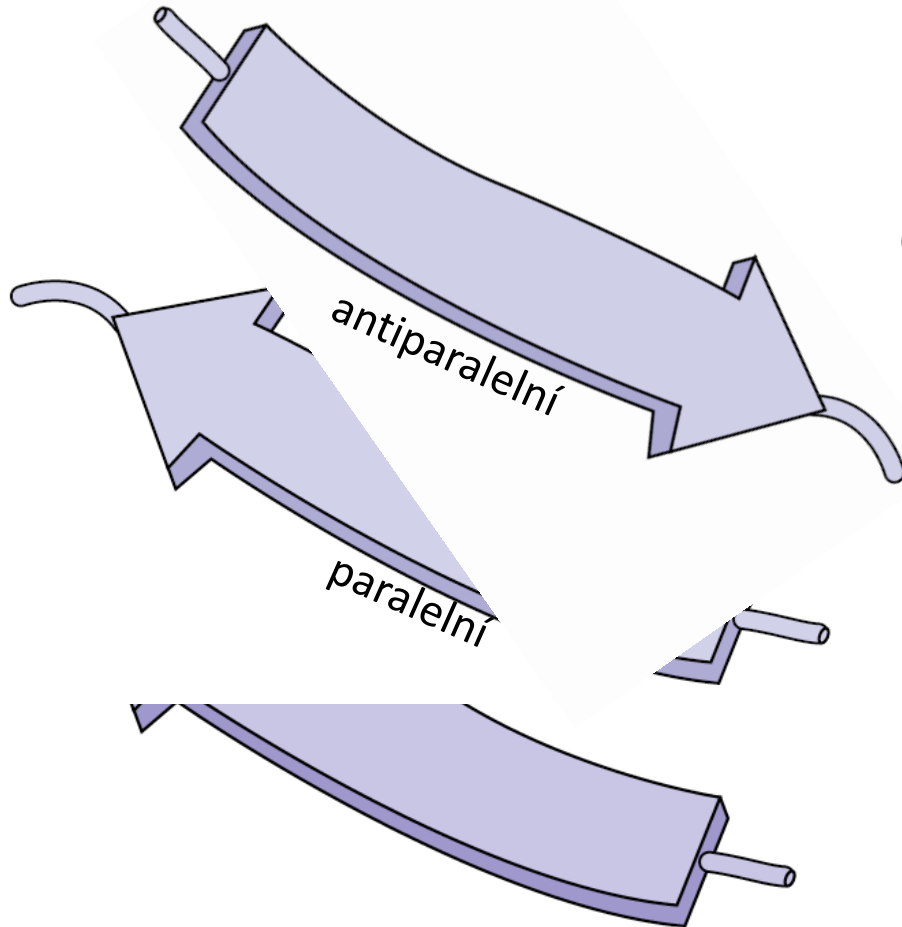

## antiparalelní uspořádání

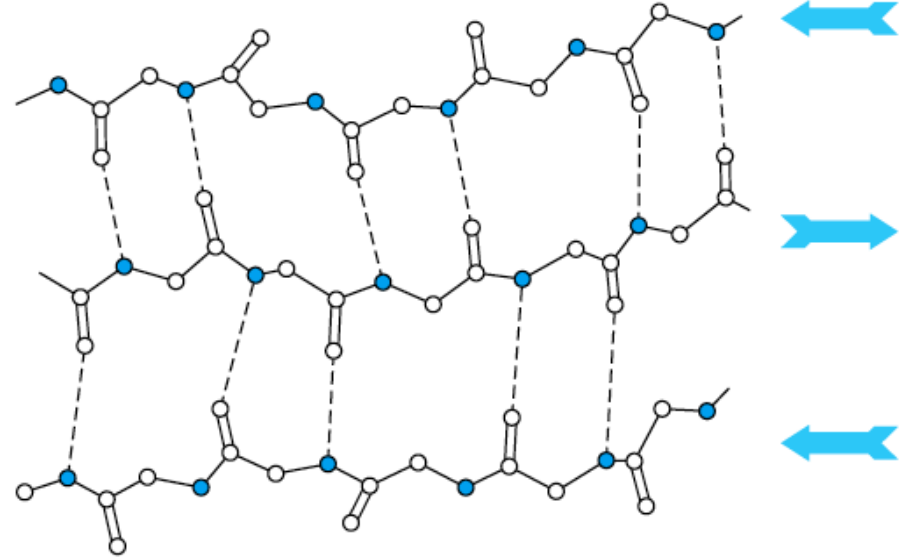

## paralelní uspořádání

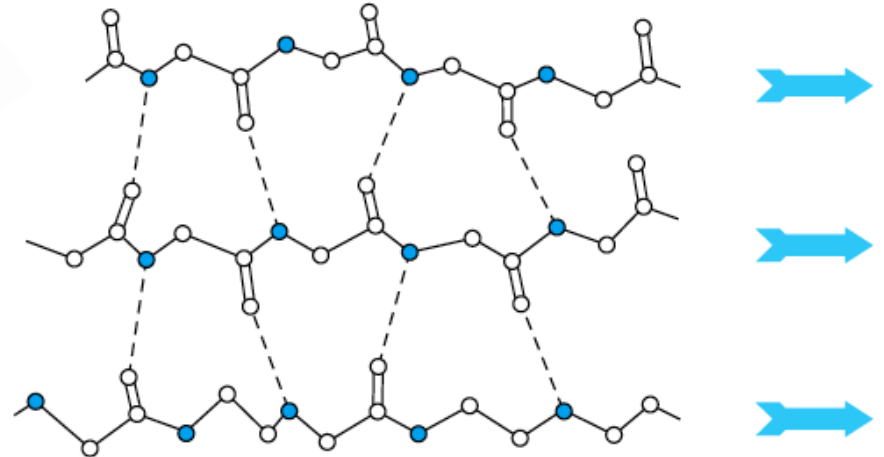

## VII] Sekundární struktura

1)  $\alpha$ -šroubovice ( $\alpha$ -helix)

2)  $\beta$ -skládání list ( $\beta$ -sheet)

### 3) Ohyb, smyčka (loop/turn)

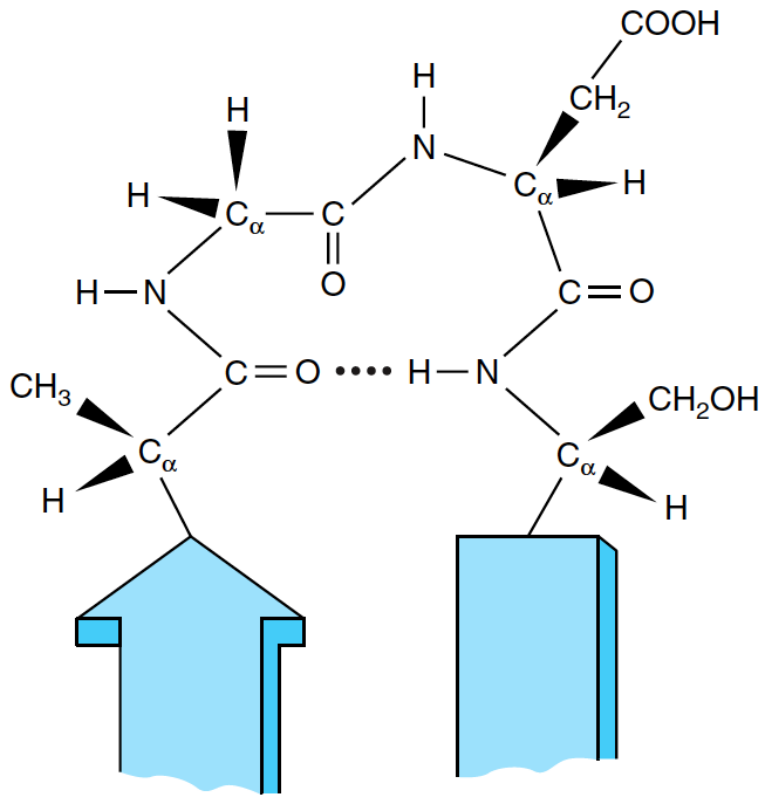

$\gamma$ -smyčka/ohyb (3 residua)

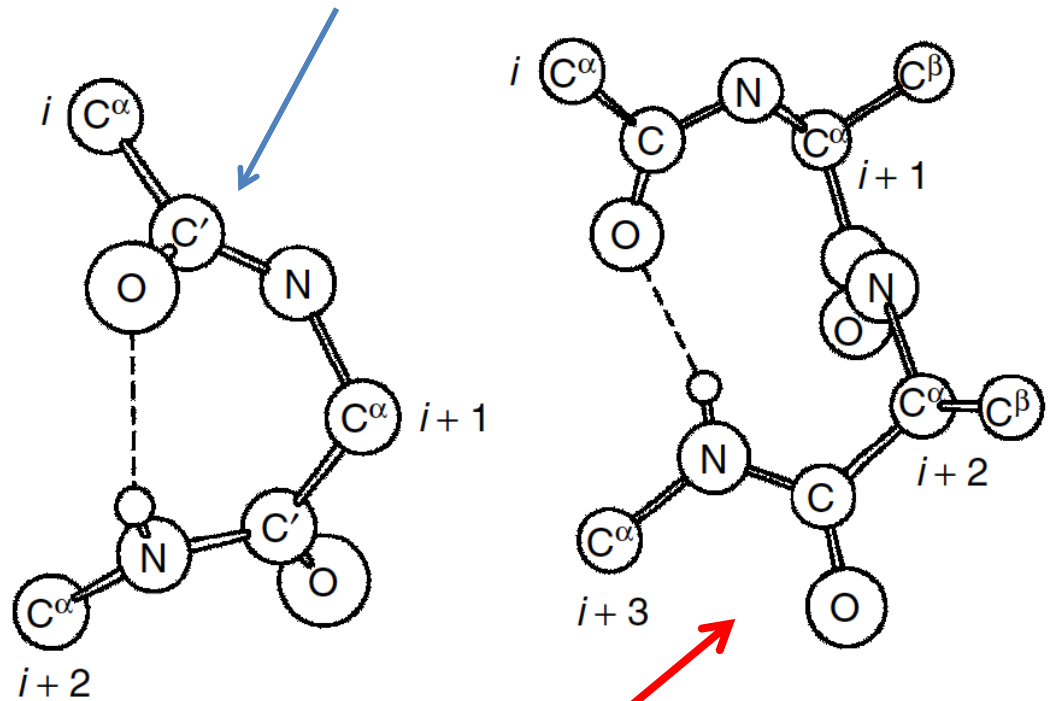

$\beta$ -smyčka/ohyb (4 residua)

# Ostatní motivy sekundární struktury :

1. polyprolinová šroubovice I & II – levotočivá, 3.3 nebo 3 (PPI, PPII, v uvedeném pořadí) aminokyseliny/otočku
2. šroubovice  $3_{10}$  (srovnej s  $3.6_{13}$ ) – pravotočivá, 3 aminokyseliny/otáčku, 10 atomů vytváří kruh uzavřený vodíkovou vazbou, např. poly-Ala
3.  $\pi$ -šroubovice – pravotočivá, 4.1 aminokyseliny/otáčku
4.  $\beta$ -šroubovice – vzniká uspořádáním  $\beta$ -skládaných listů do pravo- i levotočivé šroubovice.

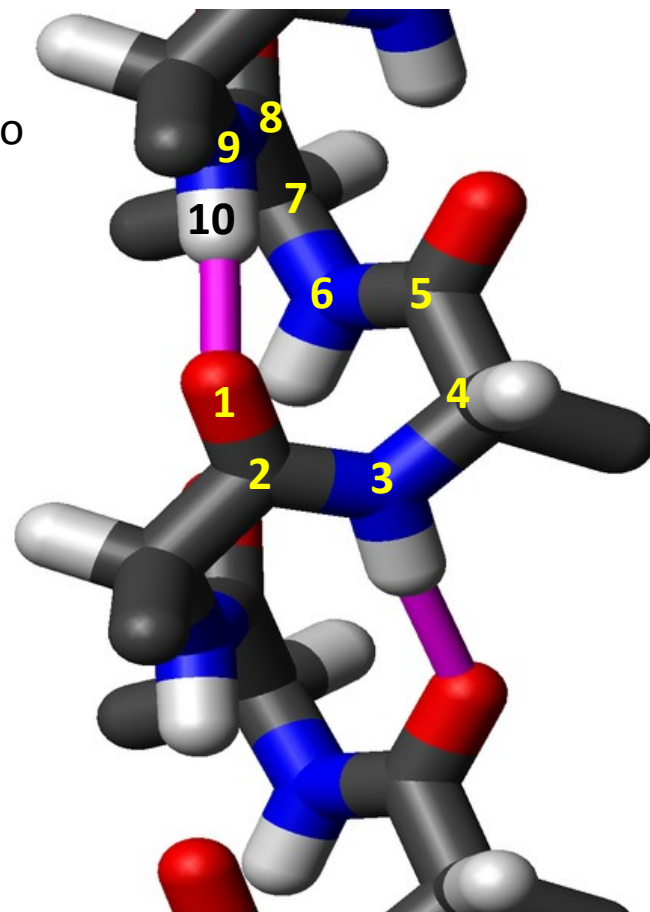



# Primary sequence reveals important clues about a protein

***One sequence keeps silent about its three-dimensional structure***

***Two aligned sequences whisper***

***But tables of many aligned sequences shout out loud***

# Primary sequence reveals important clues about a protein

- Evolution conserves amino acids that are important to protein structure and function across species. Sequence comparison of multiple “homologs” of a particular protein reveals highly conserved regions that are important for function.
- Clusters of conserved residues are called “motifs” -- motifs carry out a particular function or form a particular structure that is important for the conserved protein.

- small hydrophobic
- large hydrophobic
- polar
- positive charge
- negative charge

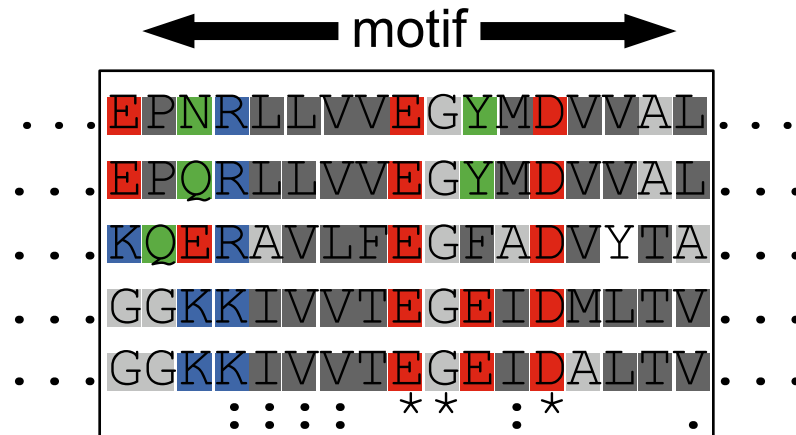

# Some motifs in protein sequences

Structure of function identified	Motif
Nucleotide-binding site	<b>G*G**G</b>
N-glycosylation site	<b>N*S</b> or <b>N*T</b>
Nuclear protein transit sequence	<b>KKRKRK</b>
Factor IX proteinase cleavage site	<b>IEGR</b>
Serine proteinase active site	<b>GDSGG</b>
Acid proteinase active site	<b>FDTGS</b>
Fibronectin cell adhesion sequence	<b>RGDS</b>
Copper binding site	<b>H***H...H</b> or <b>H****H...H</b>

\* = any single amino acid (AA)

\*\*\* = several AAs

... = any number of AAs

# Charged and polar R-groups tend to map to protein surfaces

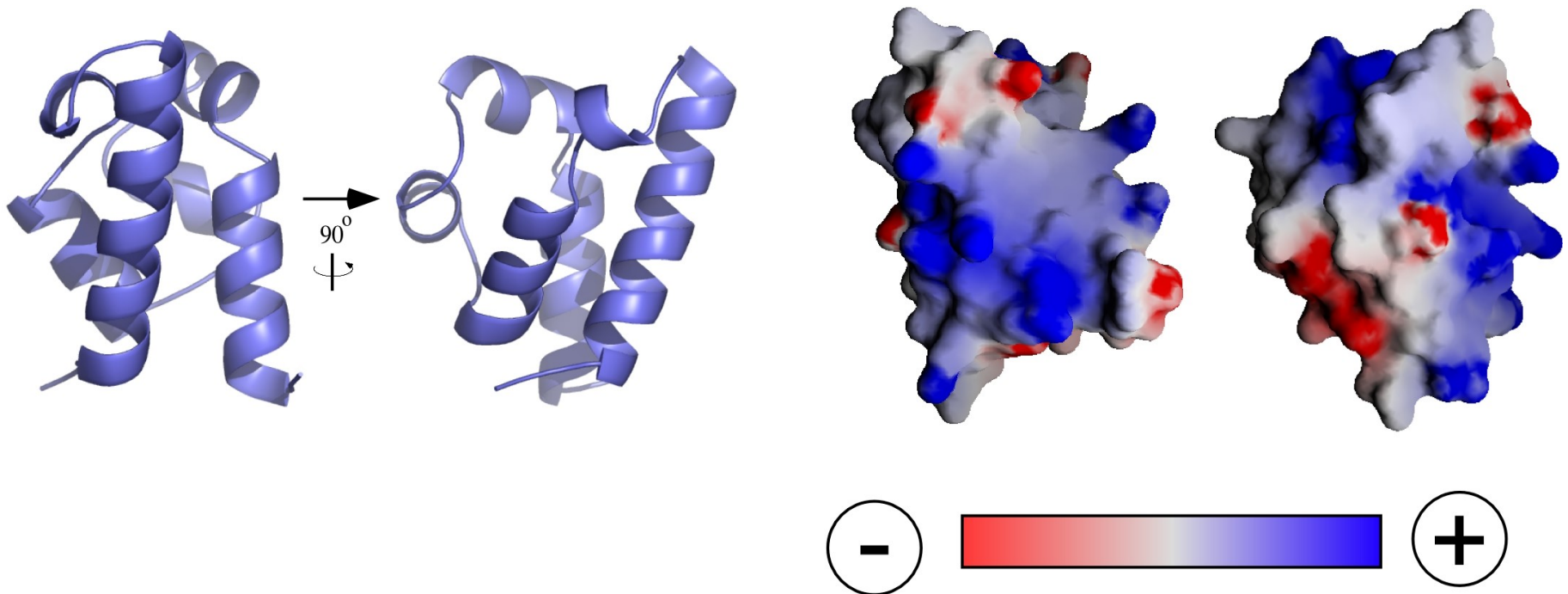

# Protein folding

The **Levinthal paradox** states that if an averaged sized protein would sample all possible conformations before finding the one with the lowest energy, the whole **process would take billions of years.**

Proteins **typically** fold within **0.1 and 1000 seconds**, therefore the protein folding process must be directed some way through a specific folding pathway.

# Protein folding

**Anfinsen's Classic Experiment:** The "Protein Folding Problem" asks a very simple question:

**"How does the primary structure of a protein determine its 2<sup>-</sup> and 3<sup>-</sup> structure?"**

We have known for many decades that proteins fold into their correct 3-D structures inside the cell. But correct folding during synthesis on the ribosome or later with assistance from unknown cellular factors could explain the *in vivo* results.

In the 1960's, Anfinsen and his coworkers performed a series of seminal experiments *in vitro* that answered a key part of the problem. The original work led Anfinsen to propose his "Thermodynamic Hypothesis", which states that the native conformation of a protein is adopted spontaneously. In other words, there is sufficient information contained in the protein sequence to guarantee correct folding from any of a large number of unfolded states. A schematic diagram of Anfinsen's experiment is shown below in two parts:

*Proceedings of the*  
NATIONAL ACADEMY OF SCIENCES

---

*Volume 47 · Number 9 · September 15, 1961*

THE KINETICS OF FORMATION OF NATIVE RIBONUCLEASE  
DURING OXIDATION OF THE REDUCED POLYPEPTIDE CHAIN

BY C. B. ANFINSEN, E. HABER,\* M. SELA,† AND F. H. WHITE, JR.

LABORATORY OF CELLULAR PHYSIOLOGY AND METABOLISM, NATIONAL HEART INSTITUTE,  
NATIONAL INSTITUTES OF HEALTH

*Communicated by John T. Edsall, July 31, 1961*

Bovine pancreatic ribonuclease is completely reduced by treatment with mercaptoethanol in 8 *M* urea to yield a randomly coiled polypeptide chain containing eight cysteine residues.<sup>1-3</sup> Under optimal conditions of polypeptide concentration and pH, essentially complete reformation of the disulfide bonds of the native enzyme occurs in the presence of molecular oxygen.<sup>2, 3</sup> From chemical and physical studies of the reformed enzyme, it may be concluded that the information for the correct pairing of half-cystine residues in disulfide linkage, and for the assumption of the native secondary and tertiary structures, is contained in the amino acid sequence itself.

---

## The Observation:

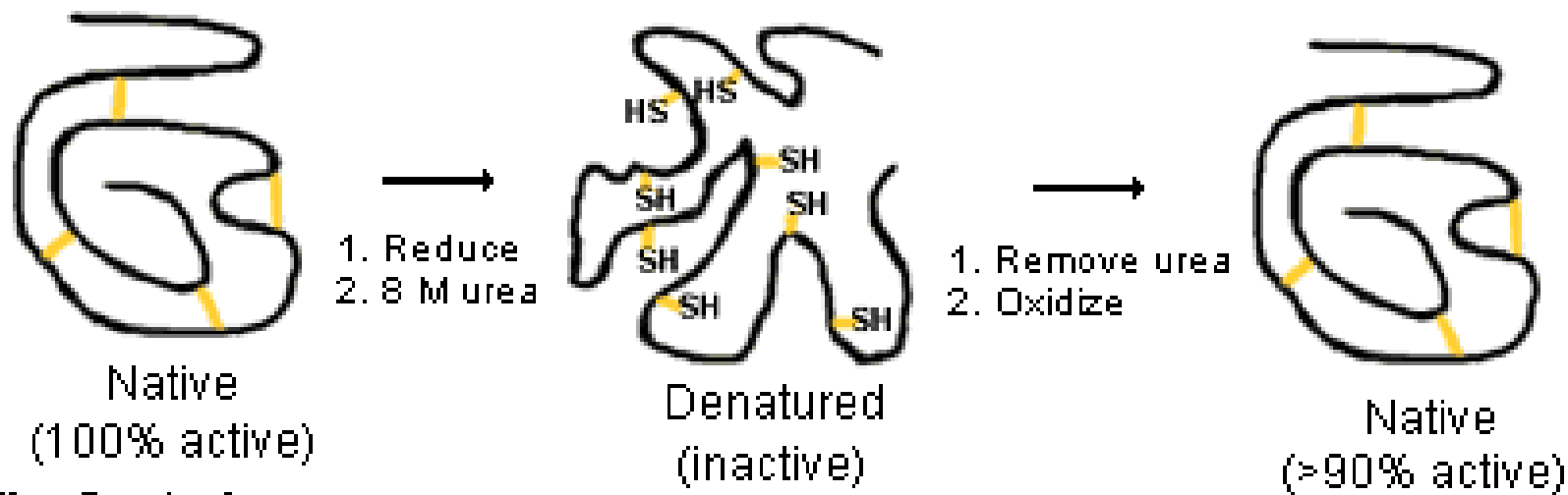

## The Control:

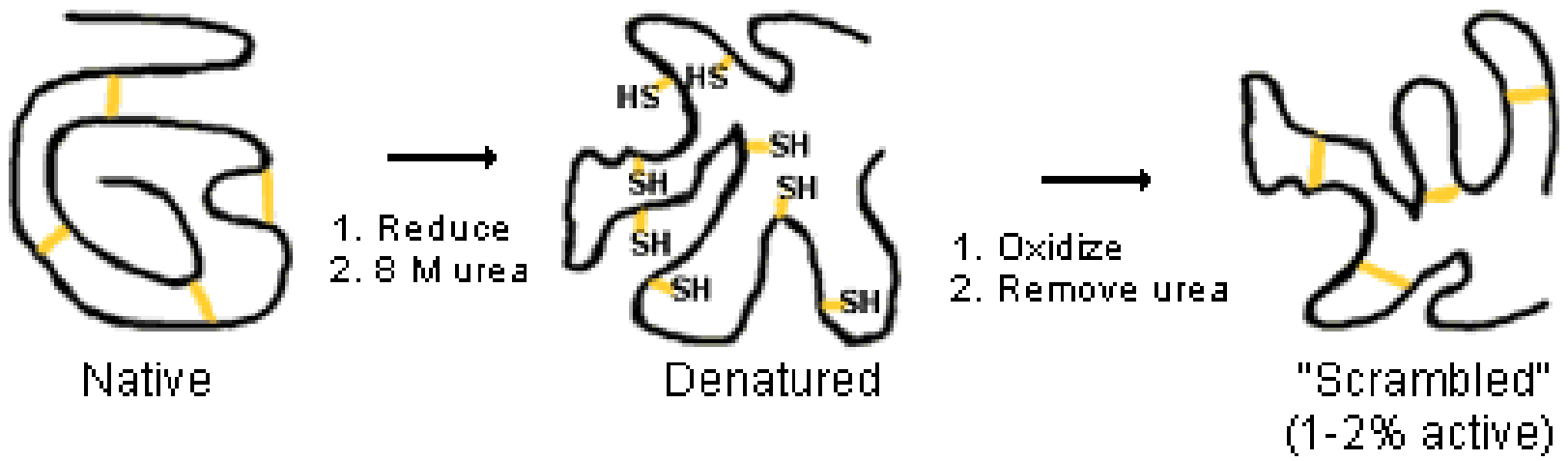



# VII] Terciární struktura proteinů

## 1) Kolagen

Primární struktura: — Gly — X — Y — Gly — X — Y — Gly — X — Y —

Sekundární struktura:



Terciární struktura:

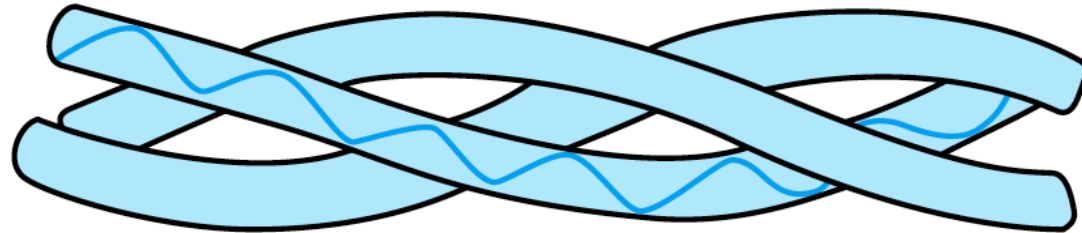

## 2) Disulfidický můstek: 2-SH (z cysteinu) → -S-S-

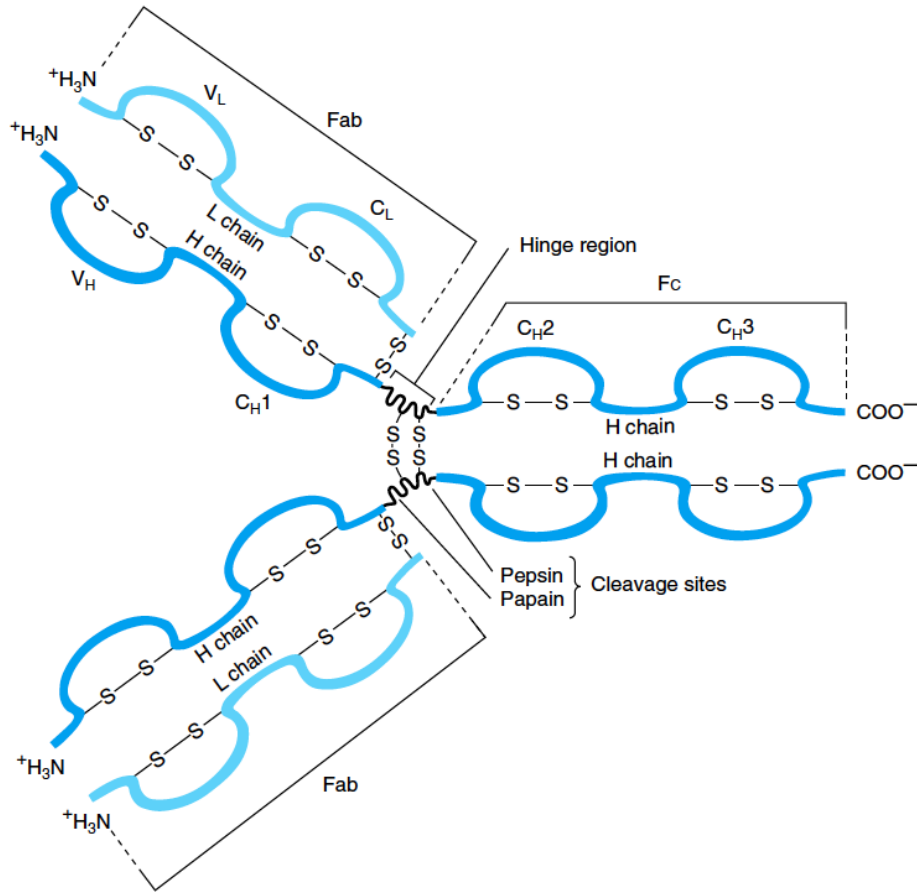

Disulfidické můstky v imunoglobulinu G

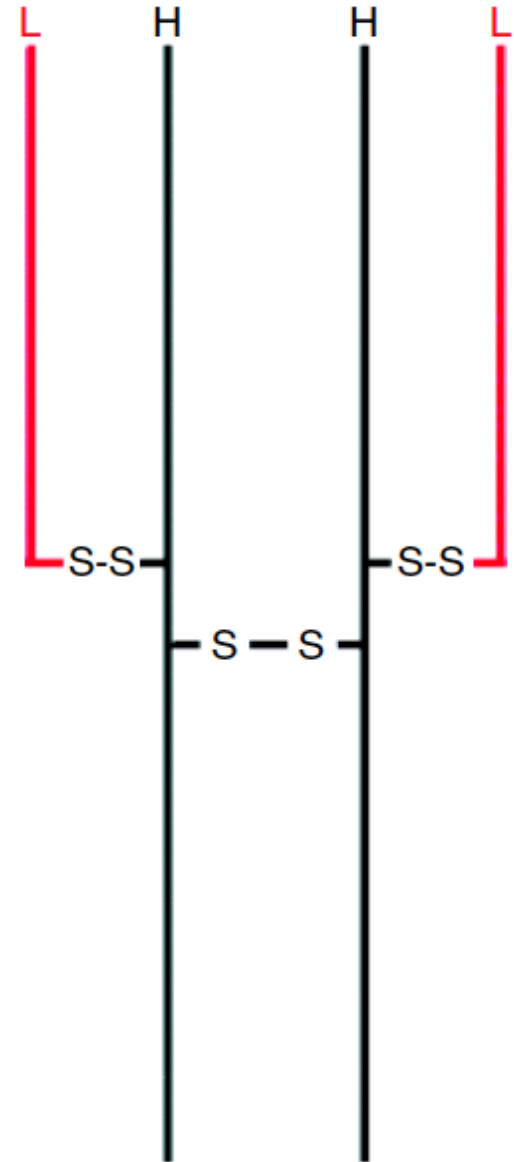

### 3) Strukturní motivy v proteinech

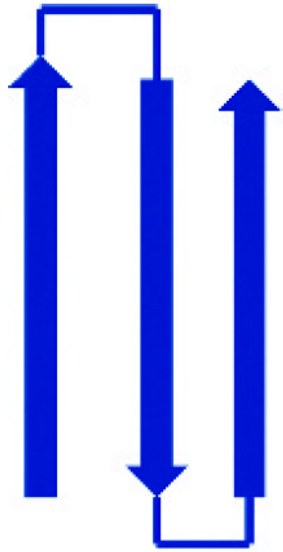

$\beta$ -meandr

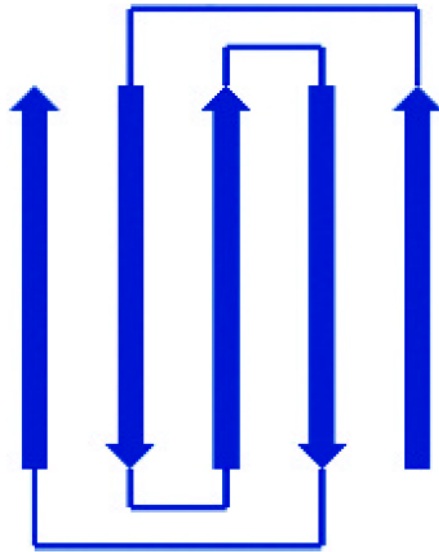

Řecký klíč

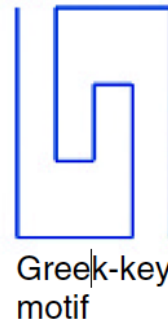

Greek-key  
motif

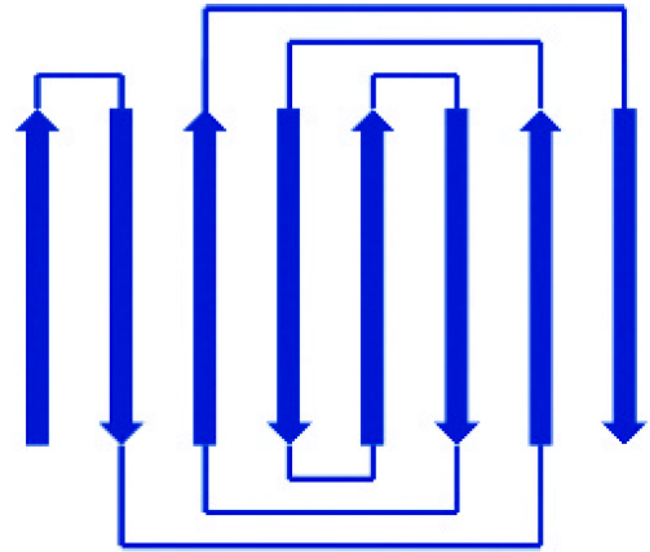

Swiss/Jelly roll



$\lambda$  repressor

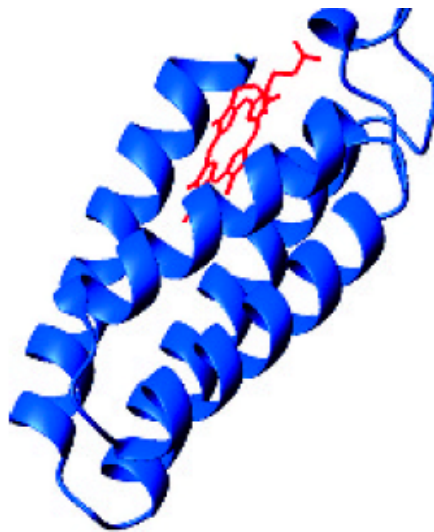

Cytochrome  $b_{562}$

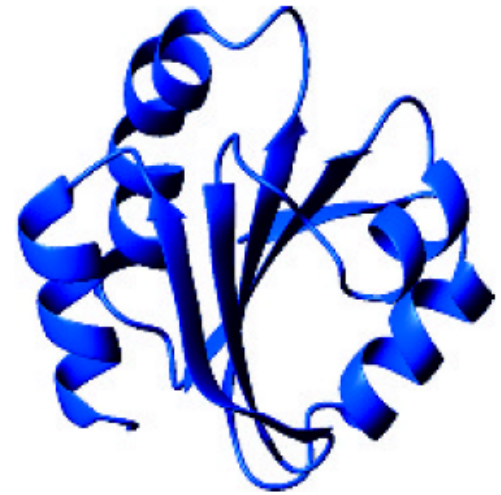

Thioredoxin



Plastocyanin

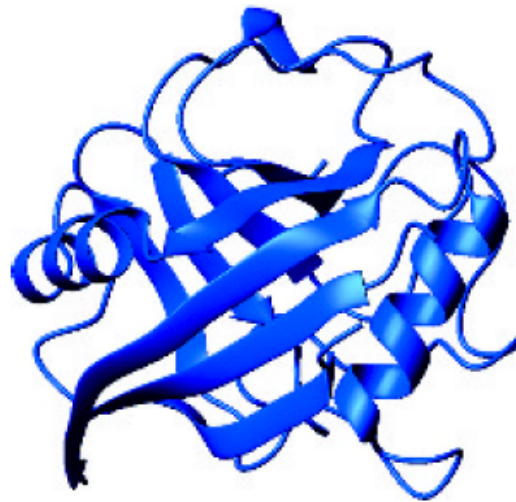

*cis-trans* proline isomerase



$\gamma$ -crystallin

## VIII] Kvartérní struktura proteinů

- 1) **Multimery**
- 2) **Homo-/hetero-  
-mery**

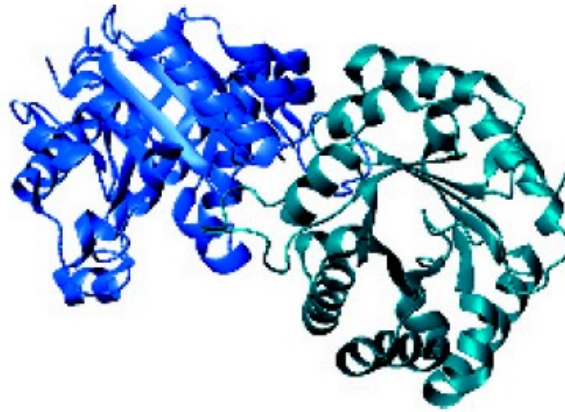

Triose phosphate isomerase (TIM)

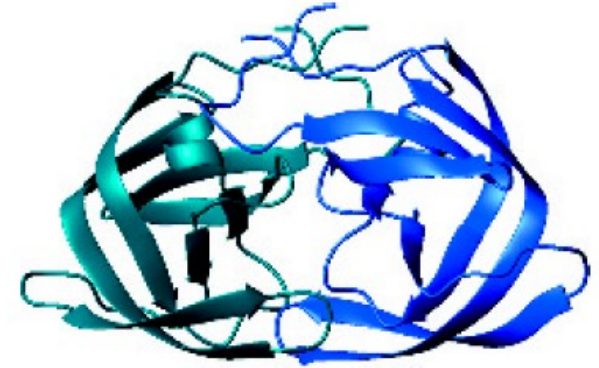

HIV protease

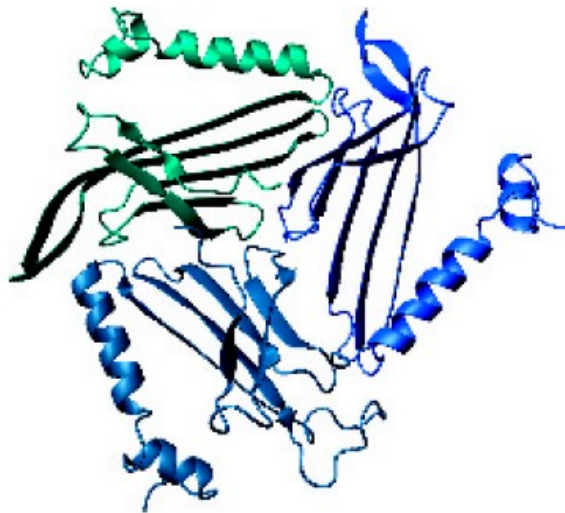

MS2 viral capsid protein



Haemoglobin

# Examples of other quaternary structures

Tetramer

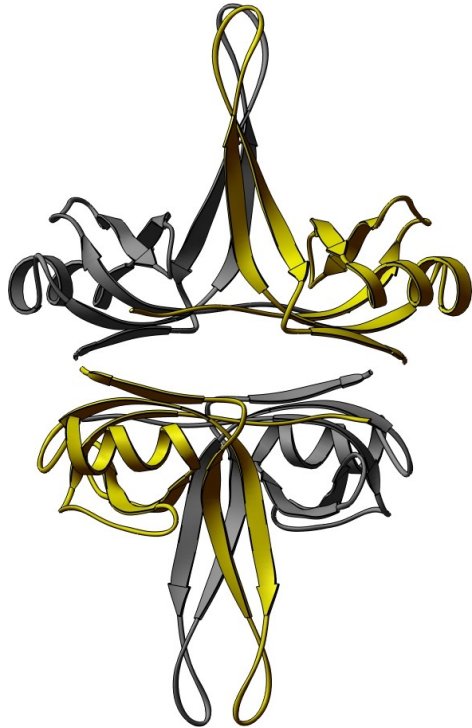

SSB

Allows coordinated DNA binding

Autumn Semester 2022

Hexamer

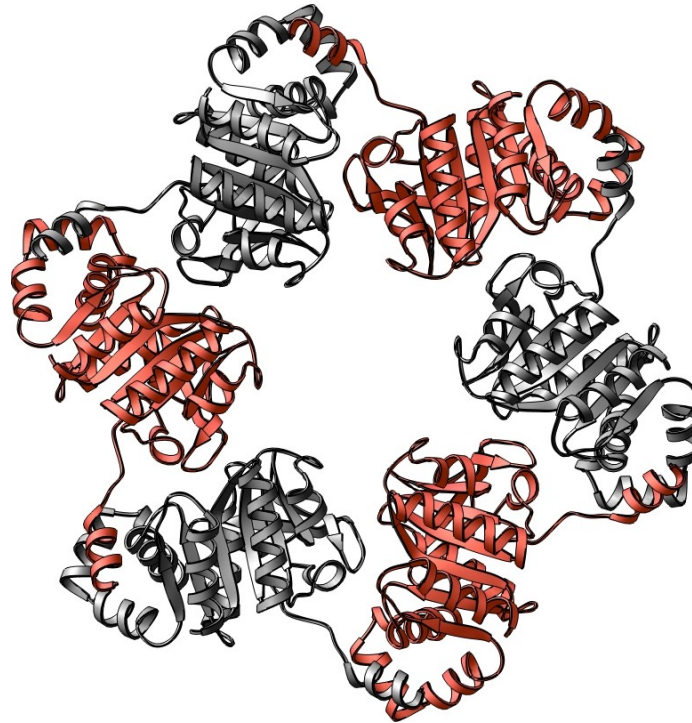

DNA helicase

Allows coordinated DNA binding and ATP hydrolysis

Proteins, Karel Kubíček

Filament

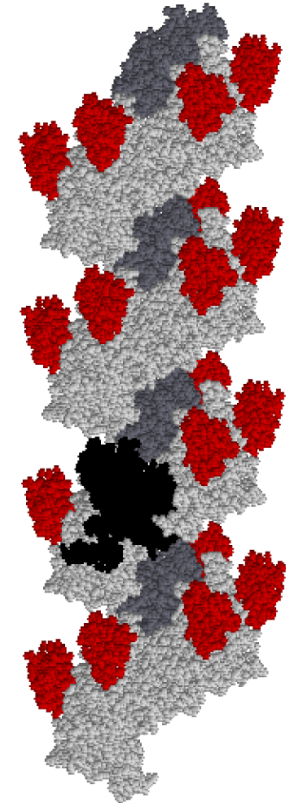

Recombinase

Allows complete coverage of an extended molecule

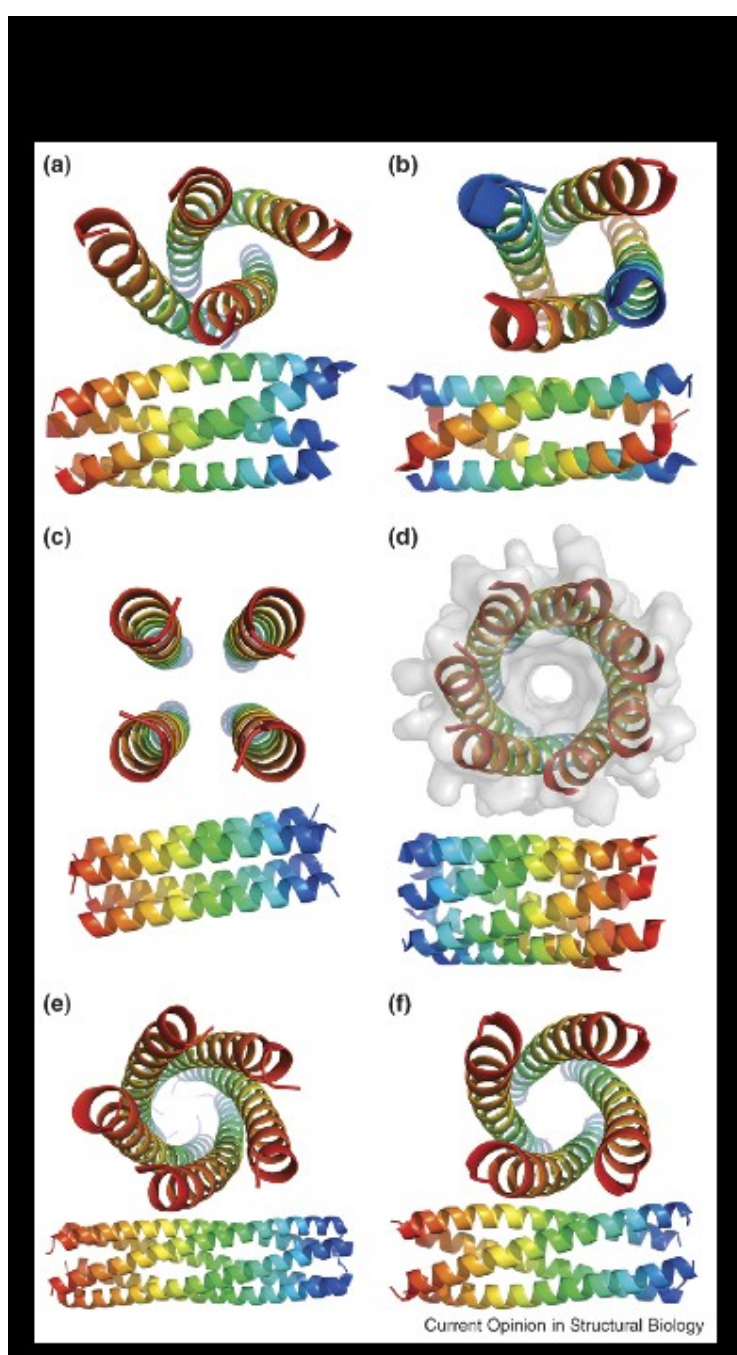

# Coiled coils

- bundle of  $\alpha$ -helices
- usually 2,3,4 helices
- parallel or antiparallel
- oligomers: homo- or hetero-

- 3.5 amino acids / turn
- 7 amino acid register
- inner residues - **hydrophobic**
- outer residues - **hydrophilic**

## - **knobs-into-holes:**

a residue from one helix (**knob**) packs into a space surrounded by **4** side-chains of the facing helix (**hole**)

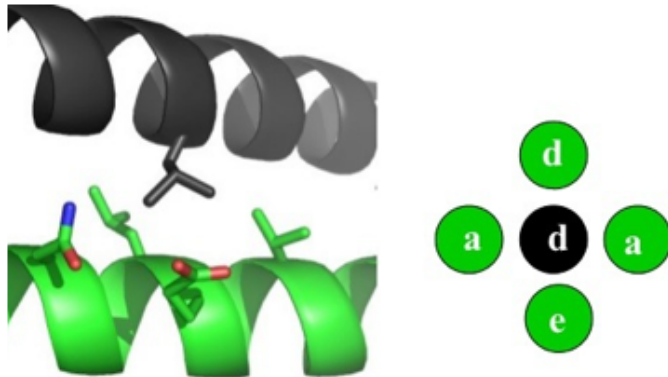

**[abcdefg]<sub>n</sub>**

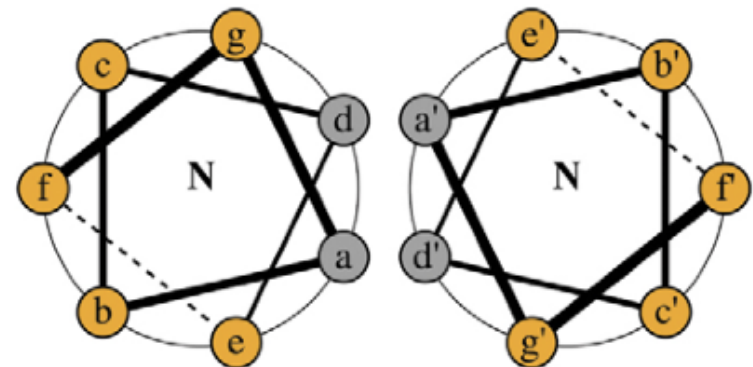

Lupas, A.N., and Gruber, M. (2005).  
The Structure of  $\alpha$ -Helical Coiled Coils.



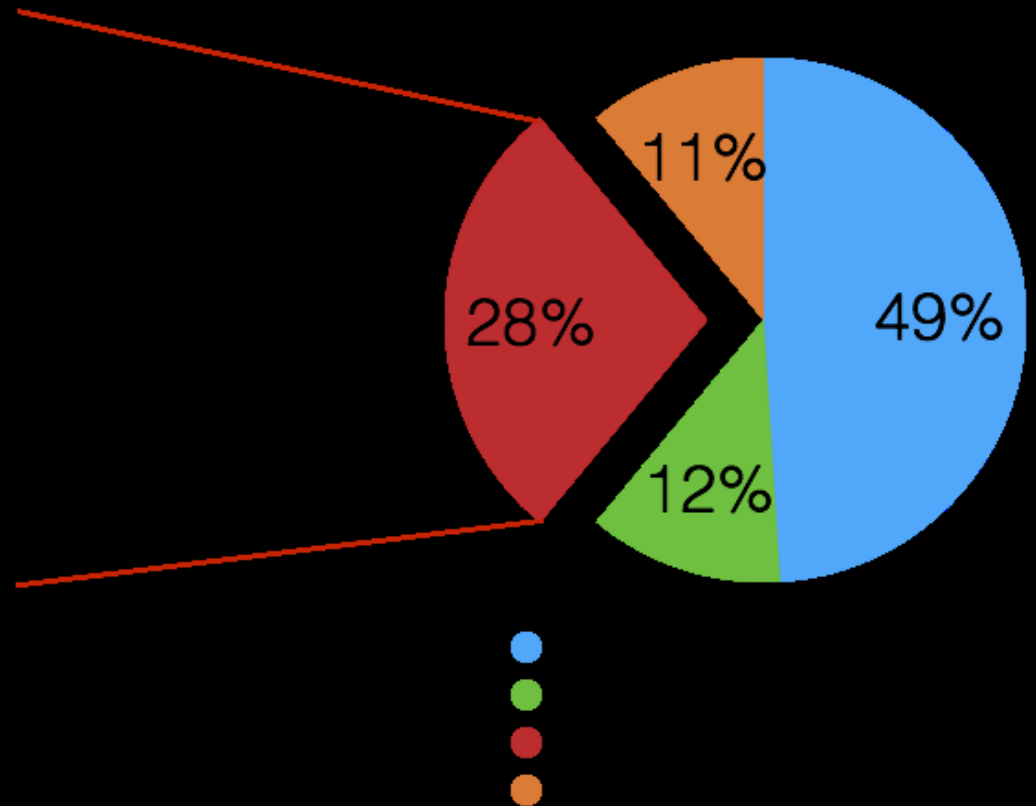

Barbara, et al 2007

Coiled coil structures and transcription: an analysis of the *S. cerevisiae* coilome.

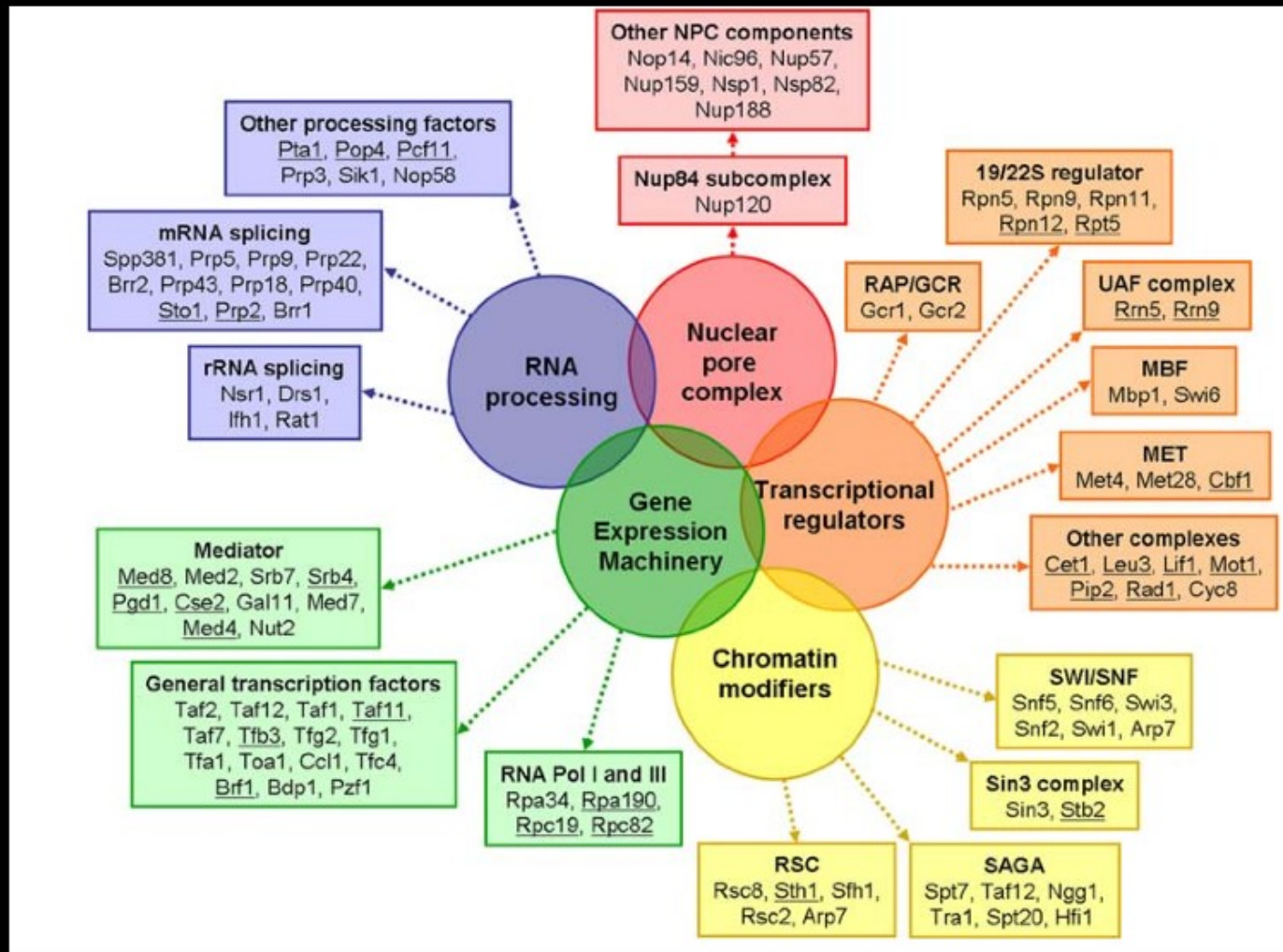

Barbara, et al 2007  
 Coiled coil structures and transcription: an analysis of the *S. cerevisiae* coilome.

# Useful software

- **COILS** (prediction of coiled coil regions)  
[http://embnet.vital-it.ch/software/COILS\\_form.html](http://embnet.vital-it.ch/software/COILS_form.html)
- **MARCOIL** (prediction of coiled coil regions)  
<http://bcf.isb-sib.ch/webmarcoil/webmarcoilINFOC1.html>
- **MULTICOIL** (prediction of coiled coil regions, oligomeric state)
- **LOGICOIL** (oligomeric state probabilities)  
<http://coiledcoils.chm.bris.ac.uk/LOGICOIL/>
- **DrawCoil 1.0** (heptade diagrams)  
<http://www.grigoryanlab.org/drawcoil/>
- **CCBuilder** (building CC from the sequence)  
[http://coiledcoils.chm.bris.ac.uk/app/cc\\_builder/](http://coiledcoils.chm.bris.ac.uk/app/cc_builder/)
- **SOCKET** (locate knobs-into-holes packing between alpha-helices in PDB structures)  
<http://coiledcoils.chm.bris.ac.uk/socket/index.html>
- **CCCP** (Coiled-coil Crick Parameterization)  
<http://www.grigoryanlab.org/cccp/>

# Confidence in structural features of proteins determined by X-ray crystallography

(estimates are very rough and strongly depend on the quality of the data)

Structural feature			Resolution		
	5 Å	3 Å	2.5 Å	2 Å	1.5 Å
Chain tracing	-	Fair	Good	Good	Good
Secondary structure	Helices fair	Fair	Good	Good	Good
Sidechain conformations	-	-	Fair	Good	Good
Orientation of peptide planes	-	-	Fair	Good	Good
Protein hydrogen atoms visible	-	-	-	-	Good

## **XII] Metody pro určování třídímenzionální struktury (bio)molekul na atomární úrovni**

- 1) NMR – nukleární (=jaderná) magnetická rezonance – měření (také) v kapalném prostředí**
- 2) Rentgenová krystalografie - (měření především v krystalu)**
- 3) Kryo-elektronová mikroskopie**

# THE PROTEIN TRINITY

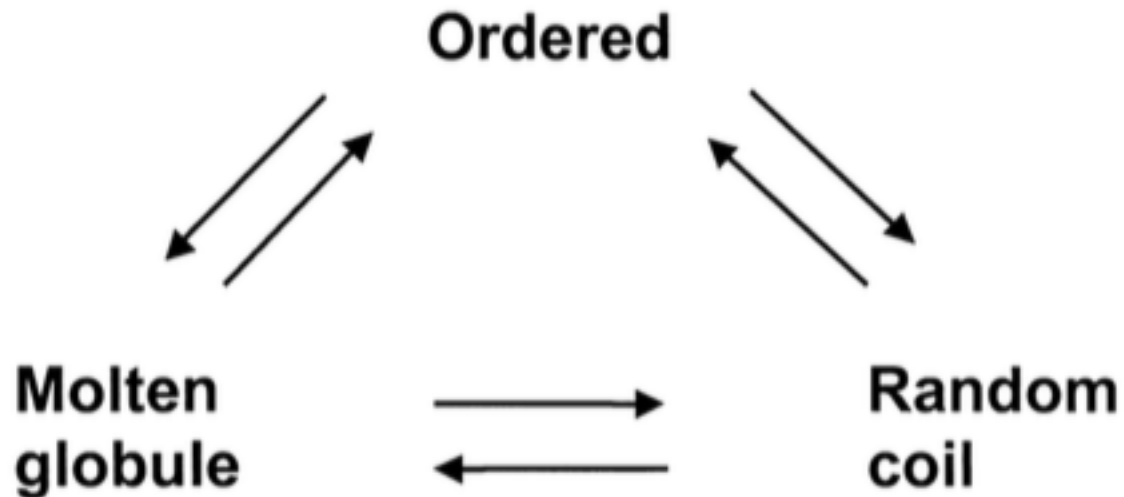

**Proposal: Function can arise from any of the three protein forms and transitions between them.**

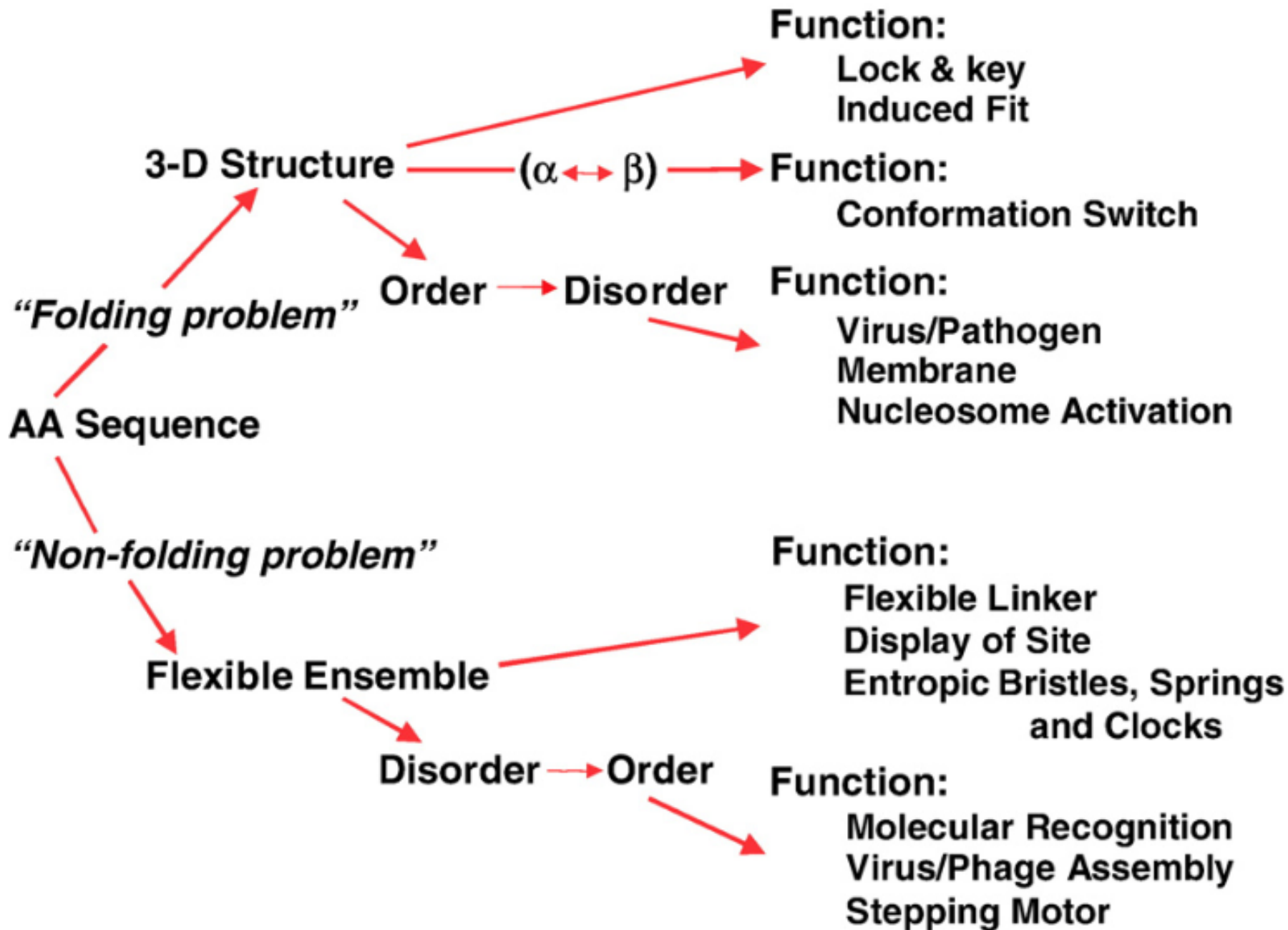

## IX] Funkce proteinů:

- 1) Enzymy – katalyzátory biologických reakcí
- 2) Transportní proteiny (hemoglobin)
- 3) Regulační proteiny (např. hormon insulin)
- 4) Skladovací (storage) – např. ovalbumin – zdroj dusíku pro vyvíjející se ptačí embryo
- 5) “Pohybové” proteiny – actin, myosin, tubulin, dynein, kinesin
- 6) Strukturní proteiny – zajišťující vytvoření a udržení biologické struktury –  $\alpha$ -keratin, kolagen, elastin, fibroin etc.
- 7) Ochranné – imunoglobuliny, fibrinogen, thrombin



## X] Proteinová databáze – PDB

[WWW.RCSB.ORG](http://WWW.RCSB.ORG)

## XI] Vizualizační programy

- 1) PyMol
- 2) Chimera
- 3) VMD
- 4) MolMol
- 5) RasMol
- 6) Insight II