

Bi9393 Analytical cytometry

Lesson 2



Karel Souček, Ph.D.

Department of Cytokinetics
Institute of Biophysics, CAS,
v.v.i.
Kralopolska 135
612 65 Brno

E-mail: ksoucek@ibp.cz
tel.: 541 517 166

The NK cell receptor NKp46 recognizes ecto-calreticulin on ER-stressed cells

<https://doi.org/10.1038/s41586-023-05912-0>

Received: 13 August 2020

Accepted: 2 March 2023

Published online: 5 April 2023

 Check for updates

Sumit Sen Santara^{1,2,3,9}, Dian-Jang Lee^{1,2,9}, Ângela Crespo^{1,2}, Jun Jacob Hu^{1,4}, Caitlin Walker^{1,4}, Xiyu Ma^{1,2}, Ying Zhang^{1,2}, Sourav Chowdhury⁵, Karla F. Meza-Sosa^{1,2,6}, Mercedes Lewandrowski^{1,2}, Haiwei Zhang^{1,2}, Marjorie Rowe^{1,2}, Arthur McClelland⁷, Hao Wu^{1,4}, Caroline Junqueira^{1,2,8} & Judy Lieberman^{1,2}✉

Natural killer (NK) cells kill infected, transformed and stressed cells when an activating NK cell receptor is triggered¹. Most NK cells and some innate lymphoid cells express the activating receptor NKp46, encoded by *NCRI*, the most evolutionarily ancient NK cell receptor^{2,3}. Blockage of NKp46 inhibits NK killing of many cancer targets⁴. Although a few infectious NKp46 ligands have been identified, the endogenous NKp46 cell surface ligand is unknown. Here we show that NKp46 recognizes externalized calreticulin (ecto-CRT), which translocates from the endoplasmic reticulum (ER) to the cell membrane during ER stress. ER stress and ecto-CRT are hallmarks of chemotherapy-induced immunogenic cell death^{5,6}, flavivirus infection and senescence. NKp46 recognition of the P domain of ecto-CRT triggers NK cell signalling and NKp46 caps with ecto-CRT in NK immune synapses. NKp46-mediated killing is inhibited by knockout or knockdown of *CALR*, the gene encoding CRT, or CRT antibodies, and is enhanced by ectopic expression of glycosylphosphatidylinositol-anchored CRT. *NCRI*-deficient human (and *Ncr1*-deficient mouse) NK cells are impaired in the killing of ZIKV-infected, ER-stressed and senescent cells and ecto-CRT-expressing cancer cells. Importantly, NKp46 recognition of ecto-CRT controls mouse B16 melanoma and RAS-driven lung cancers and enhances tumour-infiltrating NK cell degranulation and cytokine secretion. Thus, NKp46 recognition of ecto-CRT as a danger-associated molecular pattern eliminates ER-stressed cells.

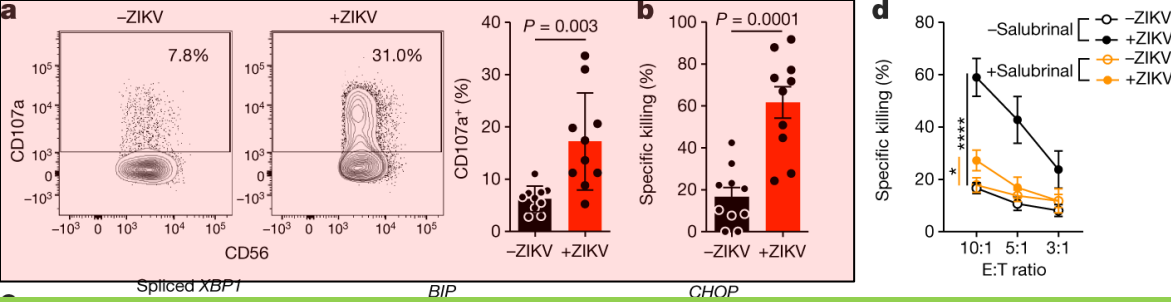

a, Representative flow cytometry plots (left) and percentage of degranulating NK cells isolated from the blood of ten healthy donors (right), as measured by surface CD107a, in response to uninfected and ZIKV-infected JEG-3 cells (8 h coculture, E:T ratio 1:3). **b**, NK cell-specific killing of uninfected and ZIKV-infected JEG-3 cells. **c**, ER stress, as assessed by *XBP1* splicing (left) and increases in *BIP* (middle) and *CHOP* (right) mRNA, in JEG-3 cells that were uninfected or infected with ZIKV, HSV-2 or human cytomegalovirus (HCMV) for 1–2 days or treated with tunicamycin (Tu) for 1 day. Indicated samples were pretreated with the ER stress inhibitor salubrinal ($n = 3$ samples). mRNA levels, as assayed by quantitative PCR with reverse transcription (RT-qPCR), were normalized to *ACTB*. **d**, Effect of salubrinal pretreatment of target cells on NK cell killing of ZIKV-infected (top) and tunicamycin-treated (bottom) JEG-3 cells ($n = 6$ samples). **e**, Effect of NKR-blocking antibodies (Ab) on NK cell killing of uninfected or ZIKV-infected JEG-3 cells ($n = 3–7$ samples). Ctrl, control. **f**, Specific killing of the classical NK cell target 722.221 cells, or of uninfected or ZIKV-infected JEG-3 cells by human NK cell line YT cells knocked out for *NCR1* or *NCR3* or treated with control single-guide RNAs ($n = 3–6$ samples). **g**, Representative flow cytometry histogram (left) and mean fluorescence intensity (MFI) of NKR-Ig fusion protein (Nkp46-Ig and NKG2D-Ig) binding to uninfected or ZIKV-infected JEG-3 cells (right) ($n = 3$ samples). **b,d–f**, Specific killing assessed by 8 h ^{51}Cr release assay using an E:T ratio of 10:1 unless otherwise indicated. Data are mean \pm s.e.m. of at least three independent experiments or technical replicates. Statistics were performed using two-tailed, nonparametric, unpaired *t*-test (**a,b**), one-way analysis of variance (ANOVA) (**c**), two-way ANOVA (**e–g**) or area under the curve followed by one-way ANOVA (**d**). * $P < 0.05$, ** $P < 0.01$, *** $P < 0.001$, **** $P < 0.0001$.

-CD56 is a single transmembrane glycoprotein also known as N-CAM (Neural Cell Adhesion Molecule), Leu-19, or NKH1. It is a member of the Ig superfamily. The 140 kD isoform is expressed on NK cells and NK-T cells. CD56 is also expressed in the brain (cerebellum and cortex) and at neuromuscular junctions.

-lysosomal-associated membrane protein-1 (LAMP-1 or CD107a) has been described as a marker of CD8+ T-cell degranulation following stimulation.

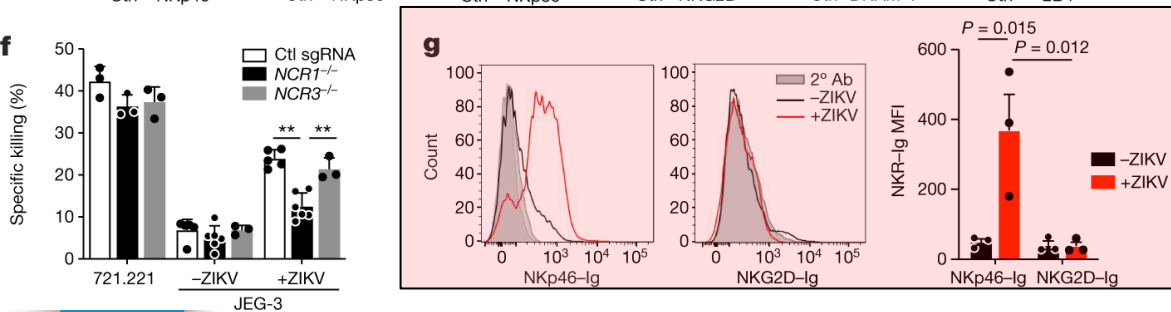

The NK cell receptor NKP46 recognizes ectocalreticulin on ER-stressed cells

Sumit Sen-Santara, Dian-Jiang Lee, Angela Crespo, Jun-Jacob Hu, Caitlin Walker, Xinyi Ma, Ying Zhang

Soumya Choudhury, Karla F. Mesa-Sosa, Mercedes Lewandrowski, Haiwei Zhang, Marjorie Rowe, Arthur

McClelland, Hao Wu, Caroline Junqueira  & Judy Lieberman Nature 616, 348–356 (2023) | [Cite this article](#)17k Accesses | 8 Citations | 99 Altmetric | [Metrics](#)

Flow cytometry

For surface staining, cells were stained for 30 min on ice in the dark with LIVE/DEAD-Violet stain (1:1,000) and then with primary antibodies for 15–30 min in PBS and 2% FCS (followed by secondary antibodies, when applicable, for 20 min). For protein–Ig staining, cells were incubated with 50 $\mu\text{g ml}^{-1}$ fusion protein for 1 h at 4 °C and then stained with fluorescent-anti-human IgG for 1 h. Cells were fixed in 1% paraformaldehyde (Affymetrix) for 10 min before flow cytometry. Flow cytometry was assessed on gated live cells (Supplementary Fig. [1](#)). For intracellular staining, cells were fixed and permeabilized using the CytoFix/CytoPerm kit. One of the treated samples was used for isotype staining, and MFI of staining with the isotype control antibody was subtracted from MFI of the specific antibody. Analysis was performed on a FACSCanto II (BD). BD FACSDiva 8.0 (BD) software was used for data collection, with analysis performed using FlowJo v.10.4.2 (TreeStar).

Supplementary Figure 1 | Flow cytometry gating strategy

a. Peripheral blood NK or YT NK cultured with JEG-3.

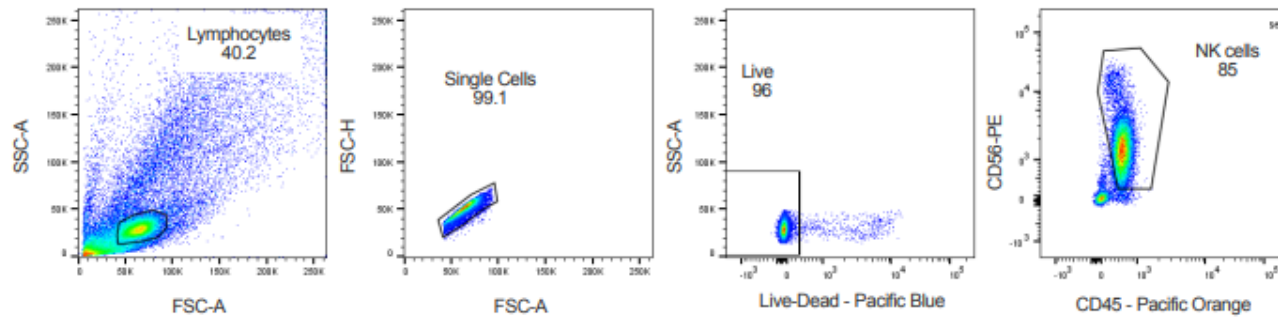

b. Tumor infiltrating lymphocytes (TILs) from tumor-bearing mice

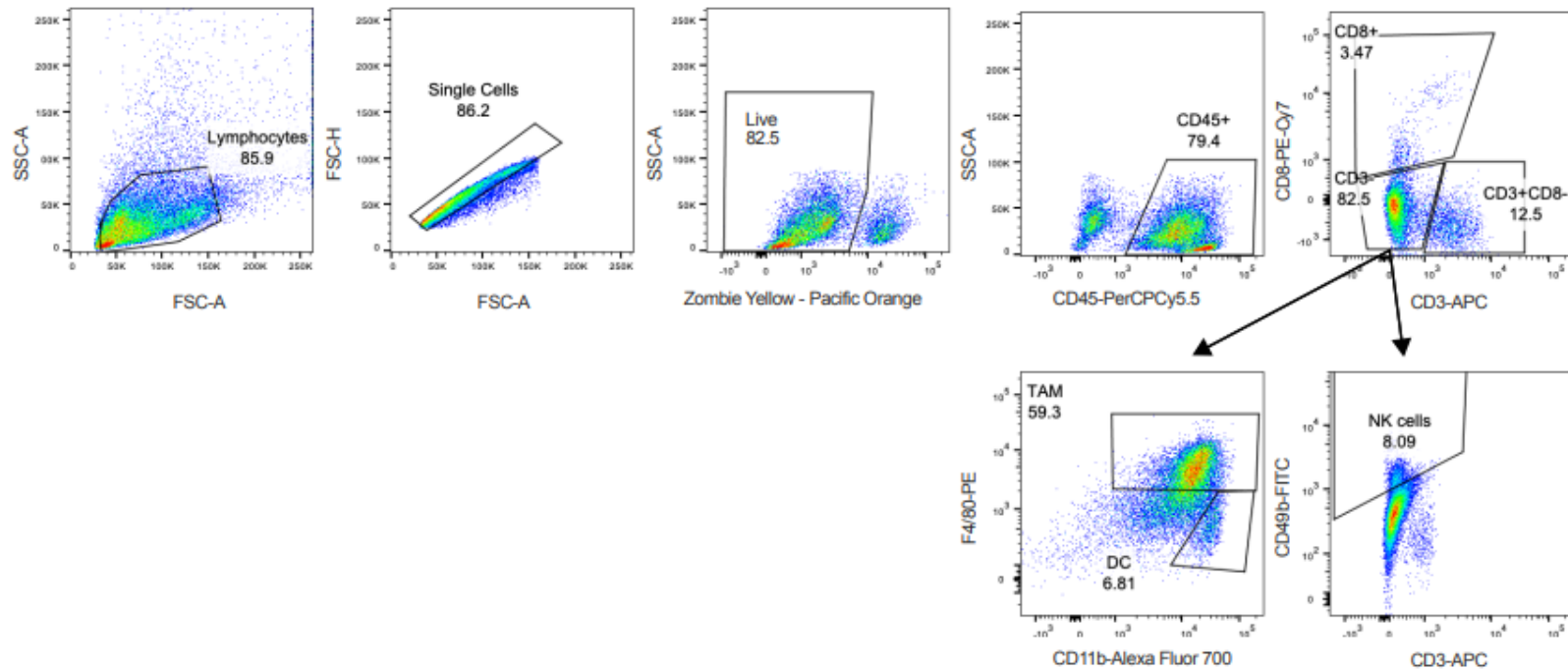

Comment



Replication games: how to make reproducibility research more systematic

Abel Brodeur, Anna Dreber, Fernando Hoces de la Guardia & Edward Miguel

In some areas of social science, around half of studies can't be replicated. A new test-fast, fail-fast initiative aims to show what research is hot – and what's not.

In October last year, one of us (A.B.) decided to run an ad hoc workshop at a research centre in Oslo, to try to replicate papers from economics journals. Instead of the handful of locals who were expected to attend, 70 people from across Europe signed up. The message was clear: researchers want to replicate studies.

Replication is sorely needed. In areas of the social sciences, such as economics, philosophy and psychology, some studies suggest that between 35% and 70% of published results cannot be replicated when tested with

new data¹⁻⁴. Often, researchers cannot even reproduce results when using the same data and code as the original paper, because key information is missing.

Yet most journals will not publish a replication unless it refutes an impactful paper. In economics, less than 1% of papers published in the top 50 journals between 2010 and 2020 were some type of replication⁵. That suggests that many studies with errors are going undetected.

After the Oslo workshop, we decided to try to make replication efforts in our fields of economics and political science more systematic.

Reproducibility of results

Nature 533, 452-454 (26 May 2016)
doi:10.1038/533452a

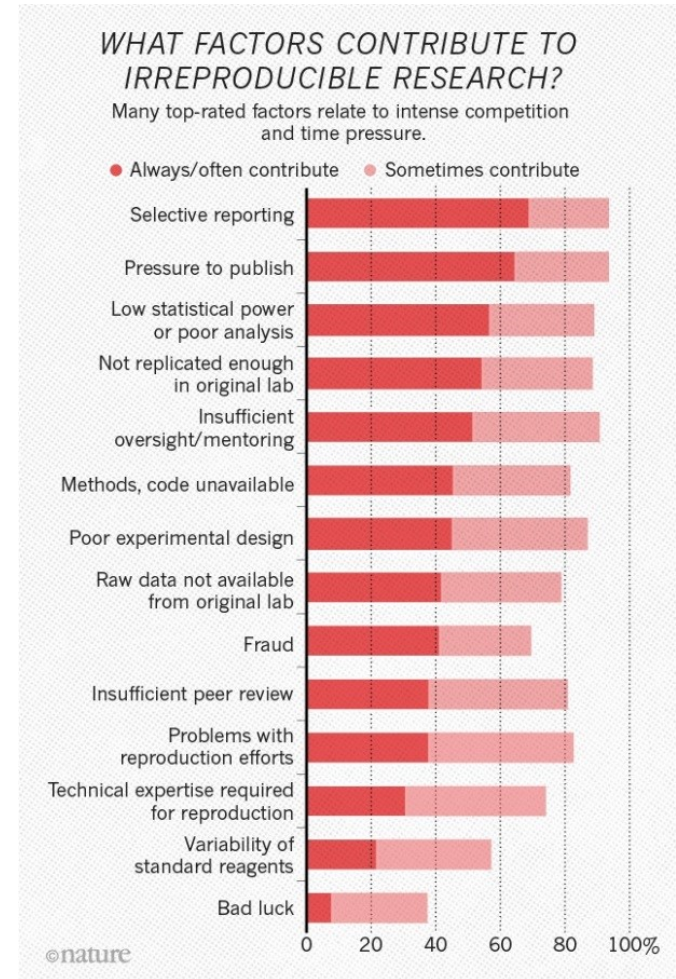
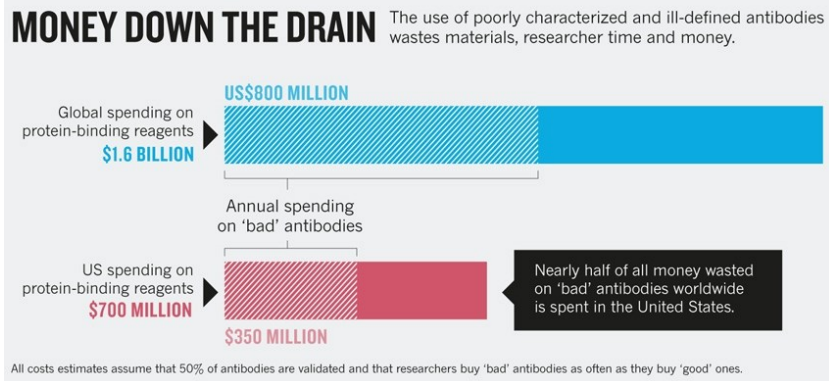
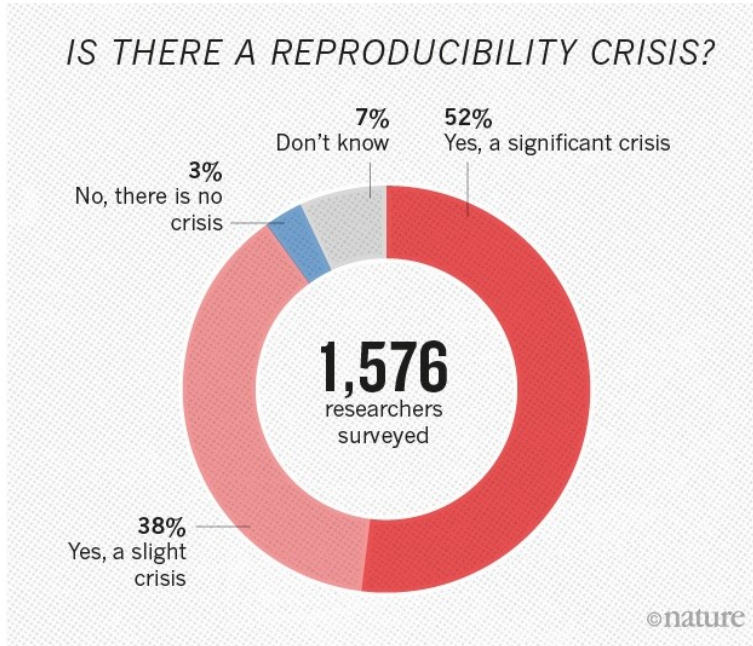

[Circ Res.](#) 2015 Jan 2;116(1):116-26. doi: 10.1161/CIRCRESAHA.114.303819.

Reproducibility in science: improving the standard for basic and preclinical research.

[Begley CG](#)¹, [Ioannidis JP](#)².

[Nature.](#) 2015 Feb 5;518(7537):27-9. doi: 10.1038/518027a.

Reproducibility: standardize antibodies used in research.

[Bradbury A](#)¹, [Plückthun A](#)².

WHAT FACTORS COULD BOOST REPRODUCIBILITY?

Respondents were positive about most proposed improvements but emphasized training in particular.

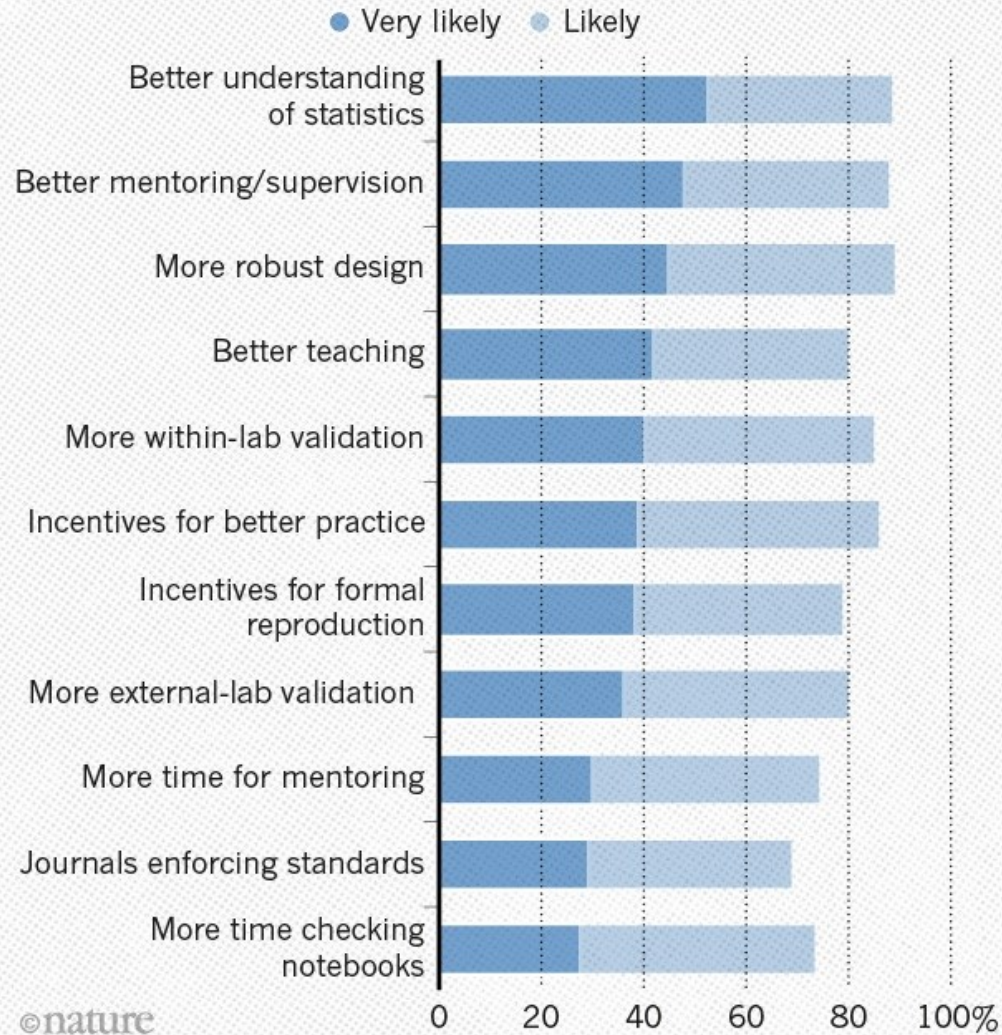

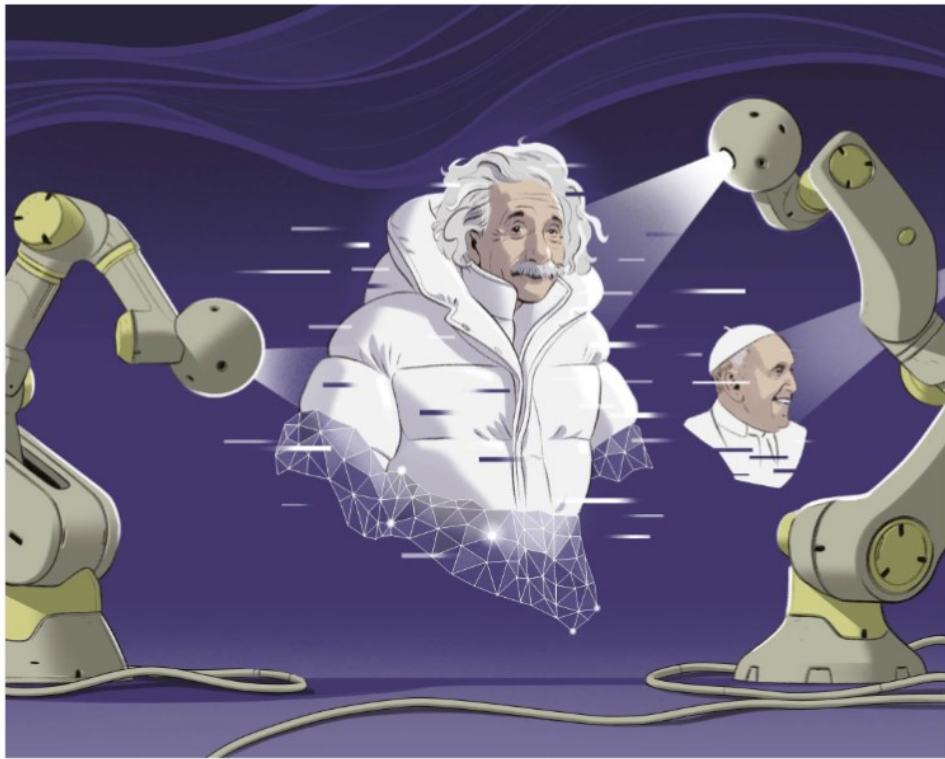

ILLUSTRATION BY STEVE HAHNE

HOW TO STOP DEEPFAKES FROM SINKING THE INTERNET

Deceptive videos and images created using generative AI could sway elections, crash stock markets and ruin reputations. Researchers are developing methods to limit their harm. **By Nicola Jones**

This June, in the political battle leading up to the 2024 US presidential primaries, a series of images were released showing Donald Trump embracing one of his former medical advisers, Anthony Fauci. In a few of the shots, Trump is captured awkwardly kissing the face of Fauci,

a health official reviled by some US conservatives for promoting masking and vaccines during the COVID-19 pandemic.

"It was obvious" that they were fakes, says Hany Farid, a computer scientist at the University of California, Berkeley, and one of many specialists who examined the pictures. On close inspection of three of the photos,

Trump's hair is strangely blurred, the text in the background is nonsensical, the arms and hands are unnaturally placed and the details of Trump's visible ear are not right. All are hallmarks – for now – of generative artificial intelligence (AI), also called synthetic AI.

Such deepfake images and videos, made by text-to-image generators powered by 'deep



PEOPLE'S ABILITY TO REALLY KNOW WHERE THEY SHOULD PLACE THEIR TRUST IS FALLING AWAY."

R
S
F
C
H
I

R
D
L
C
N
C
A
A

Scammed science

What can researchers do to limit the impact of fake images on science?

Science isn't immune to the problem of AI-generated fakery. One concern is the integrity of biomedical images such as scans, microscopy images and western blots – a standard technique in which distinctive bands are created by proteins of various molecular weights as they spread across a gel. Fraudsters have long faked such images using Photoshop or other image-manipulation software, but that is often detectable by a trained eye or by computers that check for image duplication. Generating images entirely with AI presents a bigger detection problem.

Last year, Rongshan Yu and his colleagues at Xiamen University, China, created scientific images using synthetic AI to see how easily it can be done. They trained one generative AI program to create new western blot images from a training data set of 3,000 images; and used another to insert features of oesophageal cancer into an image of a non-cancerous intestine. They then tested how convincing the western blots were by inviting three specialists to try to spot one fake in a set of four images; two of the experts performed worse than chance, and the third fared better by spotting a visual clue to do with the smoothness between the image and the background. A computer system did slightly better than the specialists.

In a larger study of 14,000 original western blot images and 24,000 synthetic ones, made using four different generators, Anderson Rocha at the University of Campinas, Brazil, and his colleagues found that AI detectors trained on large data sets achieved accuracies of more than 85% (ref. 8). "This is just the beginning, where we showed it's feasible. It's possible to do way

more than that," Rocha says. He and his team have a paper under review that extends their methods beyond western blots, he says.

No one *Nature* spoke to could provide proof that AI is being used by academics to beef up their papers or funding applications, but experts say it's likely. Wael Abd-Elmaged, an information scientist and computer engineer at the University of Southern California in Los Angeles, says he knows of specific cases in which academics have used AI to synthesize fakes, but declined to divulge details. Researchers investigating fake paper mills have said they have seen

"I don't know any case yet of a retracted paper that used synthetic creation to illustrate the results in that paper," says Rocha, who is working with the blog Retraction Watch on this issue. "But it's just a matter of time, I guess."

"I don't know any case yet of a retracted paper that used synthetic creation to illustrate the results in that paper," says Rocha, who is working with the blog Retraction Watch on this issue. "But it's just a matter of time, I guess."

Publishers and chief editors are certain that such tools, he says, are well-executed and all too easy to use at every level. Watermarking and other previously used methods to prevent AI-generated images and prevent their use says he plays a role in making and discussing the provenance of images. Beyond that, he encourages researchers to use tools again to detect science. At the moment, he says, it could be that

A proposal for validation of antibodies

Mathias Uhlen¹, Anita Bandrowski², Steven Carr³, Aled Edwards⁴, Jan Ellenberg⁵, Emma Lundberg¹, David L Rimm⁶, Henry Rodriguez⁷, Tara Hiltke⁷, Michael Snyder⁸ & Tadashi Yamamoto⁹









We convened an *ad hoc* International Working Group for Antibody Validation in order to formulate the best approaches for validating antibodies used in common research applications and to provide guidelines that ensure antibody reproducibility. We recommend five conceptual ‘pillars’ for antibody validation to be used in an application-specific manner.

Table 1 | Proposed conceptual pillars for validation of antibodies

Validation strategy	Genetic	Orthogonal	Independent antibody	Tagged protein expression	IMS
Validation principle	The expression of the target protein is eliminated or significantly reduced by genome editing or RNA interference	Expression of the target protein is compared with an antibody-independent method	Expression of the target protein is compared using two antibodies with nonoverlapping epitopes	The target protein is expressed using a tag, preferably expressed at endogenous levels	The target protein is captured using an antibody and analyzed using MS
Validation criteria	Elimination or significant reduction in antibody labeling after gene disruption or mRNA knockdown	Significant correlation of protein levels detected by an antibody and an orthogonal method (e.g., MS)	Significant correlation of protein levels detected by two different antibodies recognizing independent regions of the same target protein	Significant correlation between antibody labeling and detection of the epitope tag	Target protein peptides among the most abundant detected by MS following immunocapture
Suitable for these applications	WB, IHC, ICC, FS, SA, IP/ChIP, RP	WB, IHC, ICC, FS, SA, RP	WB, IHC, ICC, FS, SA, IP/ChIP, RP	WB, IHC, ICC, FS	IP/ChIP

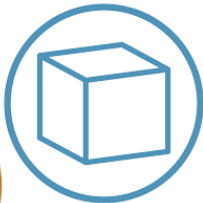
WB, western blot; IHC, immunohistochemistry; ICC, immunocytochemistry, including immunofluorescence microscopy; FS, flow sorting and analysis of cells; SA, sandwich assays, including ELISA; IP, immunoprecipitation; ChIP, chromatin immunoprecipitation; and RP, reverse-phase protein arrays.

CST Antibody Validation Principles

	Hallmark Strategy	Description
 <p>COMPLEMENTARY STRATEGIES</p>	 <p>BINARY STRATEGY</p>	<p>Binary Model: Antibody signal is measured in model systems with known presence/absence of target signal. Includes wild-type vs. genetic knockout, targeted induction or silencing.</p>
 <p>RANGED STRATEGY</p>		<p>Ranged Expression: Antibody signal strength is measured in cell lines or tissues representing a known continuum of target expression levels. Includes siRNA and heterozygous knockout assays.</p>
 <p>HETEROLOGOUS STRATEGY</p>	 <p>ORTHOGONAL STRATEGY</p>	<p>Orthogonal Data: Antibody signal is correlated to target expression in model systems measured using antibody independent assays. Includes mass spectrometry and in situ hybridization.</p>
 <p>MULTIPLE ANTIBODY STRATEGY</p>		<p>Multiple Antibodies: Antibody signal is compared to the signal observed using antibodies targeting nonoverlapping epitopes of the target. Includes IP, ChIP, and ChIP-seq.</p>
		<p>Heterologous Expression: Antibody signal is evaluated in cell lines following heterologous expression of native (or mutated) target protein.</p>
		<p>Complementary Assays: Antibody specificity may be validated using complementary assays. Includes competitive ELISA, peptide dot blots, peptide blocking, or protein arrays.</p>

Refine Results

Search Within

CLEAR ALL

Category

- Research
- Cancer (1)
 - Cell Biology (1)
 - Fibrosis (4)
 - Immunology and Immuno-Oncology (4)
 - Metabolism (1)
 - Neuroscience (4)
 - All Research Areas

- Application
- Flow Cytometry (Fixed/Permeabilized) (1)
 - Flow Cytometry (Live) (1)
 - IHC-paraffin (1)
 - Immunofluorescence (Immunocytochemistry) (1)
 - Western blot (3)

Products (4)
Content (1)

Sort By: Relevance

#	Product Name	Application	Reactivity	
98327	CD9 (E8L5J) Rabbit mAb	WB IP IHC IF F ChIP	M, R	<input type="checkbox"/> COMPARE ADD
13403	CD9 (D3H4P) Rabbit mAb	WB IP IHC IF F ChIP	H	<input type="checkbox"/> COMPARE ADD
13174	CD9 (D8O1A) Rabbit mAb	WB IP IHC IF F ChIP	H	<input type="checkbox"/> COMPARE ADD
74220	Exosomal Marker Antibody Sampler Kit			<input type="checkbox"/> COMPARE ADD

Results per page: 30 60 100 200

CD9 (E8L5J) Rabbit mAb



Orders: 877-616-CELL (2355)
orders@cellsignal.com

Support: 877-678-TECH (8324)

Web: info@cellsignal.com
www.cellsignal.com

3 Trask Lane | Danvers | Massachusetts | 01923 | USA

For Research Use Only. Not For Use In Diagnostic Procedures.

Applications:	Reactivity:	Sensitivity:	MW (kDa):	Source/Isotype:	UniProt ID:	Entrez-Gene Id:
WB, IF-IC, FC-FP, FC-L	M R	Endogenous	22-27	Rabbit IgG	P40240	12527

Product Usage Information

Application	Dilution
Western Blotting	1:1000
Immunofluorescence (Immunocytochemistry)	1:50
Flow Cytometry (Fixed/Permeabilized)	1:50 - 1:200
Flow Cytometry (Live)	1:50 - 1:200

Storage

Supplied in 10 mM sodium HEPES (pH 7.5), 150 mM NaCl, 100 µg/ml BSA, 50% glycerol and less than 0.02% sodium azide. Store at -20°C. Do not aliquot the antibody.

Specificity / Sensitivity

CD9 (E8L5J) Rabbit mAb recognizes endogenous levels of total CD9 protein.

Species Reactivity:
Mouse, Rat

Source / Purification

Monoclonal antibody is produced by immunizing animals with a synthetic peptide corresponding to residues surrounding Leu119 within the extracellular domain of mouse CD9 protein.

Background

The CD9 antigen belongs to the tetraspanin family of cell surface glycoproteins, and is characterized by four transmembrane domains, one short extracellular domain (ECL1), and one long extracellular domain (ECL2). Tetraspanins interact with a variety of cell surface proteins and intracellular signaling molecules in specialized tetraspanin-enriched microdomains (TEMs), where they mediate a range of processes including adhesion, motility, membrane organization, and signal transduction (1). Research studies demonstrate that CD9 expression on the egg is required for gamete fusion during fertilization (2-4). CD9 was also shown to play a role in dendritic cell migration, megakaryocyte differentiation, and homing of cord blood CD34+ hematopoietic progenitors to the bone marrow (5-7). In addition, downregulation of CD9 expression is associated with poor prognosis and progression of several types of cancer (8-10). Additional research identified CD9 as an abundant component of exosomes, and may play some role in the fusion of these secreted membrane vesicles with recipient cells (11).

- Hemler, M.E. (2005) *Nat Rev Mol Cell Biol* 6, 801-11.
- Le Naour, F. et al. (2000) *Science* 287, 319-21.
- Miyado, K. et al. (2000) *Science* 287, 321-4.
- Kaji, K. et al. (2000) *Nat Genet* 24, 279-82.
- Mantegazza, A.R. et al. (2004) *Blood* 104, 1183-90.
- Clay, D. et al. (2001) *Blood* 97, 1982-9.
- Leung, K.T. et al. (2011) *Blood* 117, 1840-50.
- Miyake, M. et al. (1995) *Cancer Res* 55, 4127-31.
- Higashiyama, M. et al. (1995) *Cancer Res* 55, 6040-4.
- Uchida, S. et al. (1999) *Br J Cancer* 79, 1168-73.
- Théry, C. et al. (1999) *J Cell Biol* 147, 599-610.

#98327

CD9 (E8L5J) Rabbit mAb

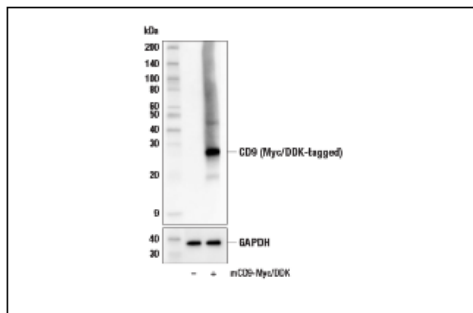

Western blot analysis of extracts from 293T cells, mock transfected (-) or transfected with a construct expressing Myc/DDK-tagged full-length mouse CD9 protein (mCD9-Myc/DDK; +), using CD9 (E8L5J) Rabbit mAb (upper) and GAPDH (D16H11) XP® Rabbit mAb #5174 (lower).

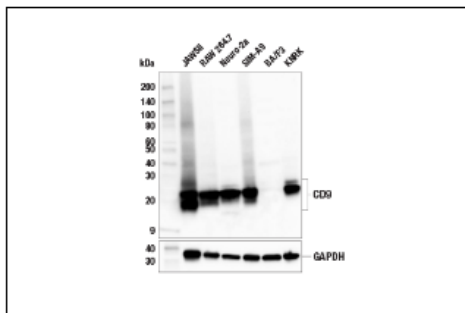

Western blot analysis of extracts from various cell lines using CD9 (E8L5J) Rabbit mAb (upper) and GAPDH (D16H11) XP® Rabbit mAb #5174 (lower). Absence of signal in BAF3 cells is predicted from RNAseq data and confirms the specificity of the antibody.

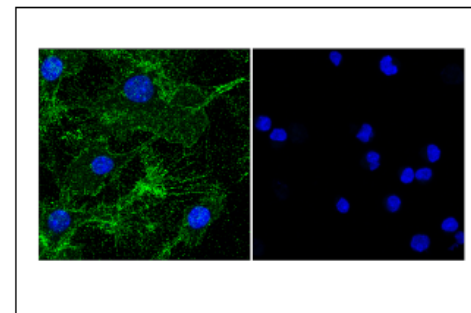

Confocal immunofluorescent analysis of RAW 264.7 cells (left, positive) or BAF3 cells (right, negative) using CD9 (E8L5J) Rabbit mAb (green) and DAPI #4083 (blue).

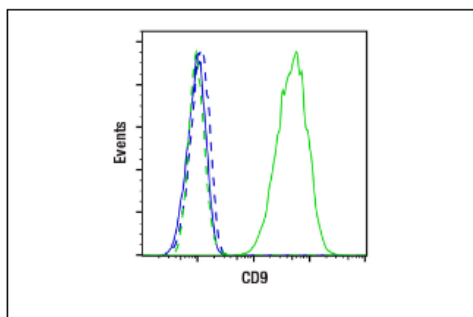

Flow cytometric analysis of live BAF3 cells (blue, negative) and JAWSII cells (green, positive) using CD9 (E8L5J) Rabbit mAb (solid lines) or concentration-matched Rabbit (DA1E) mAb IgG XP® Isotype Control #3900 (dashed lines). Anti-rabbit IgG (H+L), F(ab')₂ Fragment (Alexa Fluor® 488 Conjugate) #4412 was used as a secondary antibody.

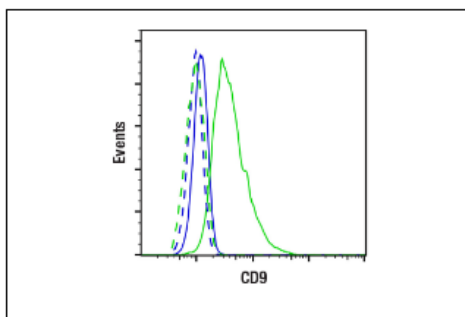

Flow cytometric analysis of fixed and permeabilized BAF3 cells (blue, negative) and JAWSII cells (green, positive) using CD9 (E8L5J) Rabbit mAb (solid lines) or concentration-matched Rabbit (DA1E) mAb IgG XP® Isotype Control #3900 (dashed lines). Anti-rabbit IgG (H+L), F(ab')₂ Fragment (Alexa Fluor® 488 Conjugate) #4412 was used as a secondary antibody.

Comment



Reproducibility: expect less of the scientific paper

Olavo B. Amaral & Kleber Neves

Make science more reliable by placing the burden of replicability on the community, not on individual laboratories.

In 2018, we embarked on a journey to assess the reproducibility of biomedical research papers from Brazil. Thus began a multicentre collaboration of more than 60 laboratories to replicate 60 experiments from 2 decades of Brazilian publications¹. We randomly selected experiments that used three common laboratory techniques: the MTT assay for cell viability, RT-PCR to measure specific messenger RNAs and the elevated plus maze to assess anxiety in rodents.

Each experiment will be repeated in three labs, and each lab has developed replication

protocols based on the original article's written methods. The process of building, reviewing and preregistering these protocols has taken months of communication between the coordinating team and the labs performing replications. We had intense arguments around the meaning of positive and negative controls and the merits of different metrics to define replication success. We also spent many hours on mundane tasks, such as studying the nutritional content of different brands of bologna sausage to better emulate a cafeteria diet fed to rats in one experiment.

These are just some of the obstacles we

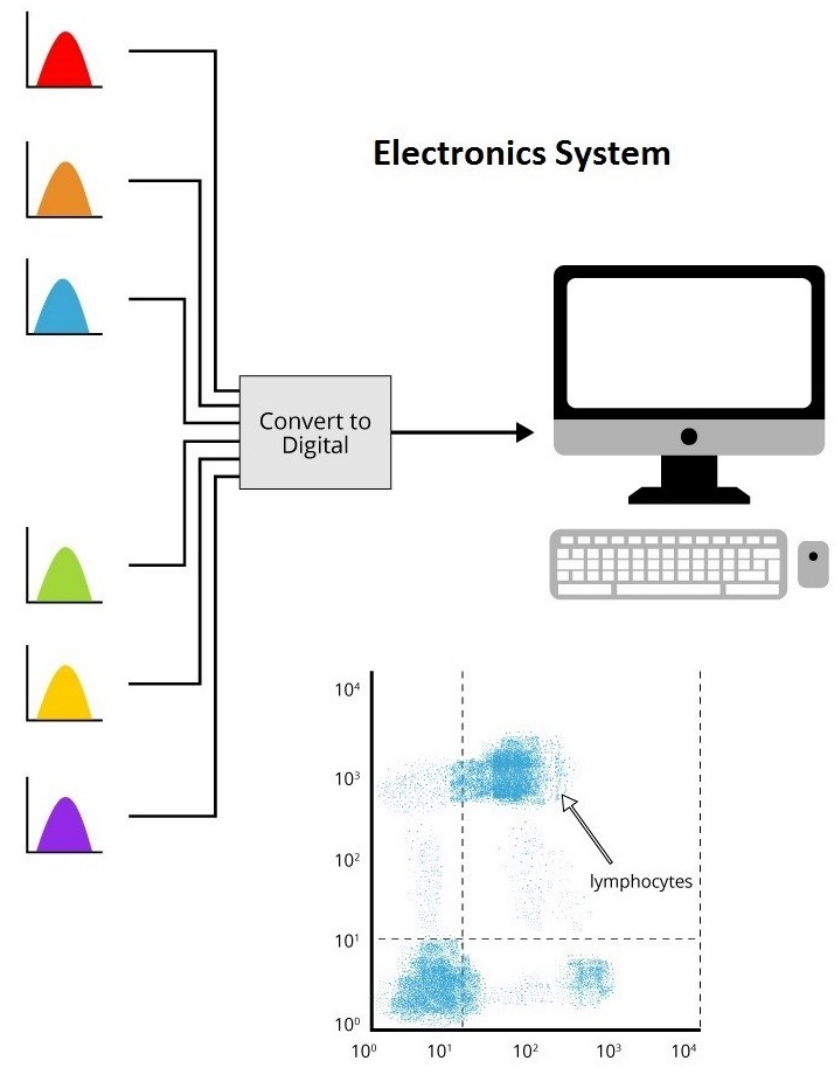
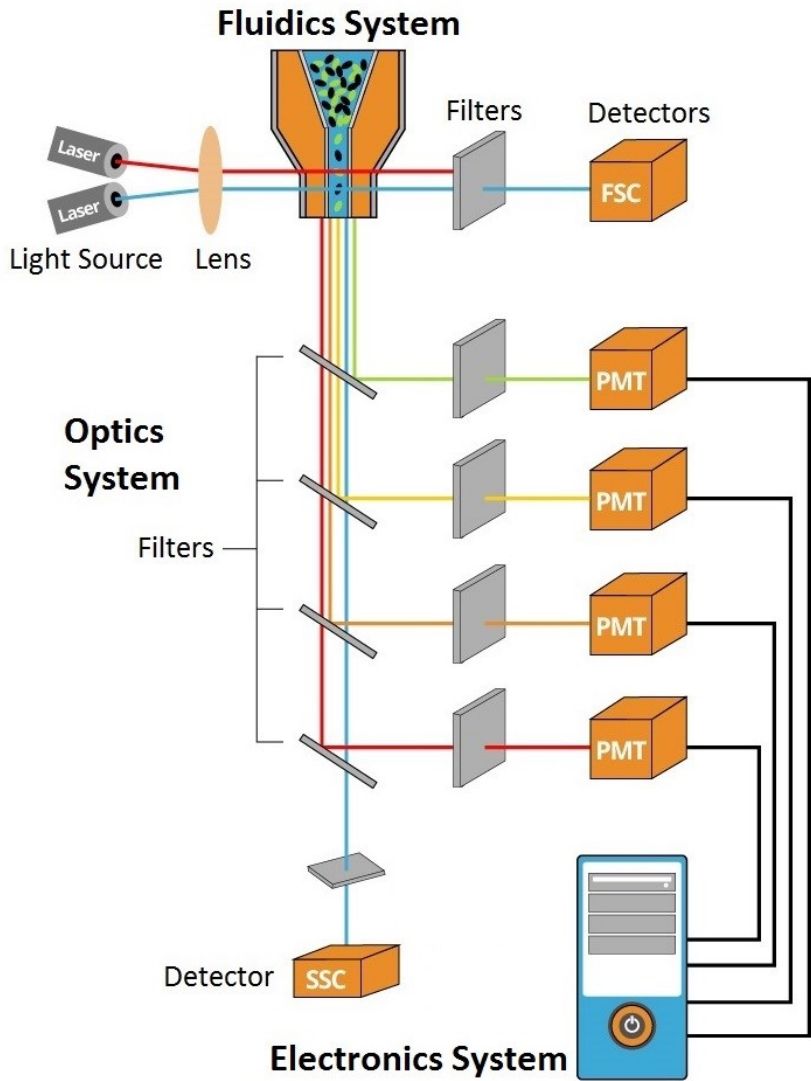

new automatic cell cloning assay (ACCA) for determination of clonogenic capacity of CSCs

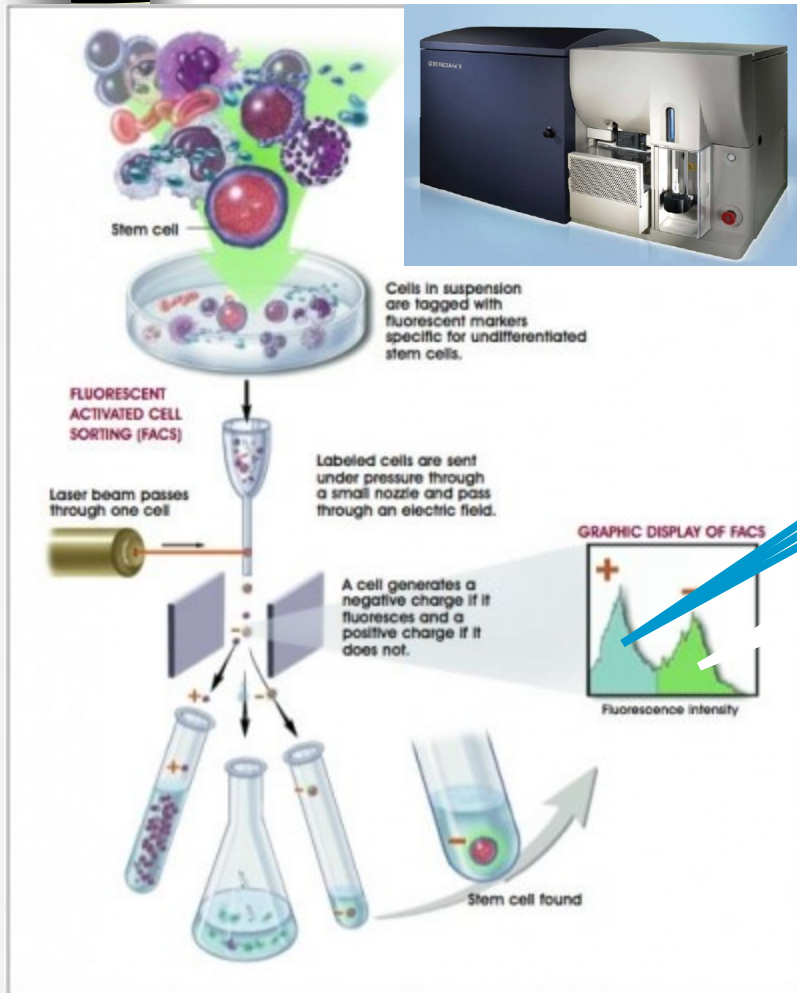

single cell/well
up to 384 well plate

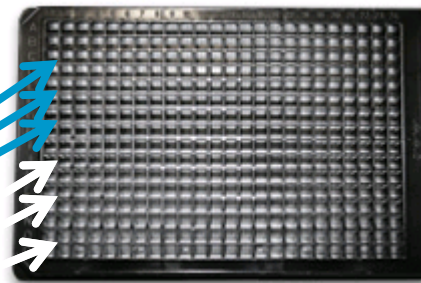

re-culture after sorting (2D, 3D)

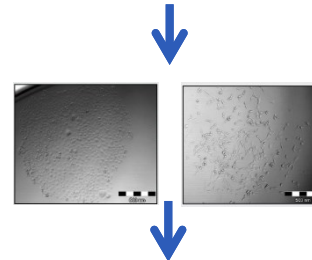

analysis: CyQuant, ATP, xCelligence, microscopy





Principles of flow cytometry and sorting

- Light
- Fluorescence
- Excitation sources, optical systems and fluorescence detection methods
- Fluid systems



Concepts

Photometry:

- **Light** - electromagnetic radiation visible to the human eye (400-750 nm, most sensitive ~ 550 nm). Measurements below 400 nm (UV, IF) are radiation detection (radiometry).
- The energy of radiation is expressed in *joules*
- **Radiant flux** is given as the value of energy over time in *watts* (1 watt = 1 joule/second)
- **photon** - elementary particle. They are described by their wavelength, frequency, energy and momentum. The lifetime of a photon is infinite (yet they arise and disappear), they exist only in motion. It has zero rest mass but non-zero energy, defined by the relation $E = h\nu$, where **h** is Planck's constant and **ν** is the frequency. Because it has energy, it is acted upon by gravity according to general relativity, and it gravitationally acts on its surroundings. (<http://cs.wikipedia.org/wiki/Foton>)
- The photon energy is expressed as $E = h\nu$ and $E = hc/\lambda$ [ν –frequency (Hz), c - speed of light (3×10^8 m/s), λ –wavelength (nm), h –Planck's constant (6.63×10^{-34} J/s)]
- **The energy** is higher at shorter wavelengths and lower at longer wavelengths.

Electromagnetic Spectrum

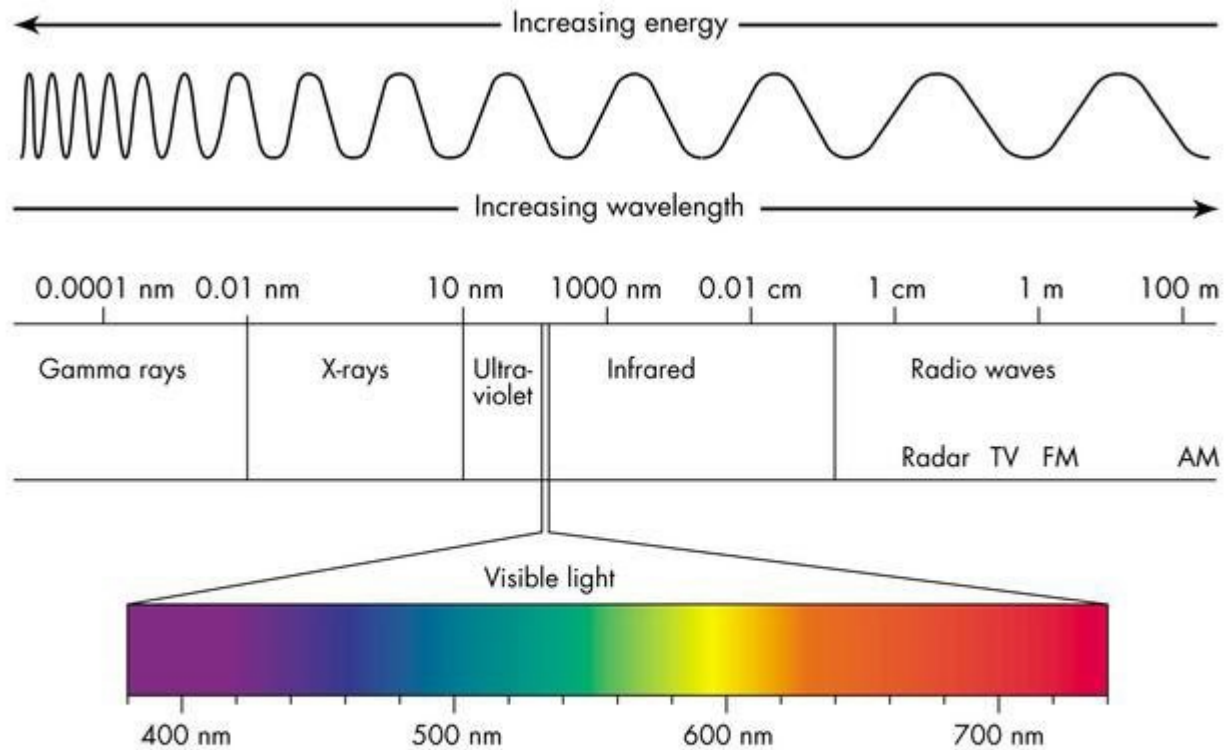

Light scattering

- Matter scatters light of wavelengths it is unable to absorb
- The visible spectrum is 350-850 nm therefore small particles and molecules ($< 1/10$) tend to scatter visible light
- For small particles, the so-called **Rayleigh scattering (scatter)** has been described whose intensity is \sim the same in all directions
- The scattering of larger particles is characterised by **Mie scattering**. Its quantity is greater in the direction in which the light falls on the irradiated particle.



Rayleigh and Mie scattering

- **Rayleigh scattering** - molecules and very small particles do not absorb, but scatter light that has a smaller wavelength than their size (blue sky - air scatters shorter wavelengths better)
- **Mie scattering** is characteristic of particles larger than the wavelength of light (white glow around the sun's disk, fog light)

<http://hyperphysics.phy-astr.gsu.edu/hbase/atmos/blusky.html>



Bending and decay of light

Short wavelengths are "bent"
more than long wavelengths

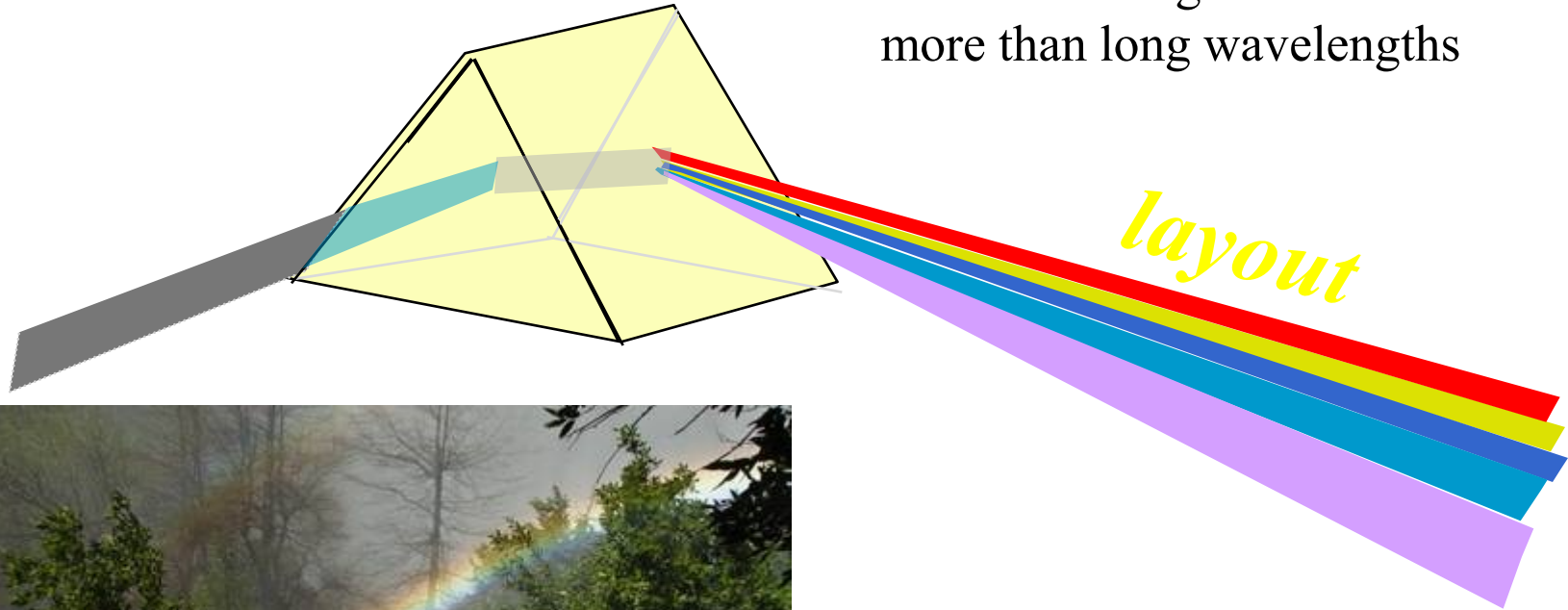

Fluorescence



George Gabriel Stokes (1819 - 1903)

English physicist and mathematician
based at the University of Cambridge



1852 - described fluorescence

The name is derived from the English word *fluospar* (fluorite, fluorspar = CaF_2 mineral) - for his observations he used a **quinine** solution, sunlight as a light source, a dark blue window glass as an excitation filter and a glass of white wine as an emission filter



<http://www.nndb.com/people/131/000097837/>

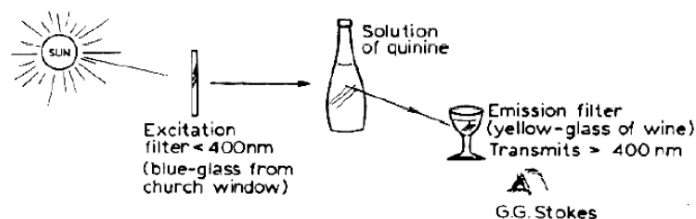

G. C. Stokes "*On the Change of Refrangibility of Light*" *Philosophical Transactions of the Royal Society of London*, 1852, vol. 142, p. 463.)

[463]

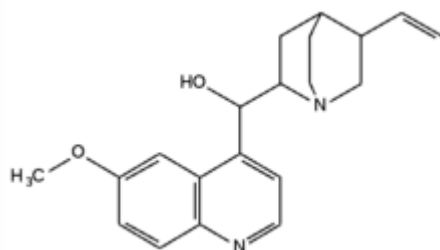

XXX. *On the Change of Refrangibility of Light.* By G. G. STOKES, M.A., F.R.S.,
Fellow of Pembroke College, and Lucasian Professor of Mathematics in the
University of Cambridge.

Received May 11,—Read May 27, 1852.

The principle of fluorescence

Fluorescence (belongs to photoluminescence radiation, which is caused either by the effect of other incident radiation or by the effect of incident particles) is the result of a three-phase phenomenon of some chemical substances - **fluorochromes**, fluorescent dyes.

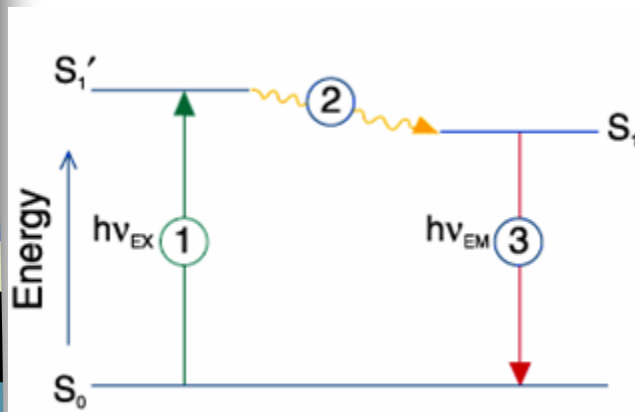

Jablonski diagram

Stage 1: Excitation

- Radiation from an external source (e.g., laser) excites the fluorophore.
- This creates an excited state (S_1').

Stage 2: Excited-State Lifetime

- The excited state lasts briefly ($1-10^{-9}$ seconds).
- The fluorophore may undergo changes and interactions.
- It loses some energy, creating a relaxed excited state (S_1).
- Some molecules don't return energy through fluorescence emission.
- This affects the fluorescence quantum yield.

Stage 3: Fluorescence Emission

- The fluorophore emits a photon and returns to its ground state (S_0).
- The emitted photon's energy ($h\nu_{EM}$) is lower and has a longer wavelength than the excitation photon ($h\nu_{EX}$).
- The difference is called the Stokes shift and is crucial for fluorescence technique sensitivity.



Fluorescence characteristics

- **intensity** - the number of photons passing in a given direction through a unit area per unit time
- **spectral composition** - spectral density of photon flux per unit interval of wavelengths or frequencies
- **polarization** - the direction of oscillation of the electric vector of an electromagnetic wave
- **the time of extinction** - is determined by the internal lifetime of the excited state from which the emission occurs; it is closely related to the processes leading to the non-radiative deactivation of this state
- **coherence properties** - relationships between the phases of light waves

Fluorescence spectra

The fluorescence process is cyclic.

In addition to the fluorochrome irreversibly destroyed (photobleaching), it can be repeatedly excited.

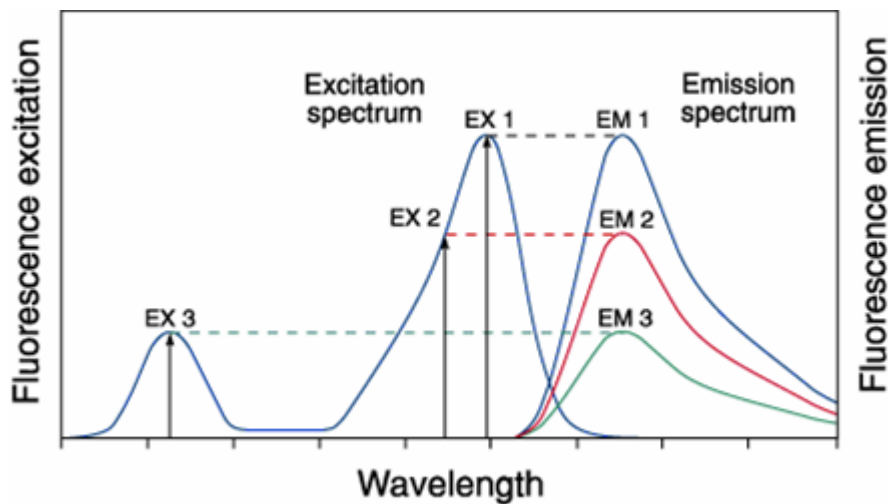

Excitation of a fluorophore at three different wavelengths (EX 1, EX 2, EX 3) does not change the emission profile but does produce variations in fluorescence emission intensity (EM 1, EM 2, EM 3) that correspond to the amplitude of the excitation spectrum.



Fluorescent dyes

- Fluorescent dyes (fluorophores, fluorochromes) are chemical compounds that contain a reactive group in their molecule that is able to react with nucleophilic groups (NH_2 , OH , SH).
- In general, fluorophores are divided into intrinsic and extrinsic.

Internal fluorescence

- The internal fluorescence of cells is determined by the presence of internal fluorophores, which include proteins, reduced forms of NADH and NADPH, vitamin A, cytochromes, peroxidase, hemoglobin, myoglobin, and chlorophyll.
- Proteins emit fluorescent radiation in the UV region of the spectrum. The main fluorophores in proteins are aromatic amino acids (phenylalanine, tryptophan, tyrosine), whose absorption and emission bands lie between 240 and 300 nm.
- The other substances listed emit in the visible region of the spectrum (blue, yellow or red).

External fluorescence

- External fluorophores are used much more often than internal ones.
- They are added to the sample under study and are divided into fluorescent tags and fluorescent probes according to the type of binding.

Fluorescent markers

- They are most commonly used to fluorescently label proteins to which they bind by covalent linkage.
- The best known fluorescent labels are FITC (fluorescein-5-isothiocyanate) and TRITC (tetramethylrhodamine-5-isothiocyanate, tetramethylrhodamine-5-isothiocyanate).

Fluorescent probes

- external fluorophores, which bind to the structure by non-covalent bonding and often change their fluorescence properties in the process. These fluorophores are used to study changes in protein conformation, membrane thickness, membrane potential, etc.
- A number of fluorescent probes (e.g., acridine orange, ethidium bromide, DAPI, etc.) are used to identify and visualize nucleic acids.
- The best known and most widely used fluorescent probe for visualizing all nuclear DNA is DAPI. Chemically, it is 4',6-Diamidino-2-phenylindole. Its absorption maximum is at 345 nm, its maximum fluorescence is at 455 nm (blue fluorophore)
- Another frequently used fluorophore is acridine orange. This is a fluorescent probe whose absorption and emission bands vary according to the substrate to which the DNA/RNA is bound. Both of these are usually supplied in the form of chloride salts.

Fluorescence detection

Equipment for fluorescence

- (1) excitation source
- (2) fluorochrome
- (3) wave filters for isolating emitted photons from excited photons
- (4) detectors for registering emitted photons

Fluorescence instruments

- The spectrofluorometer measures the average properties of the sample volume in the cuvette.
- fluorescence microscope describes fluorescence as a phenomenon in a spatial coordinate system
- flow cytometer measures fluorescence in the flow stream, allowing detection and quantification of subpopulations within a large sample

Fluorescent signal

- The spectrofluorometer is flexible, allowing you to measure fluorescence at various excitation and emission wavelengths
- flow cytometer needs fluorescent markers that are excitable at a certain wavelength.

Background fluorescence

- endogenous components - autofluorescence
- unbound or non-specifically bound markers = reagent background

Multi-colour marking

- two or more brands, while monitoring various functions
- necessary to select excitation source, markers and separation filters appropriately

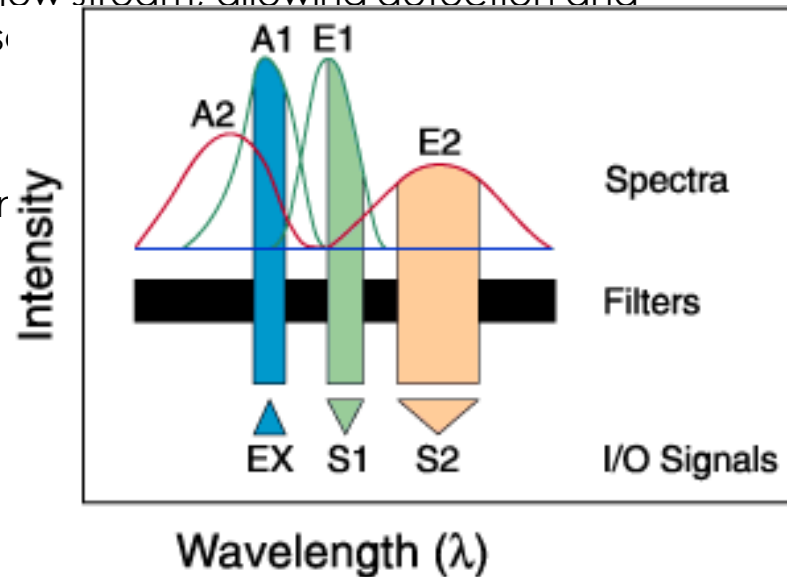

Fluorescence Output of Fluorophores

Comparing Different Dyes

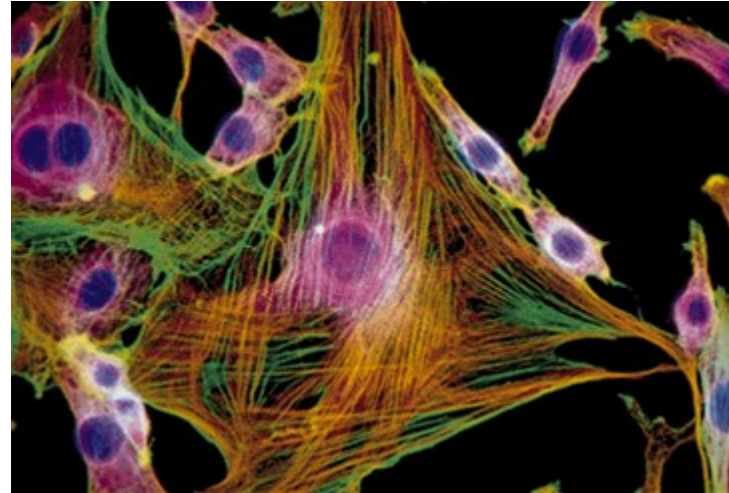
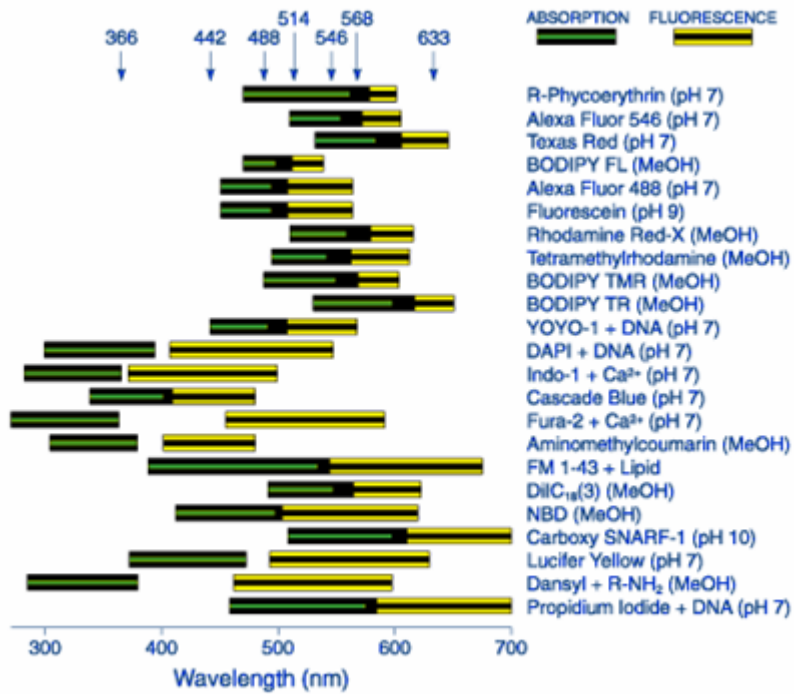

Mouse 3T3

F-actin ~
BODIPY FL phalloidin

anti-β tubulin ~
Texas Red
goat anti-mouse IgG

DNA ~
DAPI

POPO-1 BOBO-1 YOYO-1 TOTO-1 JOJO-1 POPO-3 LOLO-1 BOBO-3 YOYO-3 TOTO-3

λ Hind III

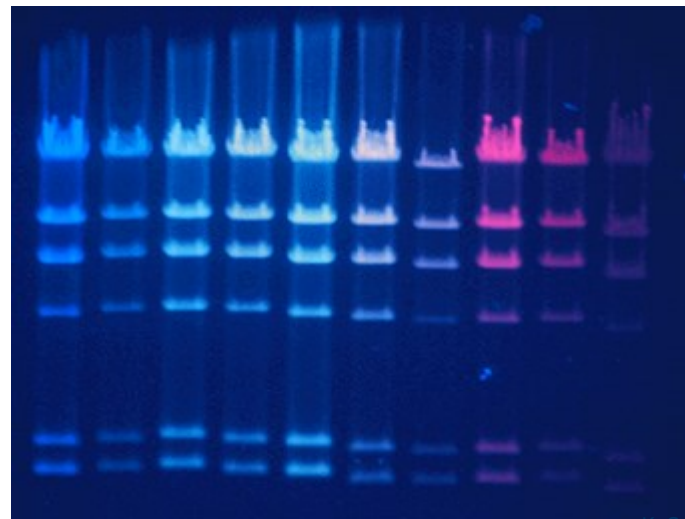
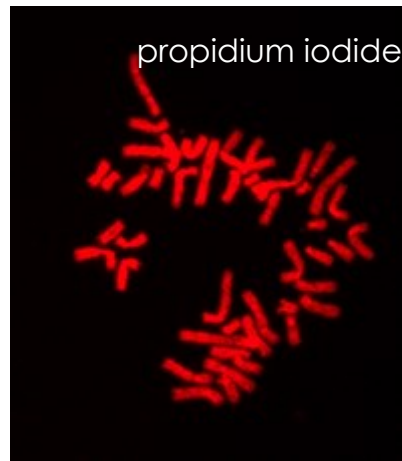

Fluorochrome chart

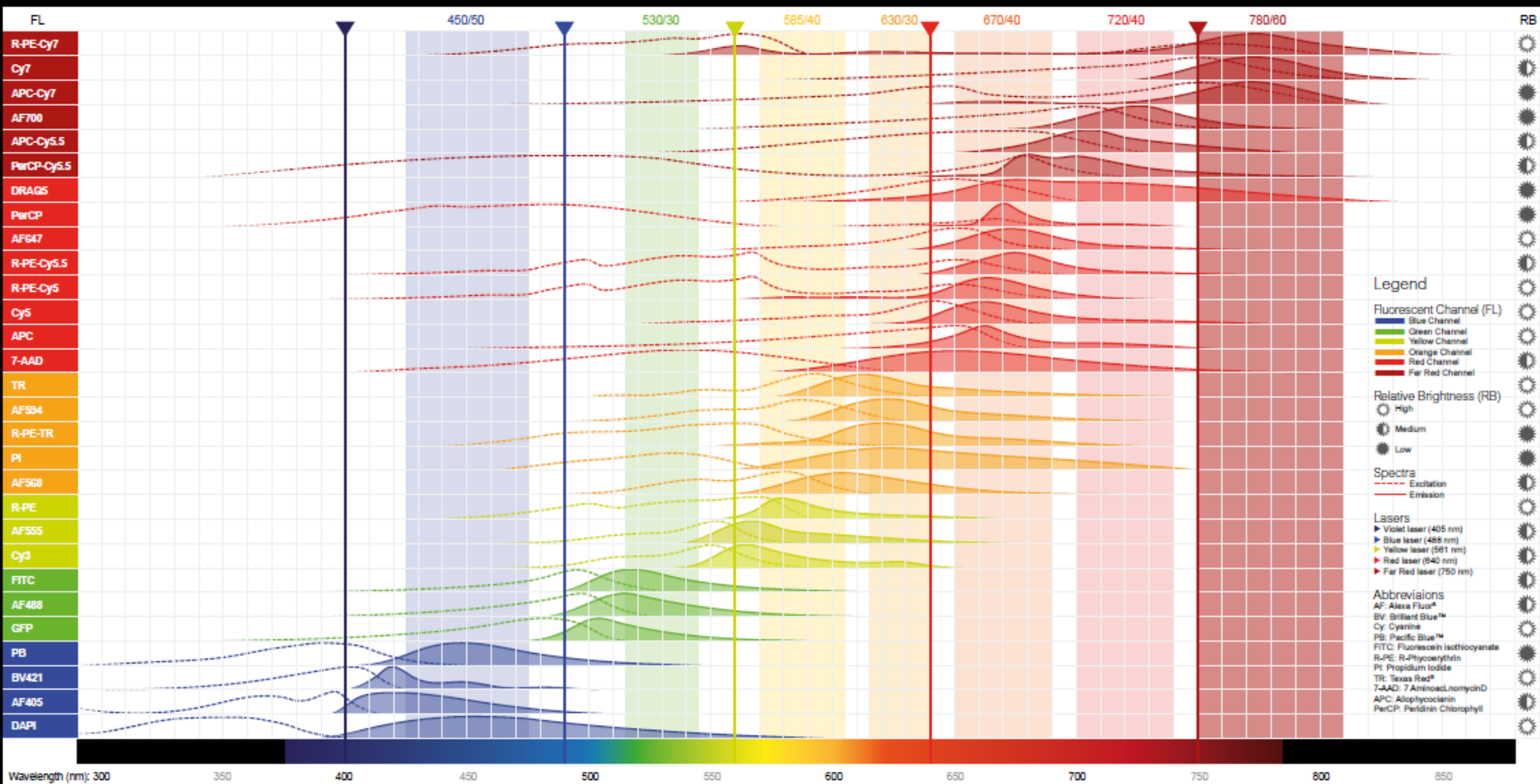



Processes interfering with and detecting fluorescence

- **Quenching** - "quenching" fluorescence with polar solvents, heavy ions.
- **Bleaching** - a change in the structure of a fluorescent molecule leading to a loss of fluorescence (by light or chemical interaction).
- **Photon saturation** - a state where the amount of molecules in the excited state corresponds to the amount of molecules in the basal level

Photobleaching

- irreversible destruction or photobleaching of the excited fluorophore

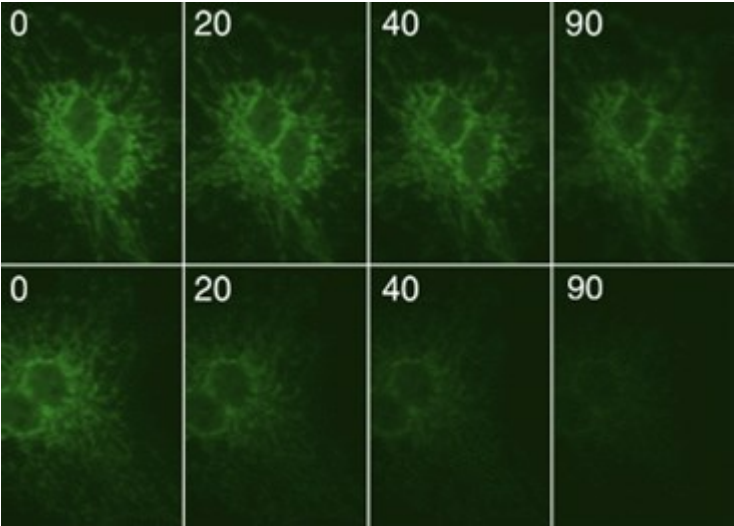

anti-human cytochrome oxidase subunit I

Oregon Green 514 goat anti-mouse IgG

fluorescein goat anti-mouse IgG



The basis of flow cytometry



Fluidics

Optics

Electronics

Cells in suspension
flow individually across
illuminated part where
scatter light and emit
fluorescence,
that is detected, filtered and
converted to digital values
saved to the computer



Optics - light source

- the need to focus the light source at the same place where the cell flow is focused
- Lasers
 - produce a single wavelength of light (325, 488, ~630nm)
 - provide mW - W of light
 - provide a coherent light current
- Arc-lamps (Arc-lamps), not used in current systems
 - produce a **mixture of** wavelengths that must be filtered
 - provide mW of light
 - cheap - air-cooled
 - incoherent light current

- optical channels

- the path of light from the point of cell irradiation to the detector
- optical parts **separate** certain wavelengths

LASER(s)

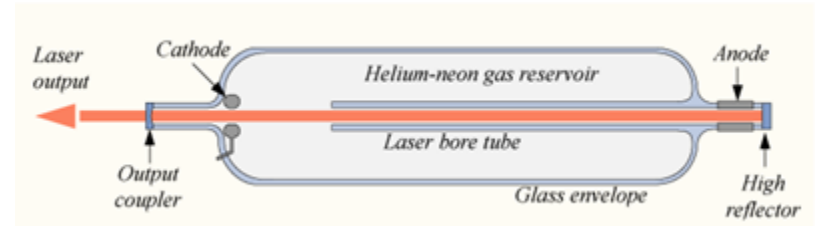
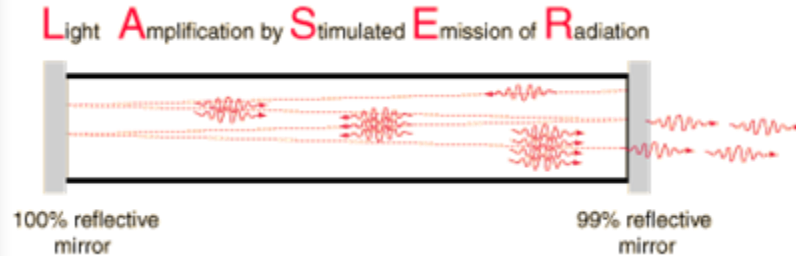

http://en.wikipedia.org/wiki/Helium-neon_laser

- coherent (continuous luminous flux)
- Monochrome
- Focused

<http://hyperphysics.phy-astr.gsu.edu/hbase/hframe.html>

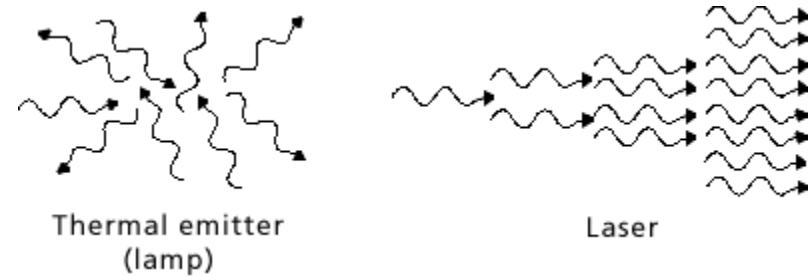

<http://www.ilt.fraunhofer.de/eng/100053.html>



LASER vs. Arc lamp

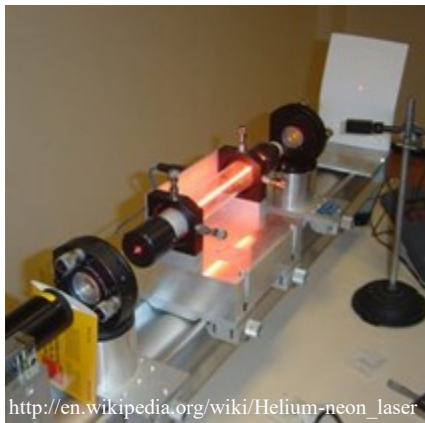
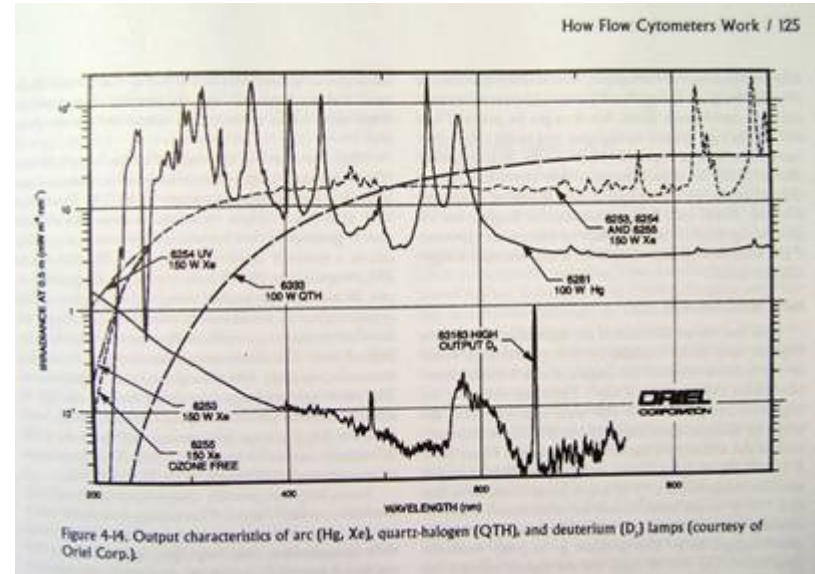
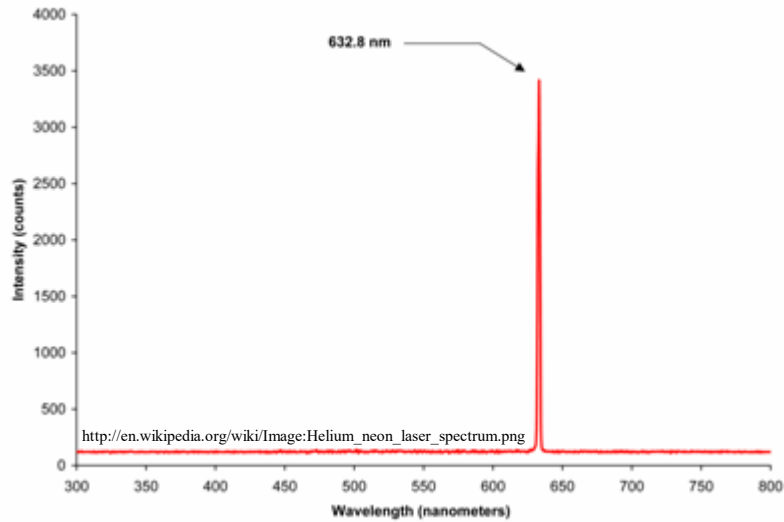

H.M. Shapiro, Practical Flow Cytometry, 4th ed.



<http://www.olympusmicro.com/primer/anatomy/sources.html>



Optics - "Forward Scatter" channel

- the portion of light scattered in the same axis as the direction of the light beam
- the intensity of the "forward scatter" corresponds to the **size, shape and optical homogeneity** of the cells

Forward Angle Light Scatter

Laser

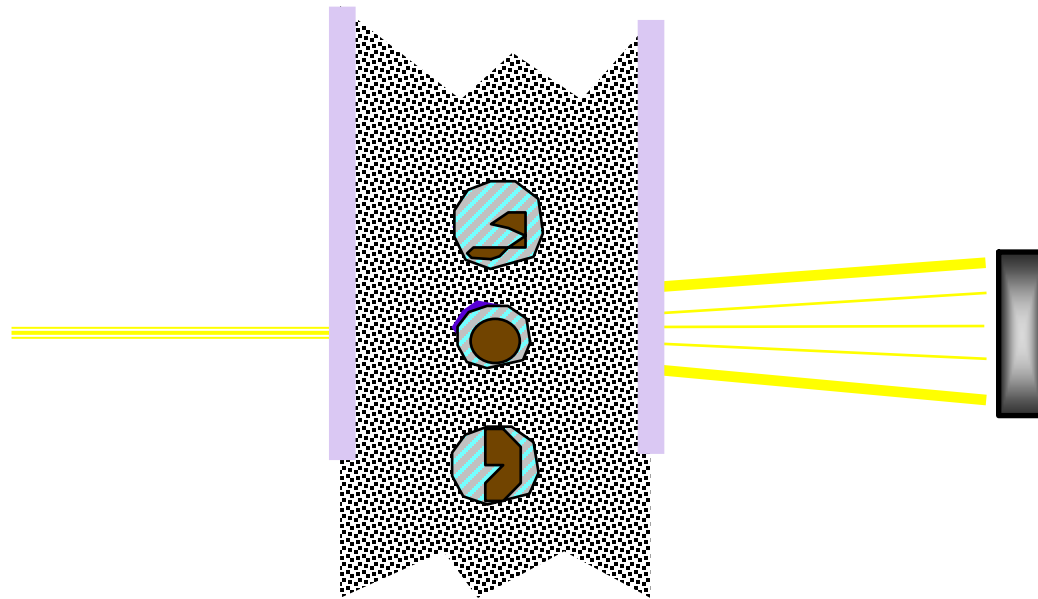
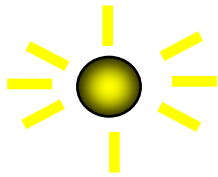

FALS
Sensor



Optics - "Side Scatter" channel

- the part of the light scattered perpendicularly to the side of the axis of light beam direction **side (90°) scatter channel**
- the intensity of the "side scatter" corresponds to the **size, shape and optical homogeneity of the cells**

90 Degree Light Scatter

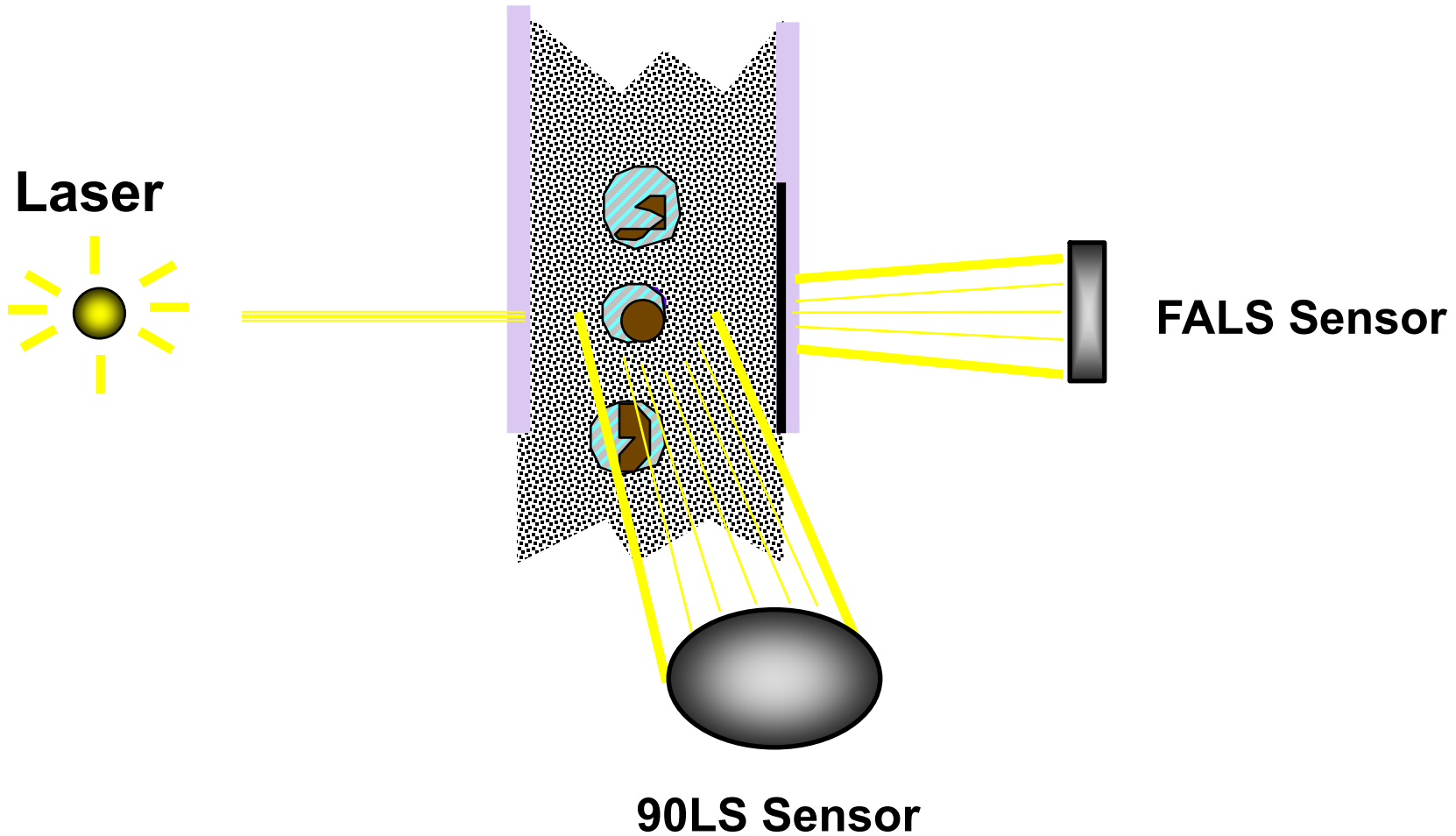



Optics - Light Scatter

- "Forward scatter" captures **surface properties and particle size**
- can be used to distinguish between living and dead cells
- "Side scatter" corresponds to **inclusions within** cells
 - it is possible to distinguish between **granular** and **non-granular** populations



Optics - fluorescent channels

- the fluorescence emitted from each fluorochrome is detected by a **specific fluorescence channel**
- specificity of detection is controlled by the wave selectivity of the filter and mirrors

Fluorescence Detectors

Laser

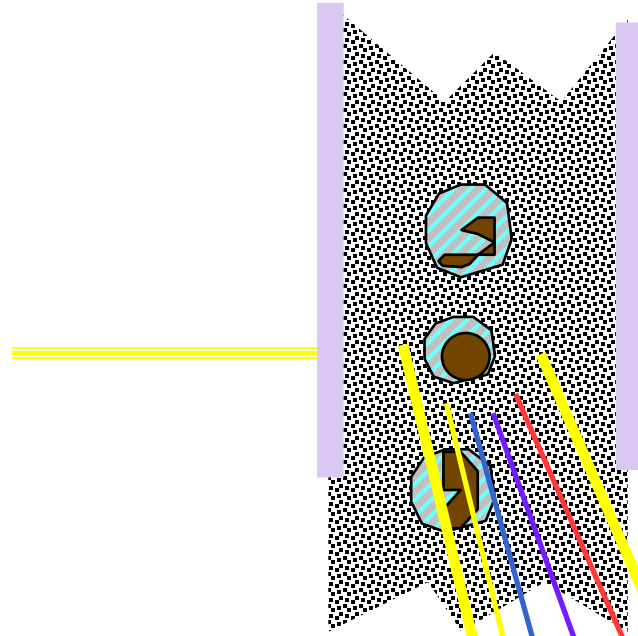
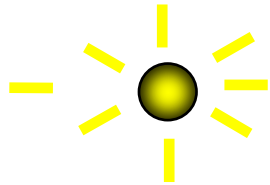

FALS Sensor

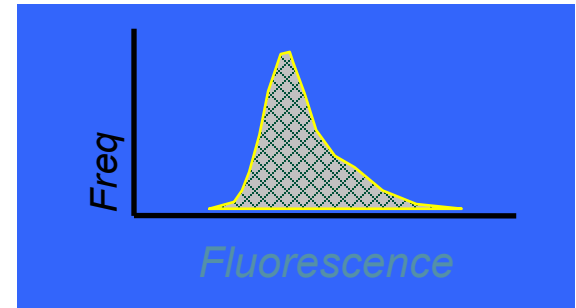
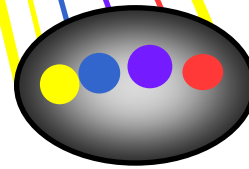
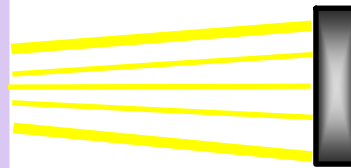

Fluorescence detector
(PMT3, PMT4 etc.)

Optics - filter properties

- are constructed of materials that absorb a certain wavelength (and transmit another)
- the transition between absorbance and transmission is not exact; it is necessary to specify the refraction of light in the filter design





Optics - filter properties

- "Long pass" filter passes wavelength **above the** "cut" length
- "Short pass" filter passes wavelength **below the** "cut" length
- The "Band pass" filter passes a wavelength in **a narrow range** around the specific wavelength

Standard Long Pass Filters

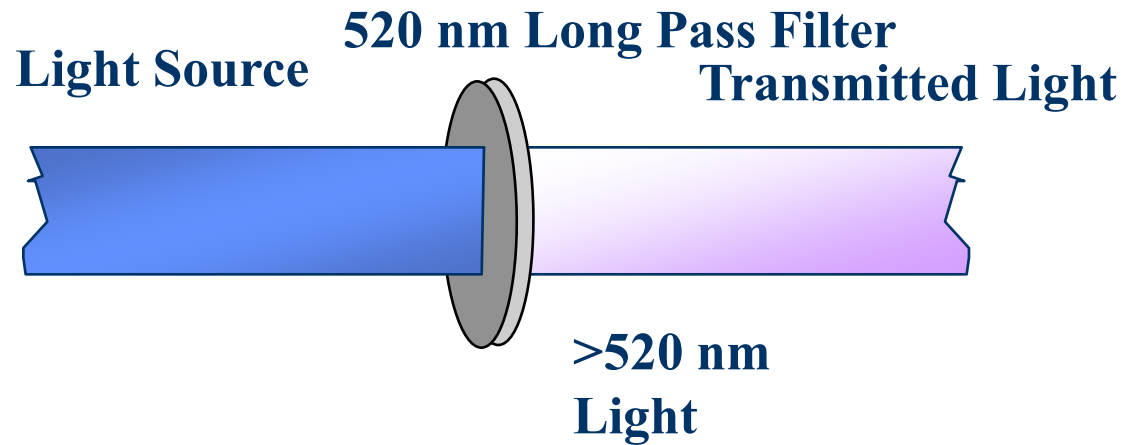

Standard Short Pass Filters

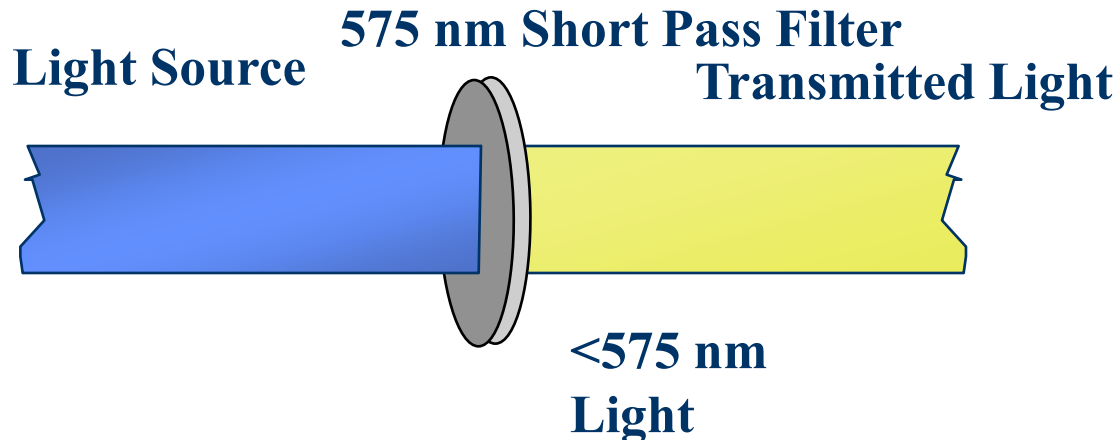

Standard Band Pass Filters

630 nm BandPass Filter

White Light Source

Transmitted Light

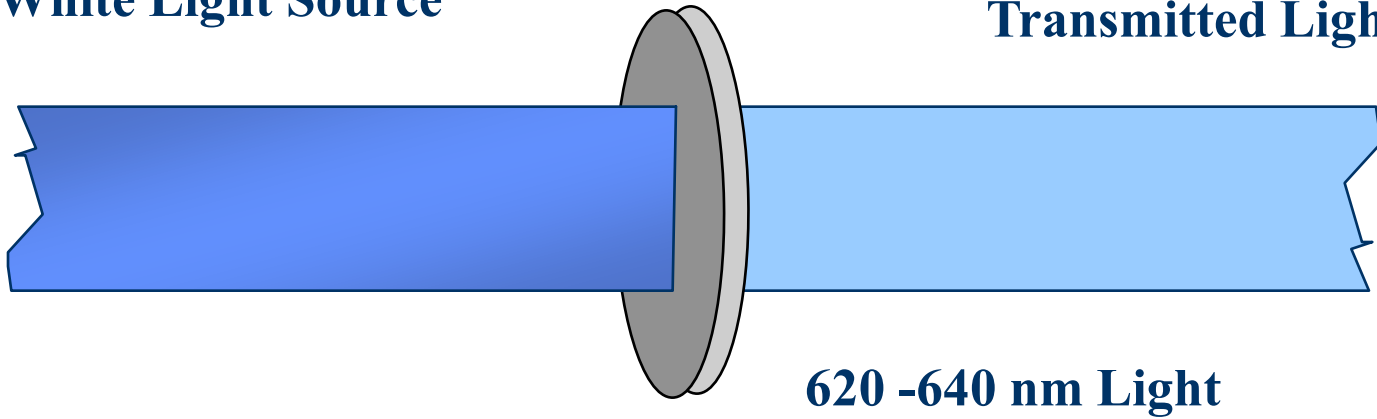



Optics - filter properties

- if the filter is placed at a **45° angle** to the light source, the light that is supposed to pass through does so, but the blocked light is reflected at a 90° angle
- **dichroic filters, dichroic mirrors**

Dichroic Filter/Mirror

Filter placed at 45°

Light Source

Transmitted Light

Reflected light

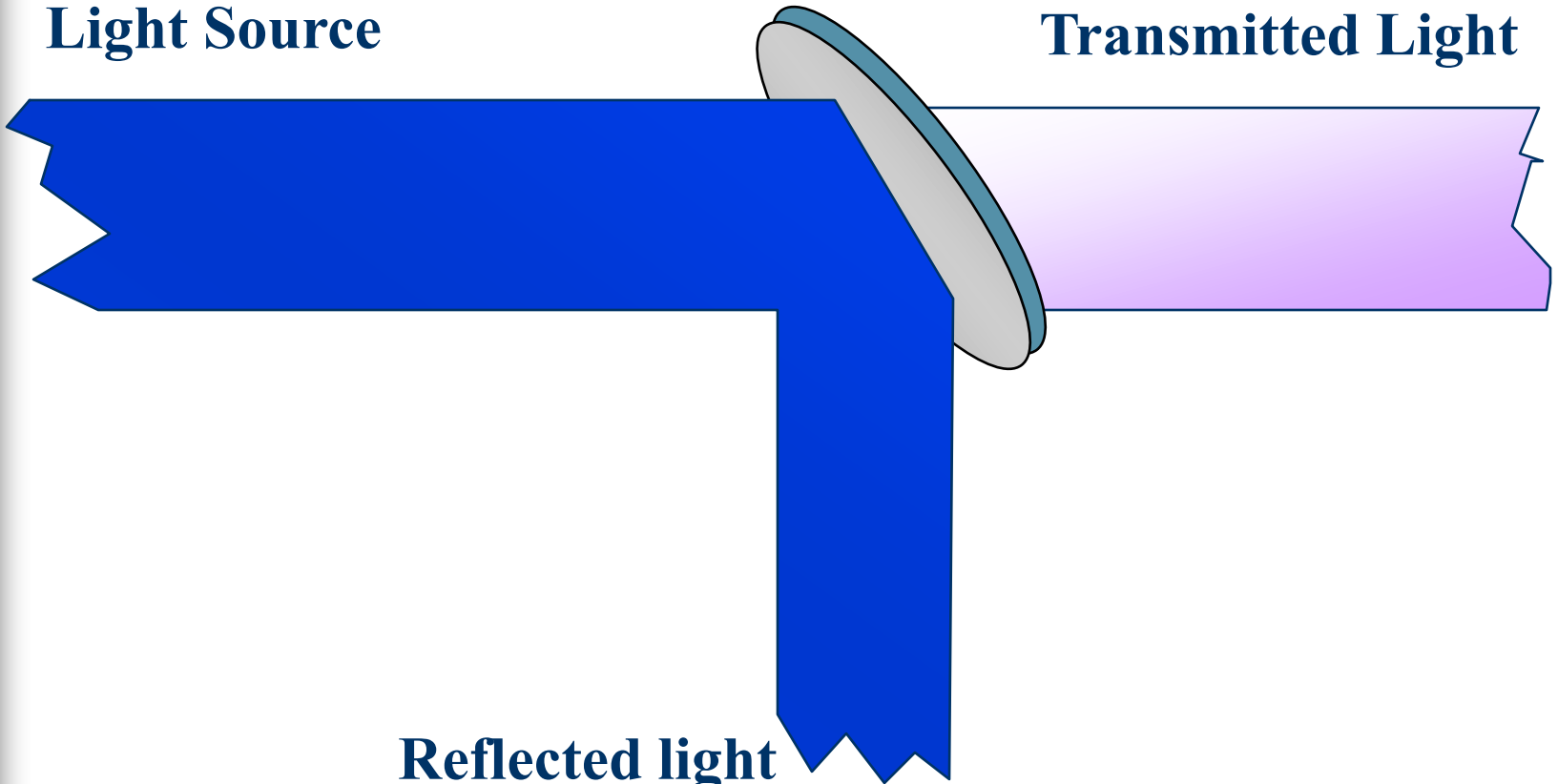



Optics - filter arrangement

- to measure more than one "scatter" or fluorescence together, we use **multiple channels** (and detectors)
- the multi-channel arrangement must meet
 - **spectral properties** of the fluorochrome used
 - **the correct order of arrangement** of filters and mirrors



Optics - detectors

- two general types of detectors
 - **photodiode**
 - in the past especially for strong signal (forward scatter detector)
 - present - highly sensitive AVALANCHE" photodiodes (APD)
 - **photomultiplier tube (PMT)**
 - more sensitive than a normal photodiode, can be damaged by overexposure

Photomultiplier tubes (photomultipliers, PMTs)

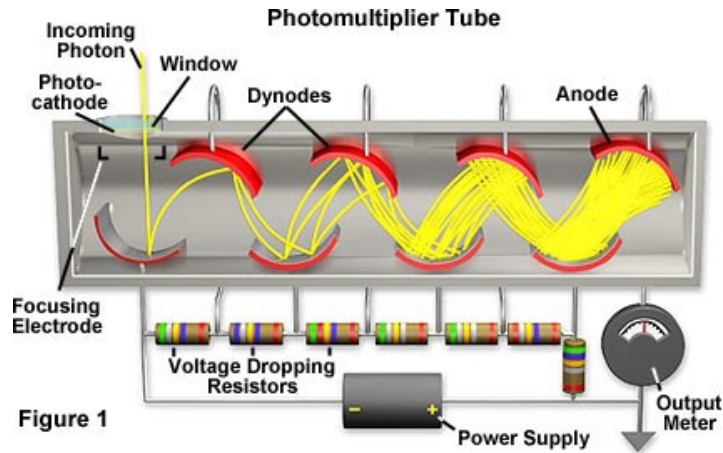

Basic characteristics:

- high sensitivity detectors (single photon)
- high signal gain/low noise
- large detection area
- fast response frequency
- high working voltage (1000 - 2000 V)

<http://en.wikipedia.org/wiki/Photomultiplier>

<http://hamamatsu.magnet.fsu.edu/articles/photomultipliers.html>



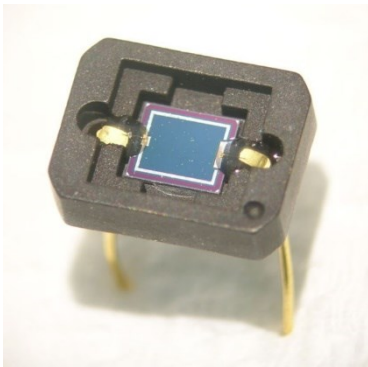

<http://en.wikipedia.org/wiki/Photodiode>

"normal" photodiode

Comparison with PMT

Advantages:

1. excellent signal linearity
2. spectral detection range 190 nm to 1100 nm (silicon)
3. low noise
4. Resistance to mechanical influences
5. low price
6. small size and weight
7. long service life
8. High quantum efficiency (~80%)
9. Does not need high voltage

Disadvantages

1. Small area
2. Impossibility of integral amplification
3. Much lower sensitivity
4. Counting photons only for special products
5. Shorter response time

Present: the "AVALANCHE" photodiode (APD)

- Highly sensitive semiconductors - comparable to PMT

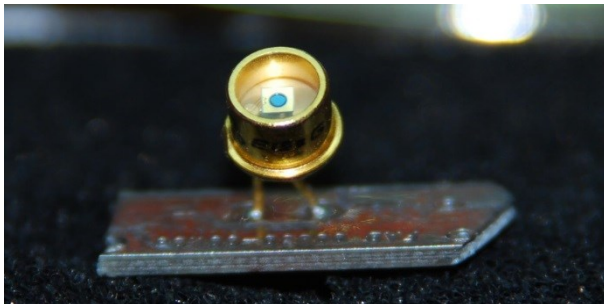

https://en.wikipedia.org/wiki/Avalanche_photodiode

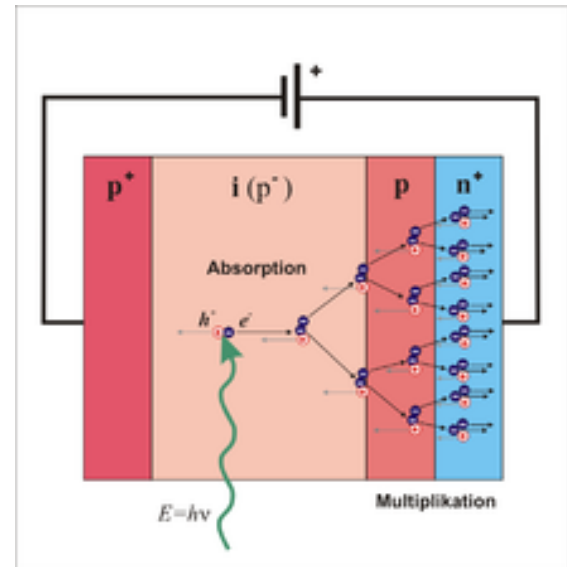

Example Channel Layout for Laser-based Flow Cytometry

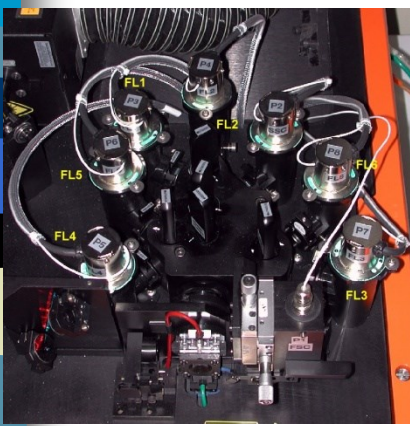

Flow cell

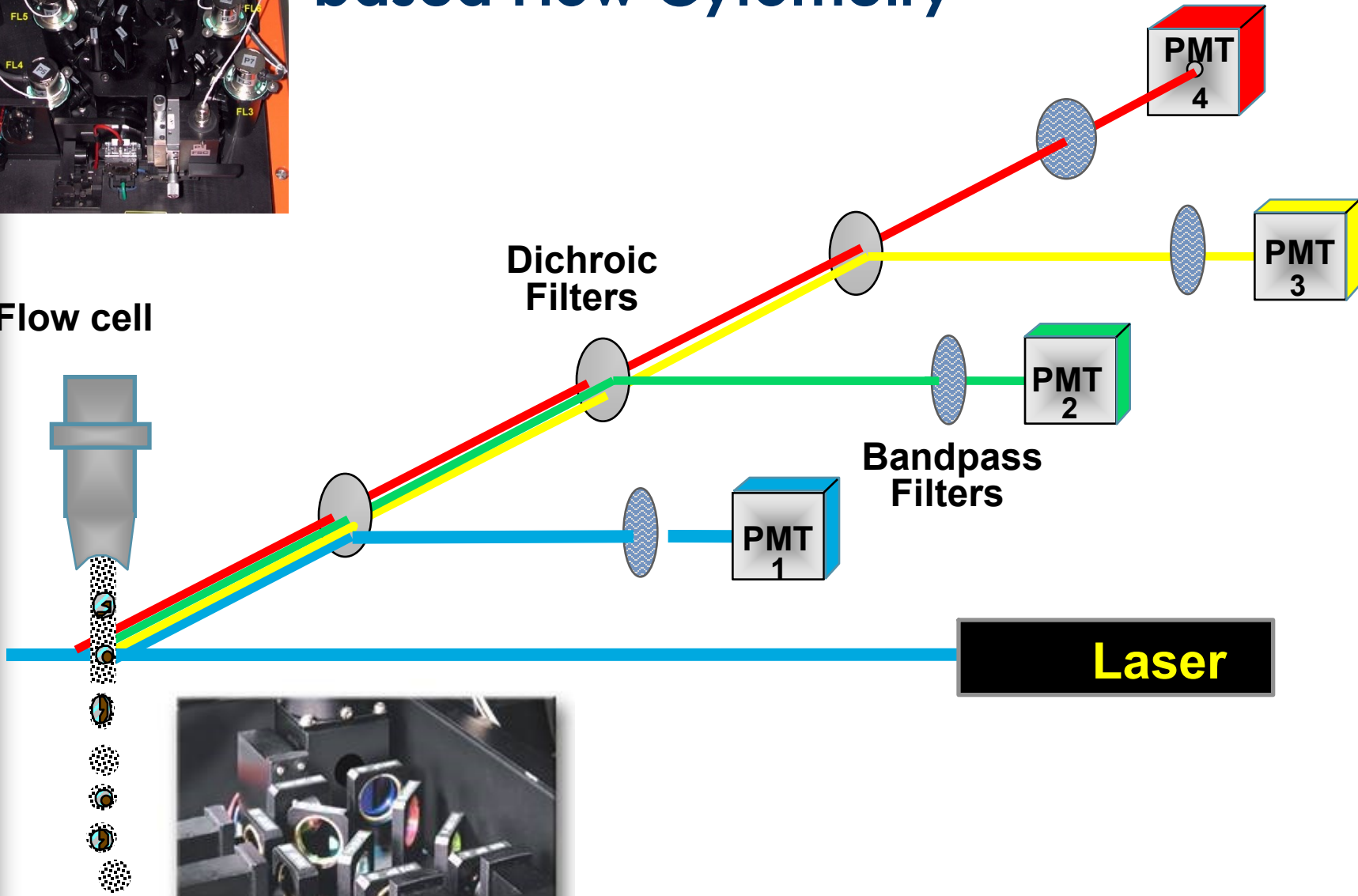

BD FACSCalibur system

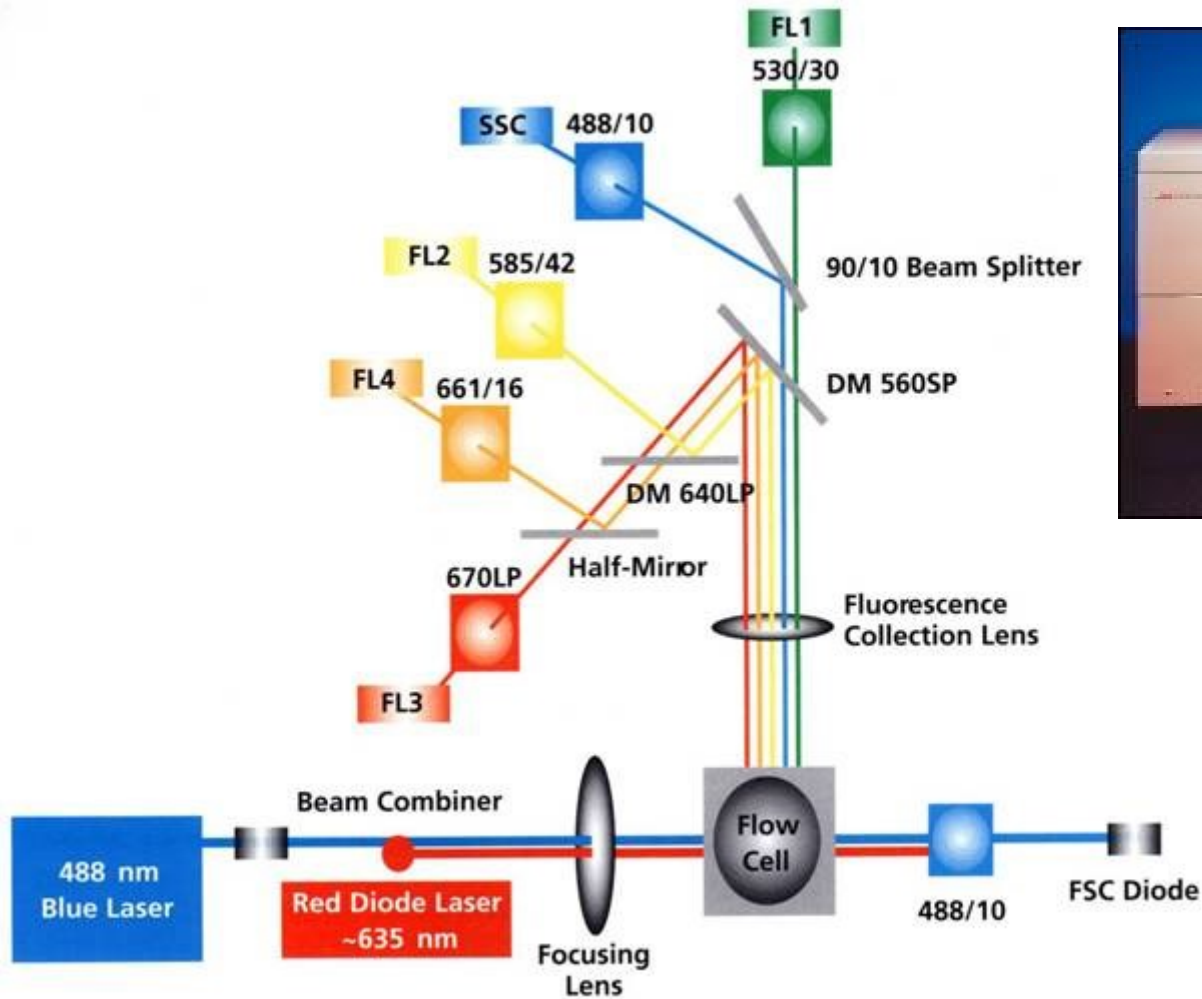

http://www.bdbiosciences.com/immunocytometry_systems/

BD LSR II system

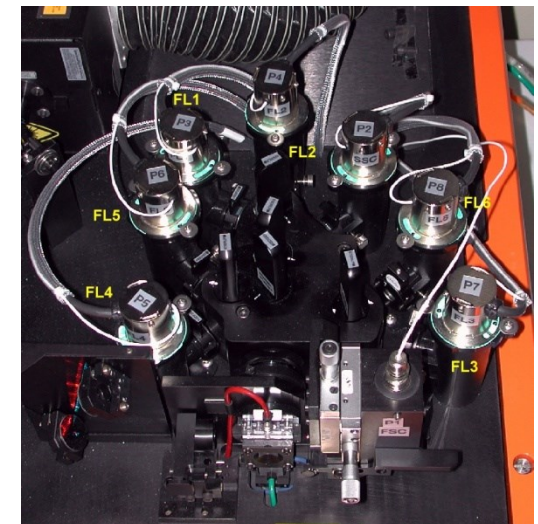
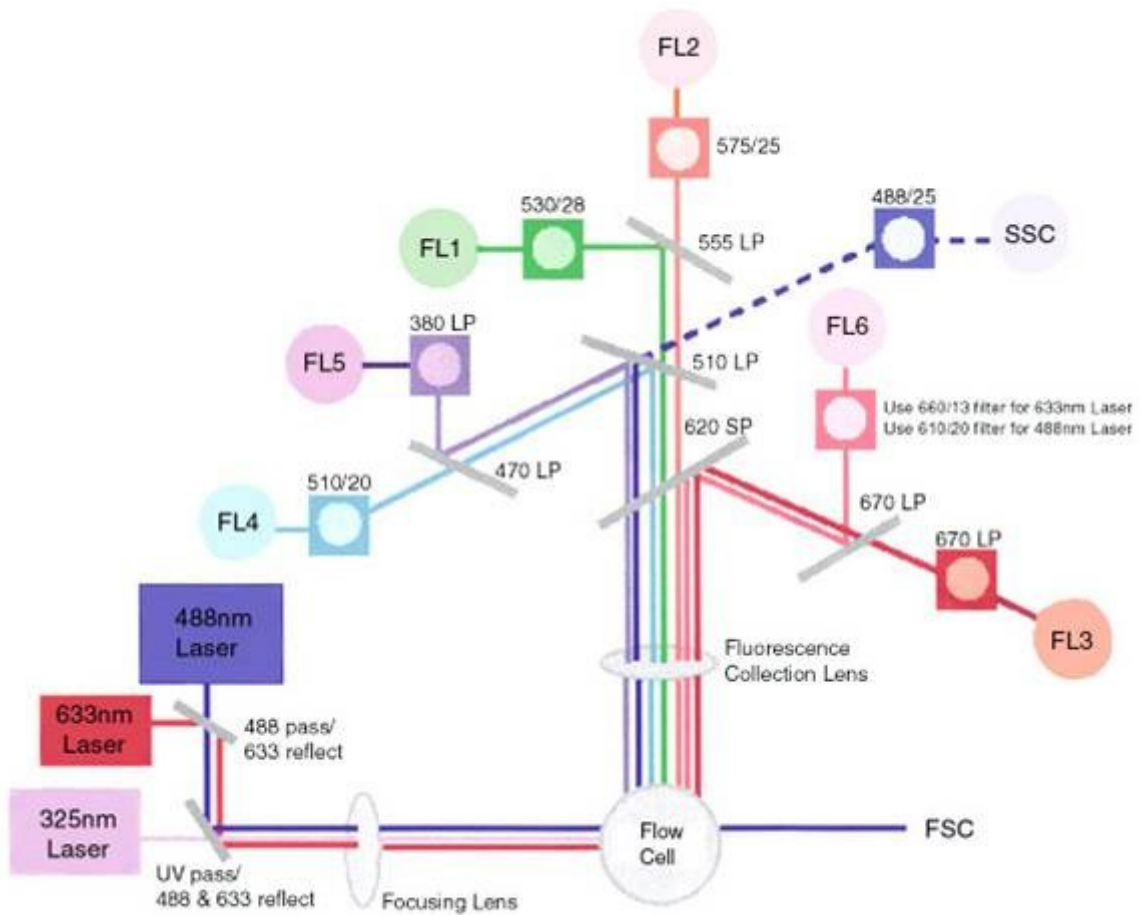

BD FACSVerser system

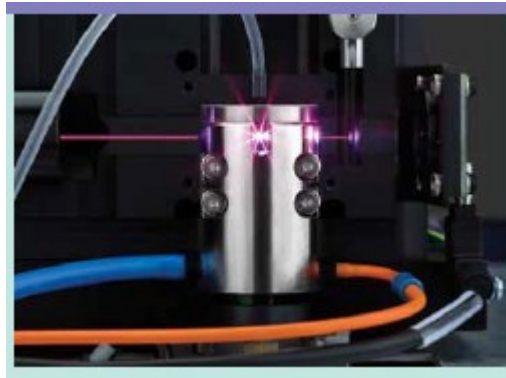

<http://www.bdbiosciences.com/instruments/facsverse/features/index.jsp>

Aria II

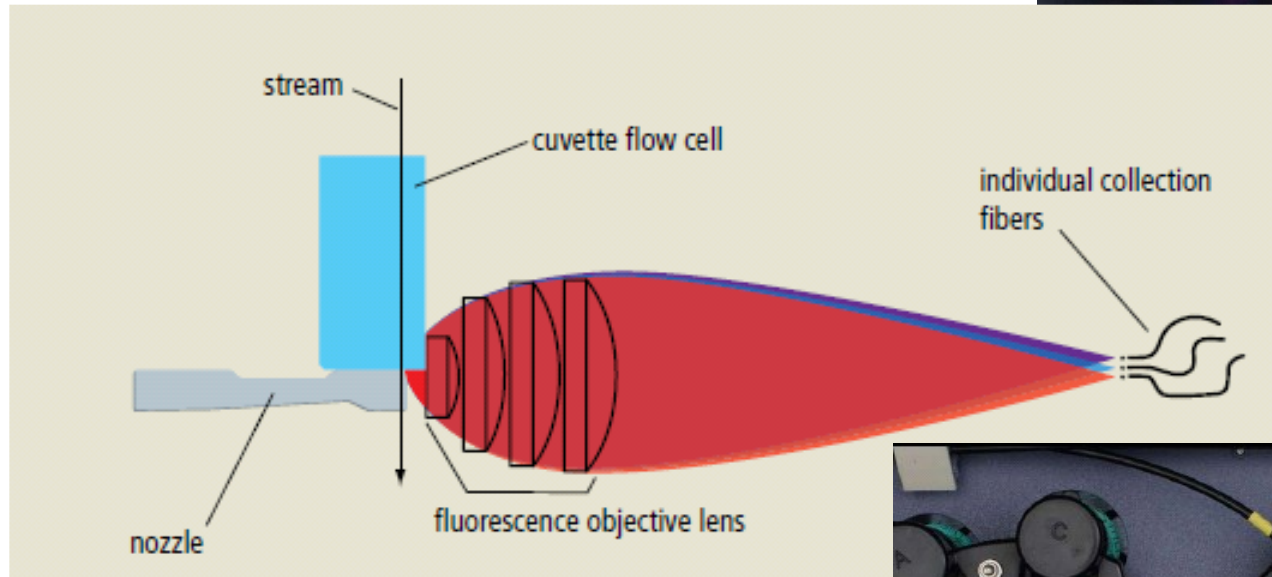

SP6800 spectral analyzer

The 405nm, 488nm and 638nm excitation lasers are positioned to reduce fluorescent noise. They enable the system to support 16 or more fluorescent parameters.

Microfluidics flow cell chip maximizes signal with auto positioning to guarantee high sensitivity. Made of durable plastic with an embedded quartz cuvette, the chip is easy to replace when needed.

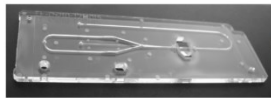

The **Flowpoint detection system** precisely tracks the core stream shape and position in the flow cell as well as the cross sectional position of each passing particle to provide highly reliable measurements. This patented technology visualizes core stability and enables the highest resolution.

Scatter analysis

Forward and Side Scatter parameters to allow relative size and complexity measurements.

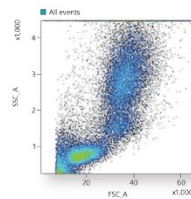

Emitted light is directed through a **32 Channel PMT** that produces 66 data points of signal detection to analyze emitted photons from 420nm to 800 nm to ensure accurate visualization.

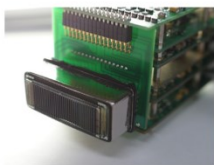

A unique prism collection system

Delivers light through 10 consecutive prisms allowing optimal signal separation while minimizing light loss.

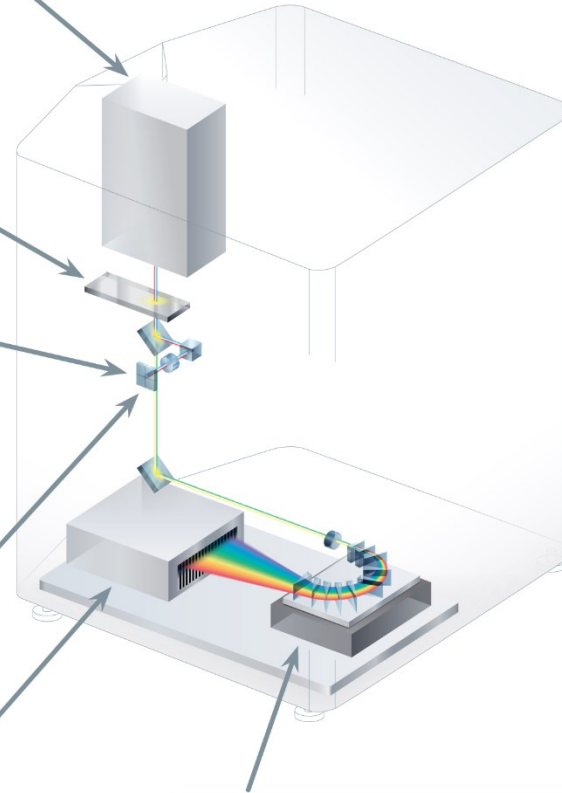
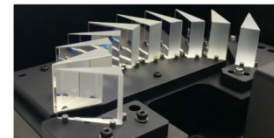
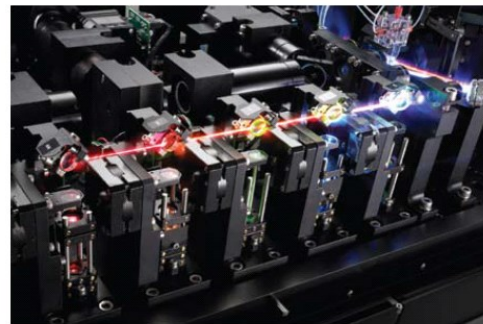

Image Stream & Flowsight Amnis - combination of flow cytometry and image analysis



STANDARD COLLECTION SYSTEM

Image Channels: 1-6

OPTIONAL COLLECTION SYSTEM

Image Channels: 7-12

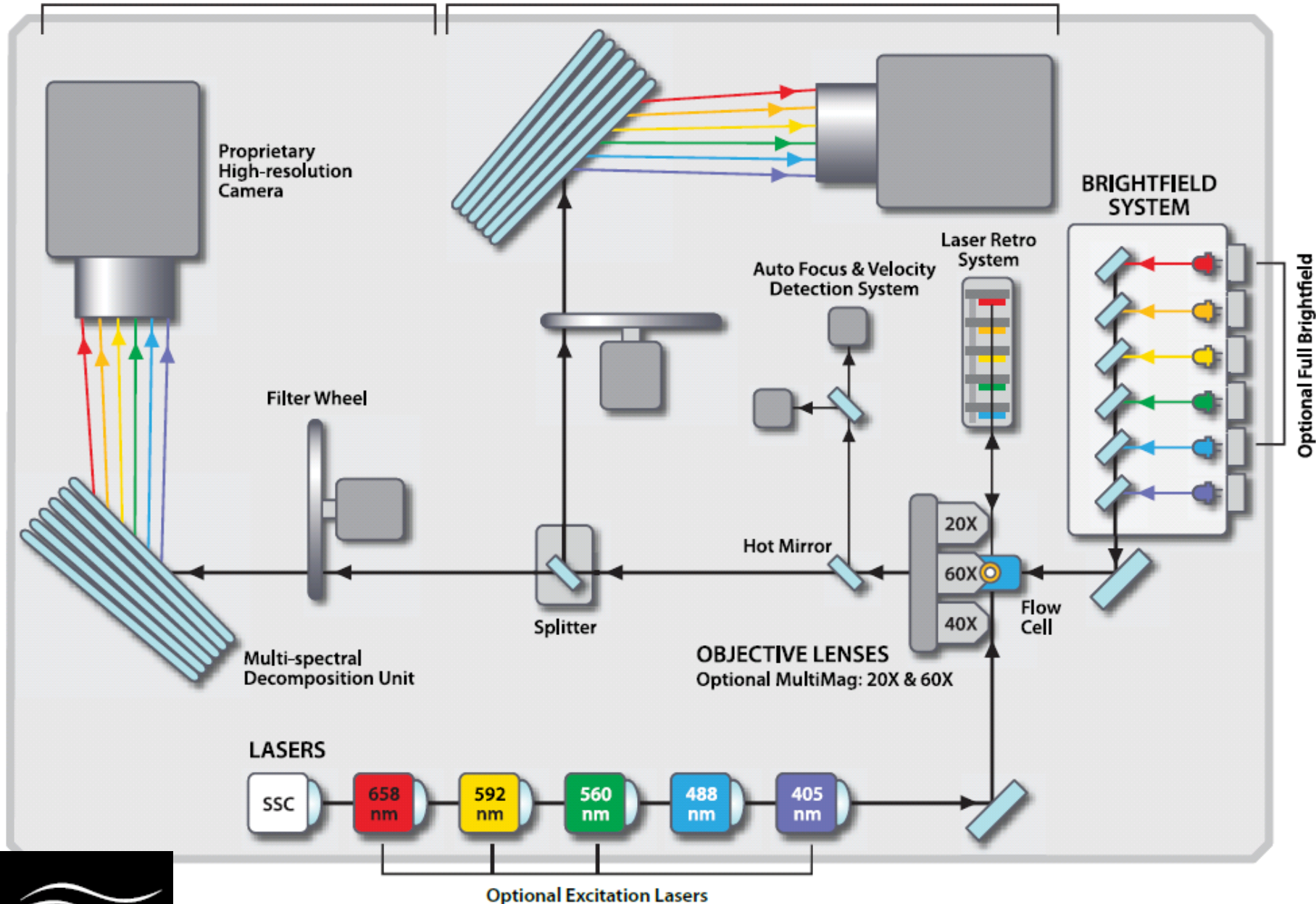

LASERS



Optional Excitation Lasers

Optional Full Brightfield



Amnis - applications

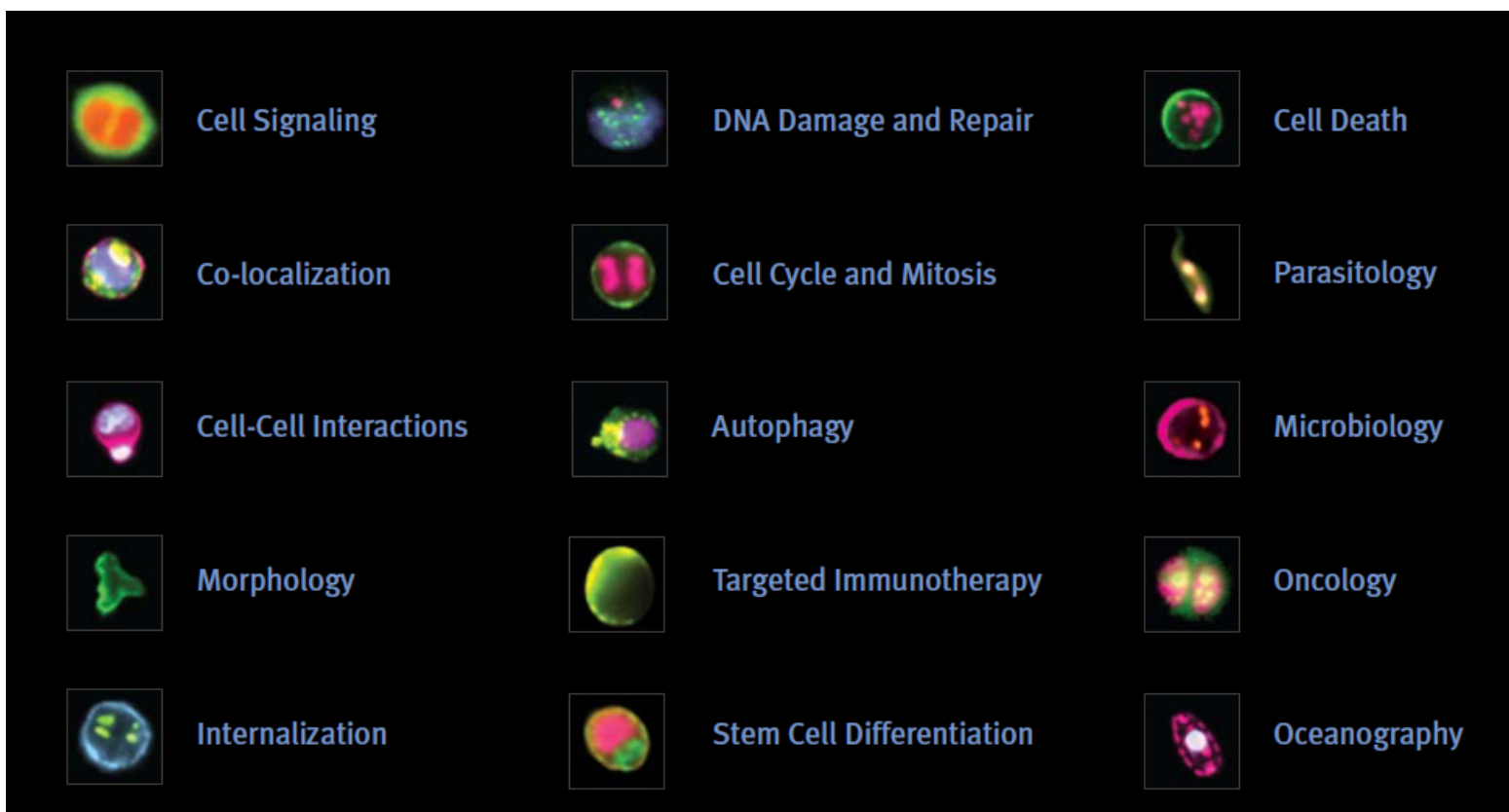

CellStream, Luminex

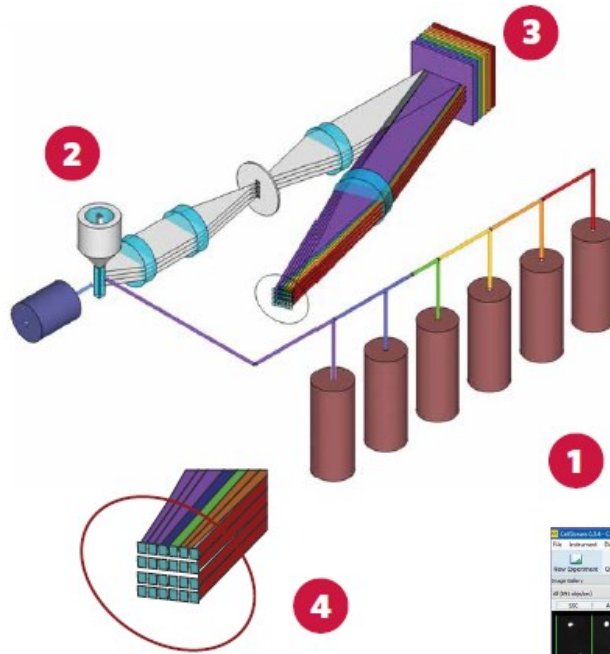

Inside the 7-Laser CellStream® System

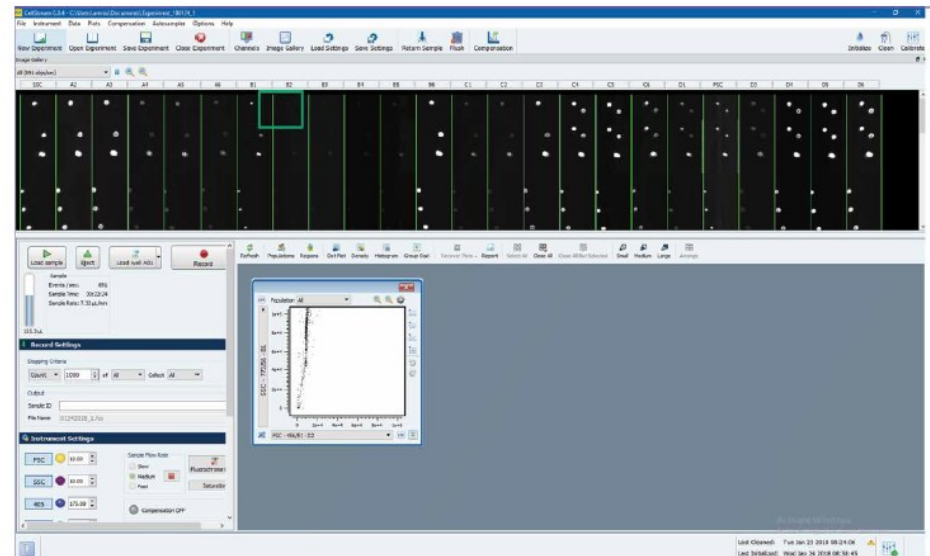

ThermoFisherScientific: Attune CytPix Flow Cytometer

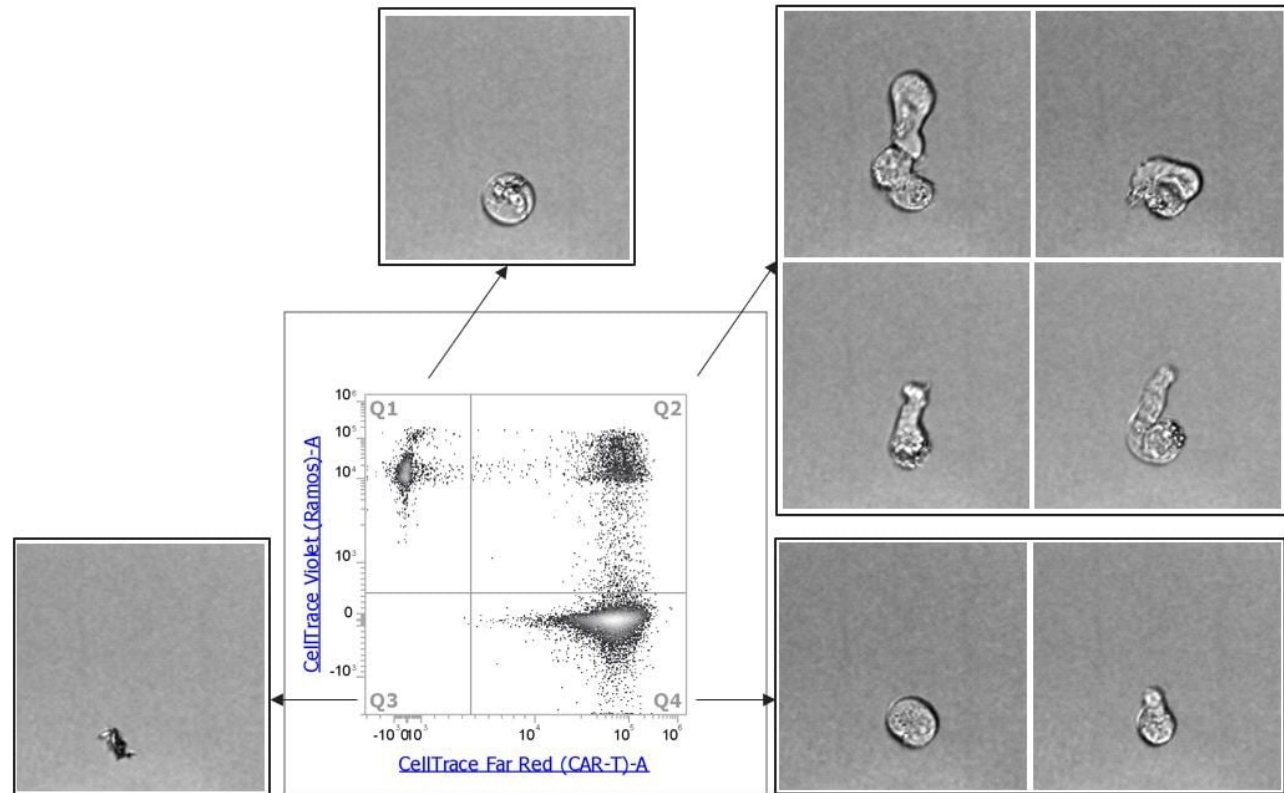

BD FACSDiscover S8

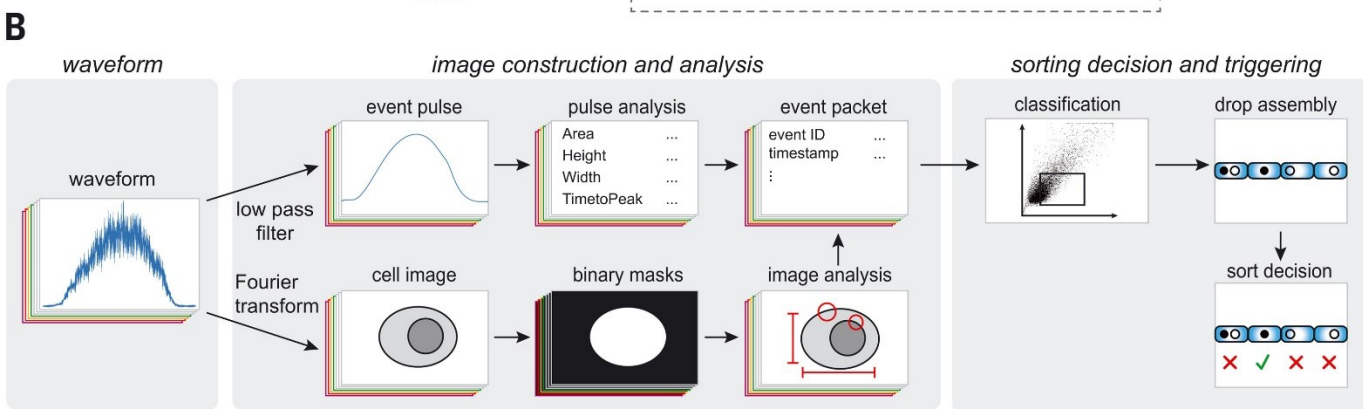
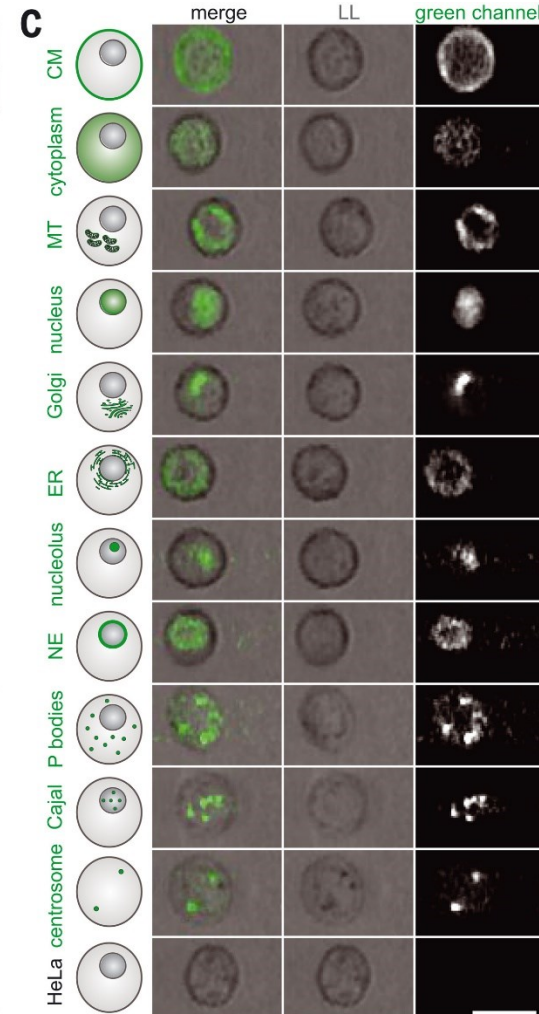
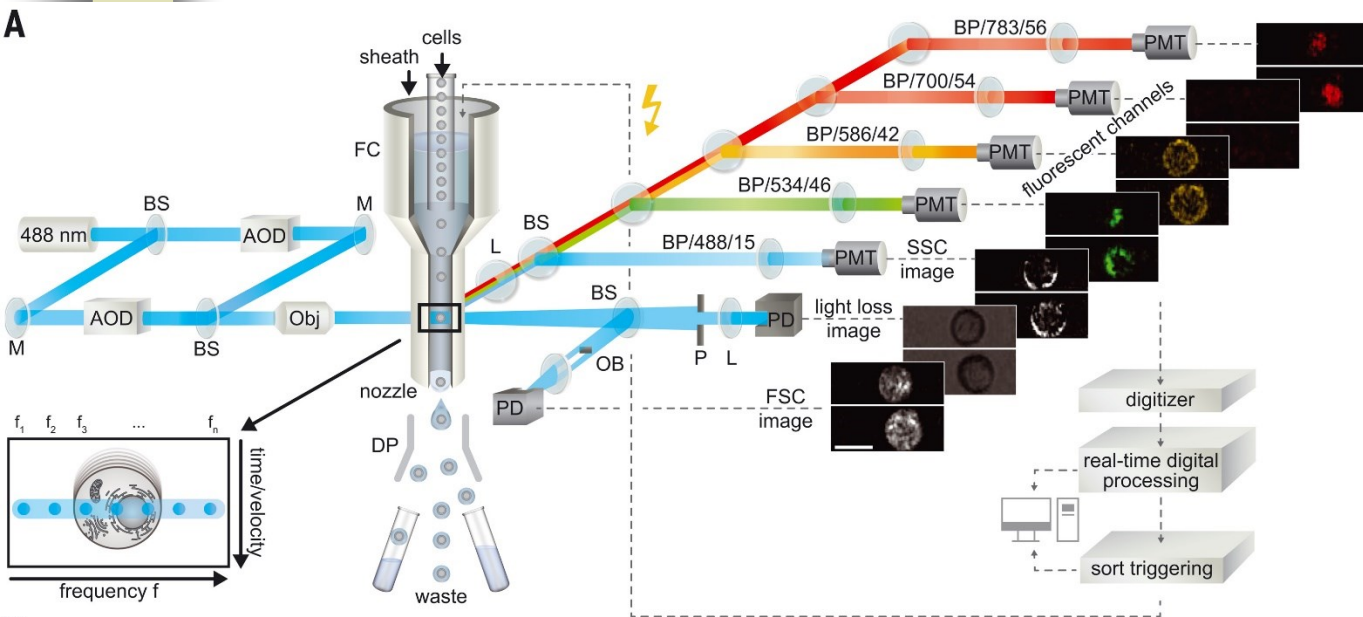

Octagon Detection System

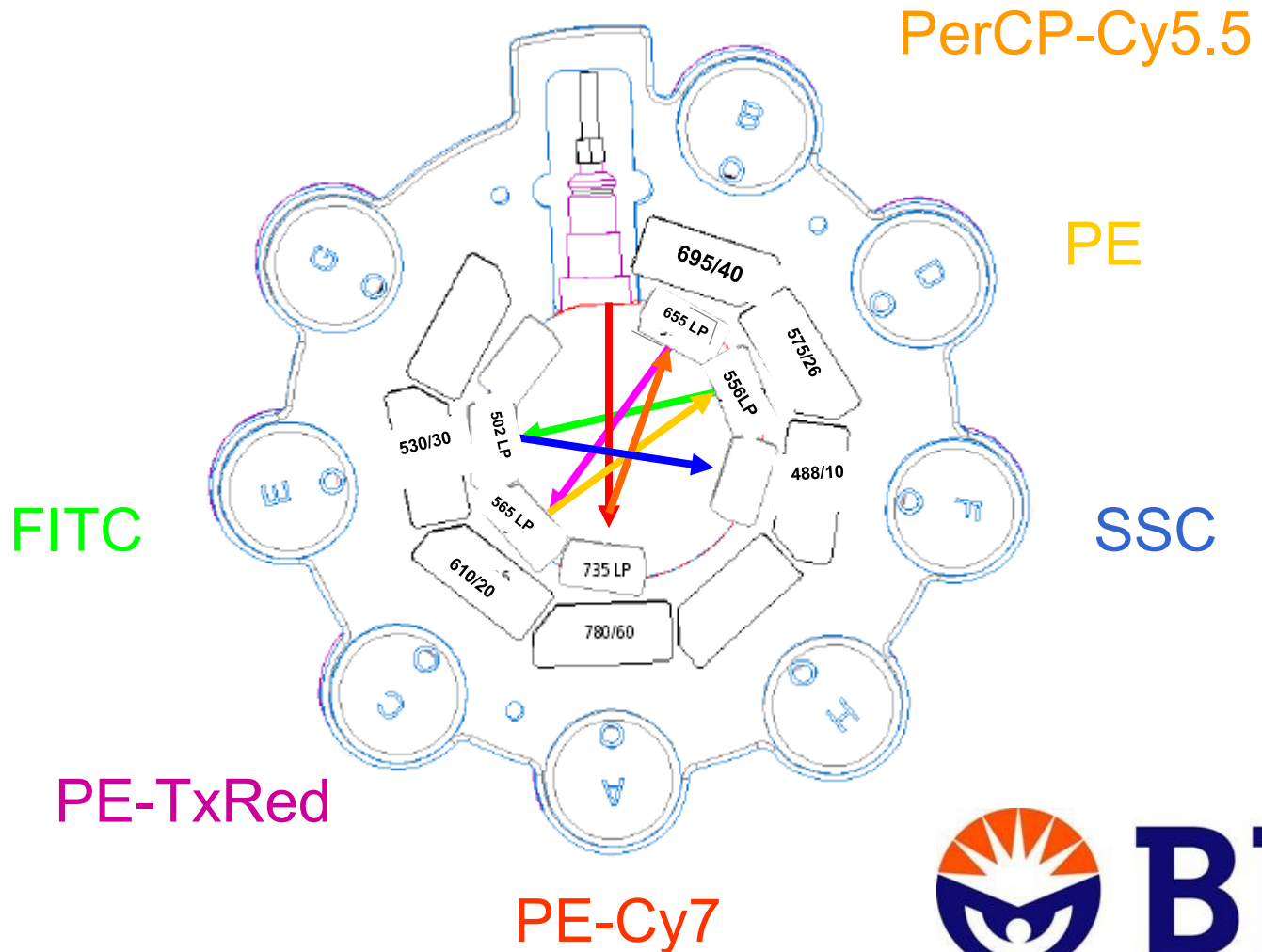

"cube" for conventional fluorescence microscope

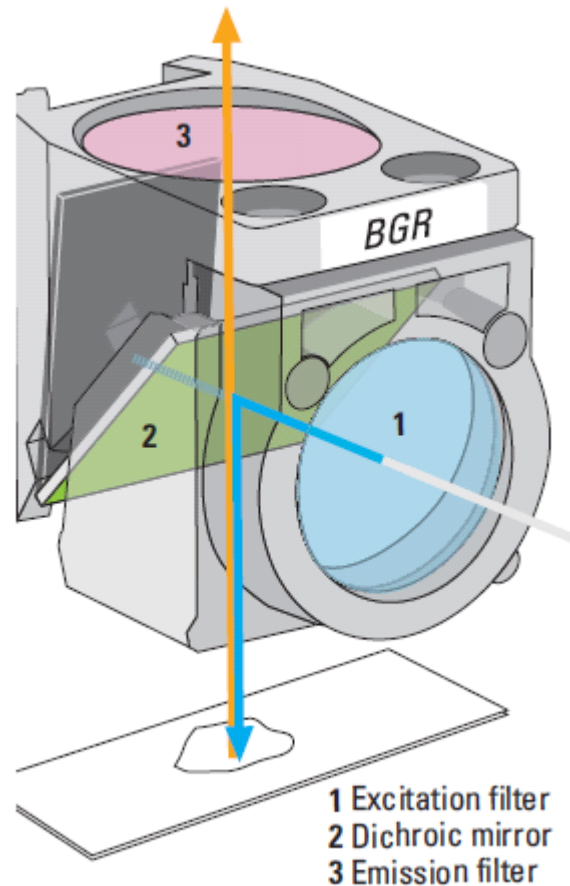

Acousto Optical Beam Splitter AOBS®

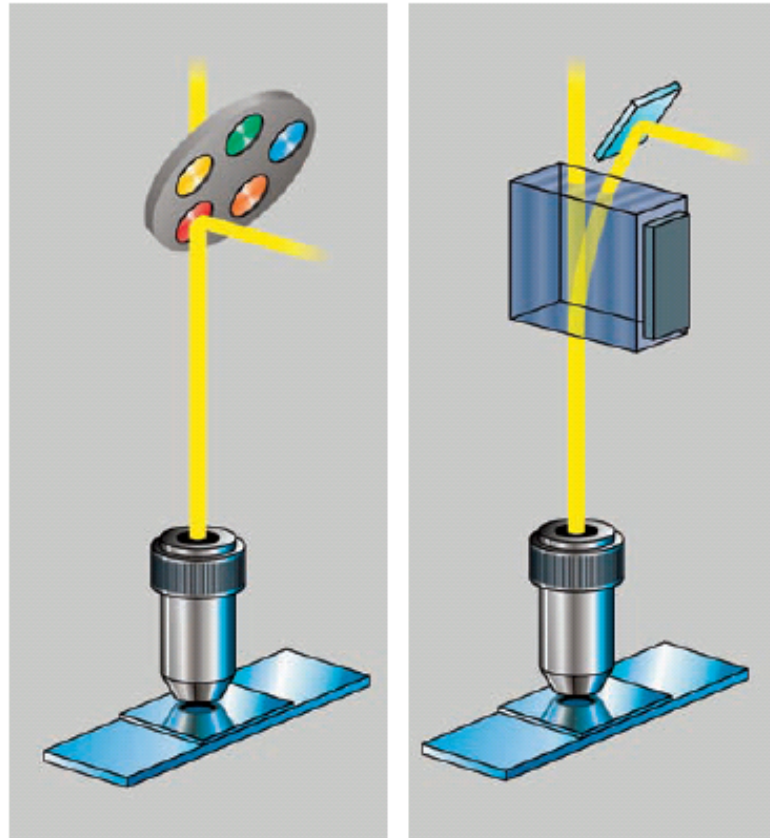

Left: conventional beam splitting by dichroic mirrors requires many optical elements with fixed properties.

Right: the AOBS® is electronically adaptable to all tasks.

Acousto Optical Beam Splitter AOBS®

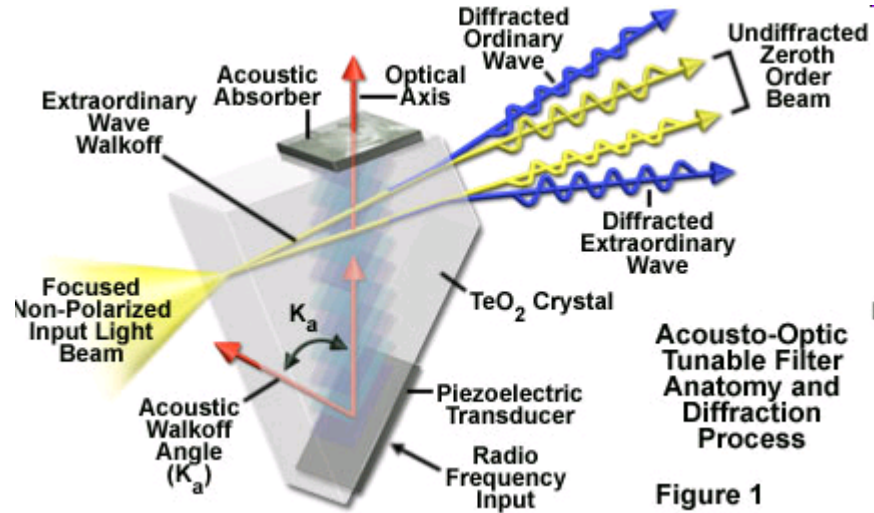

Acousto-Optic Tunable Filters in Confocal Microscopy

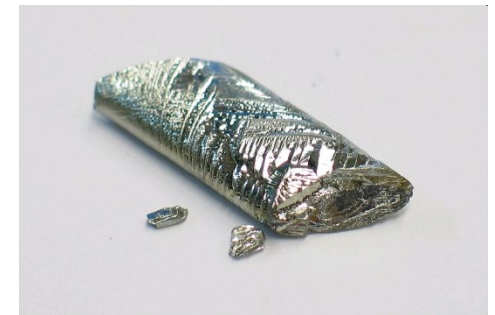
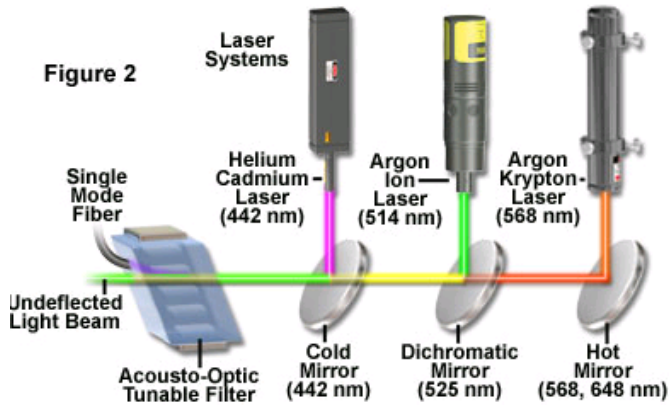

<http://micro.magnet.fsu.edu/primer/java/filters/aotf/index.html>

<http://simple.wikipedia.org/wiki/Tellurium>

Supercontinuum Generation

-a nonlinear process for strong spectral broadening of light

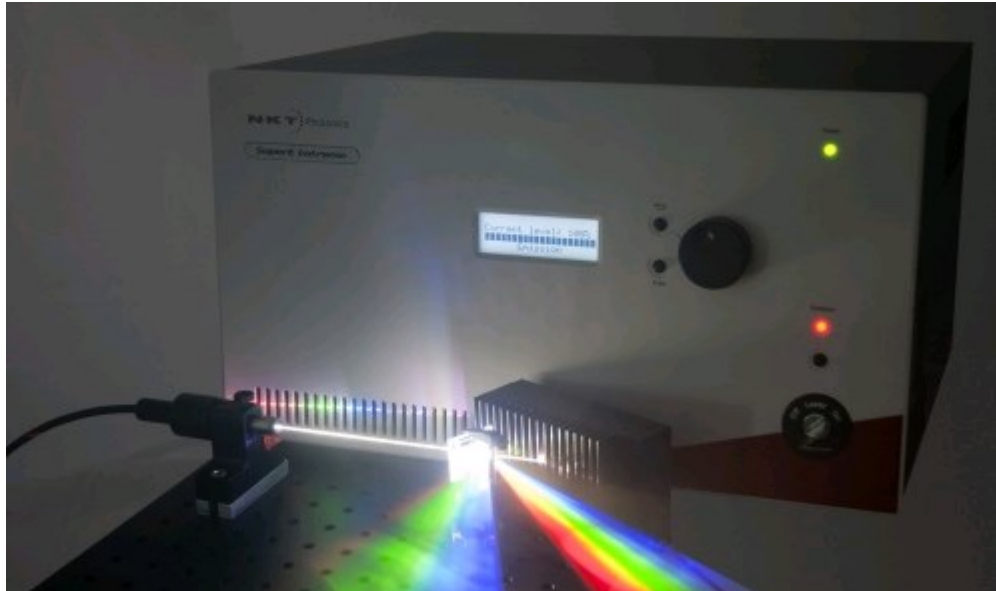

TECHNICAL NOTE

Cytometry

PART A
Journal of the
International Society for
Advancement of Cytometry

Supercontinuum White Light Lasers for Flow Cytometry

William G. Telford,^{1*} Fedor V. Subach,² Vladislav V. Verkhusha²

Cytometry Part A • 75A: 450–459, 2009

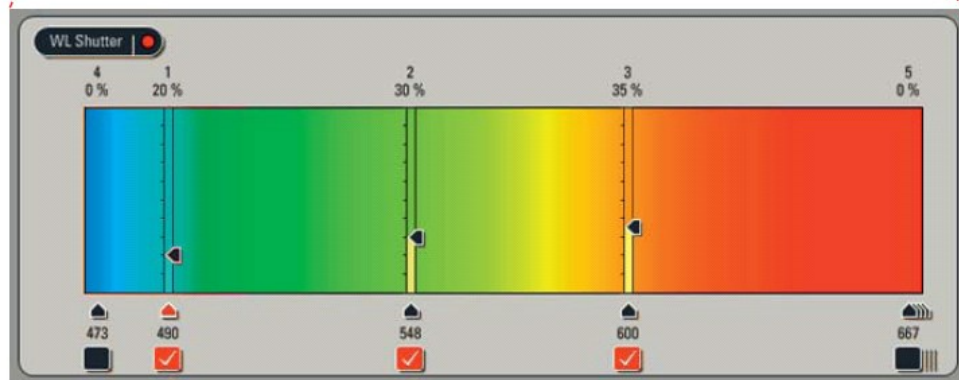
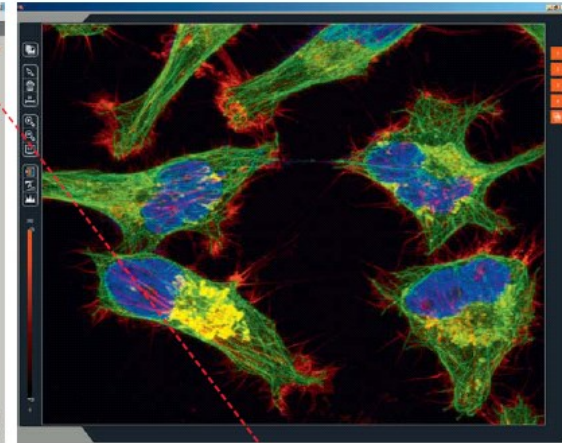
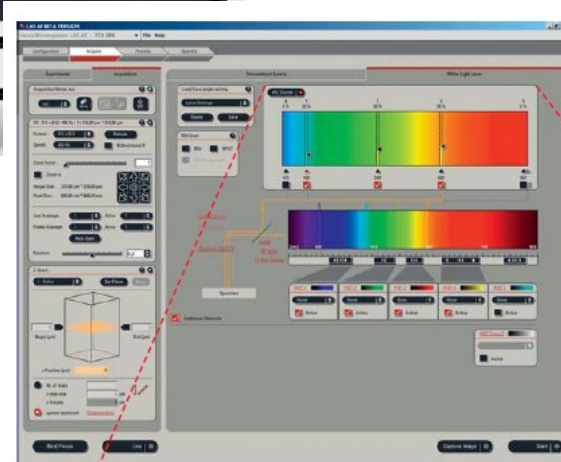

The benefits of AOBS®

- Adaptable to any new dye
- 8 lines simultaneously
- Reflected light imaging
- High transmission
- Truly confocal - real optical sectioning
- Fast switching
- Freely tunable
- Fluorescence correlation spectroscopy with multi-line lasers

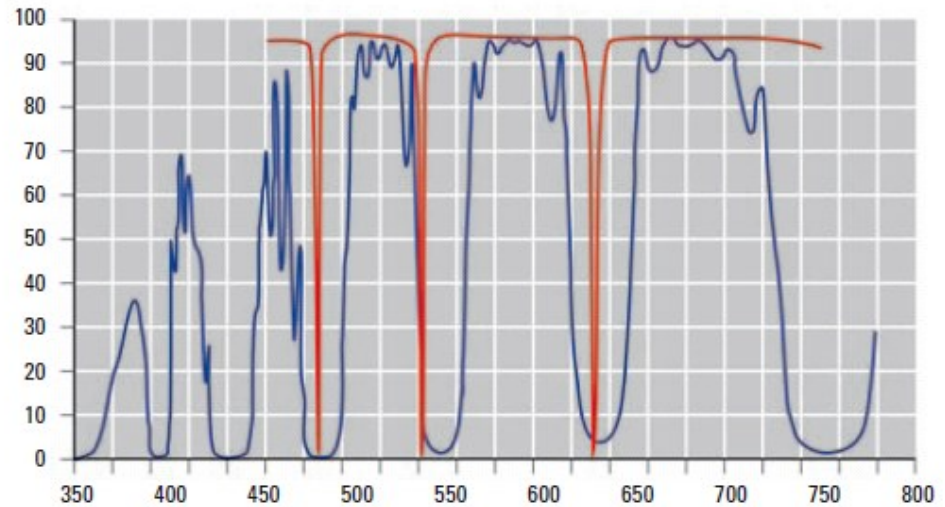

Transmission curves

Blue: triple dichroic, blue, green, red

Red: AOBS® tuned to 488, 543, 594, 633 nm

Higher transmission, wider bands and steeper slopes with AOBS®

Fluorescence Spectrum Viewers



<https://www.bdbiosciences.com/en-us/applications/research-applications/multicolor-flow-cytometry/product-selection-tools/spectrum-viewer>



<https://www.thermofisher.com/cz/en/home/life-science/cell-analysis/labeling-chemistry/fluorescence-spectraviewer.html>



<http://www.biolegend.com/panelselector>
<http://www.biolegend.com/spectraanalyzer>
<http://www.biolegend.com/webtoolstab>



<https://fluorofinder.com>

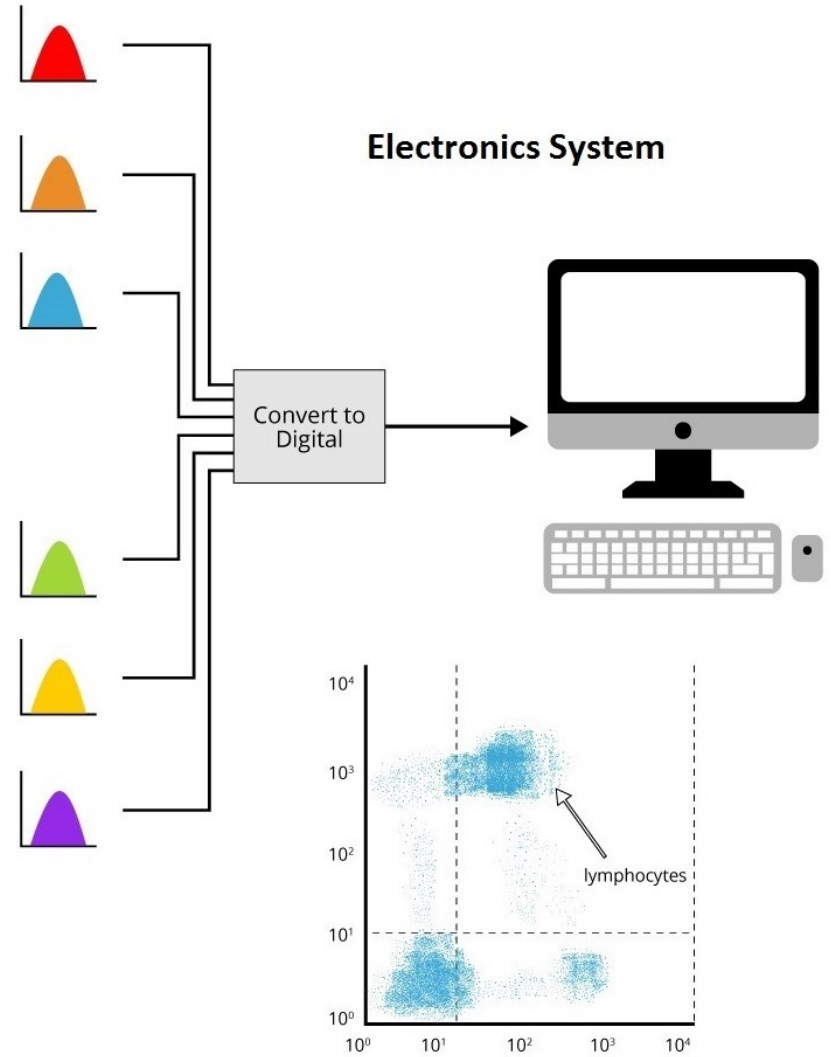
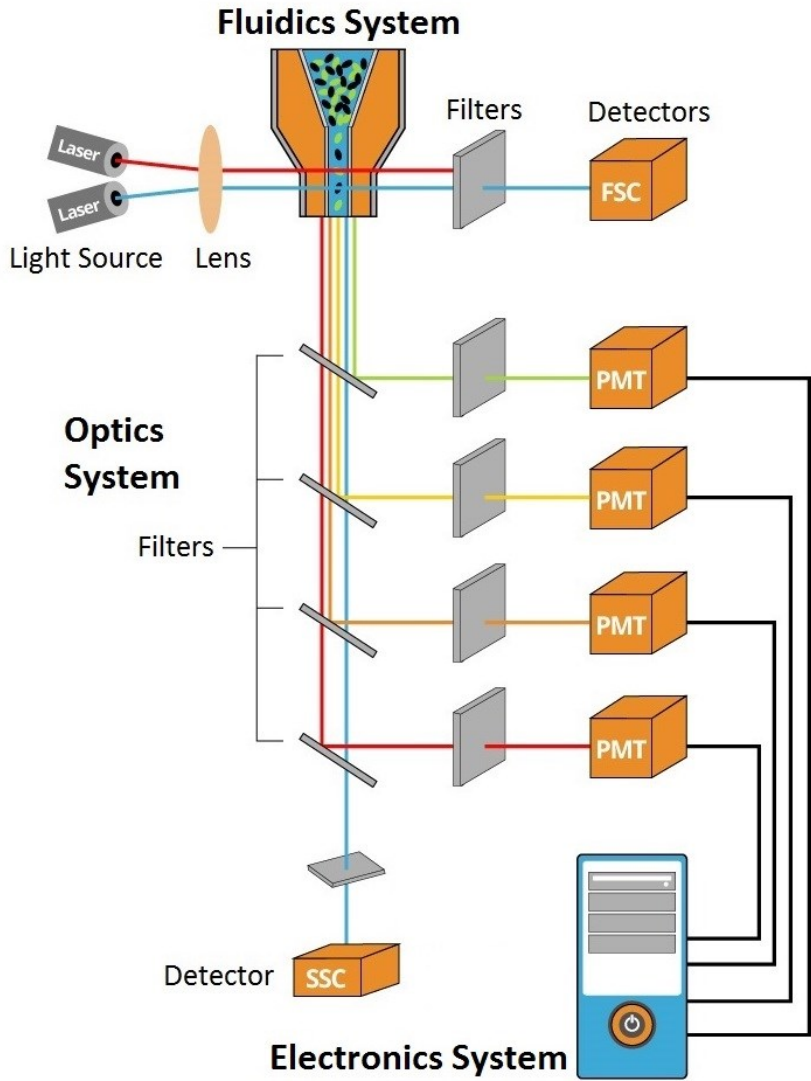



Fluidic systems and hydrodynamics

Getting the cells in the right place (at the right time)! (Shapiro, pp 133-143 - 3rd ed)

Fluid system : BD FACSAria II

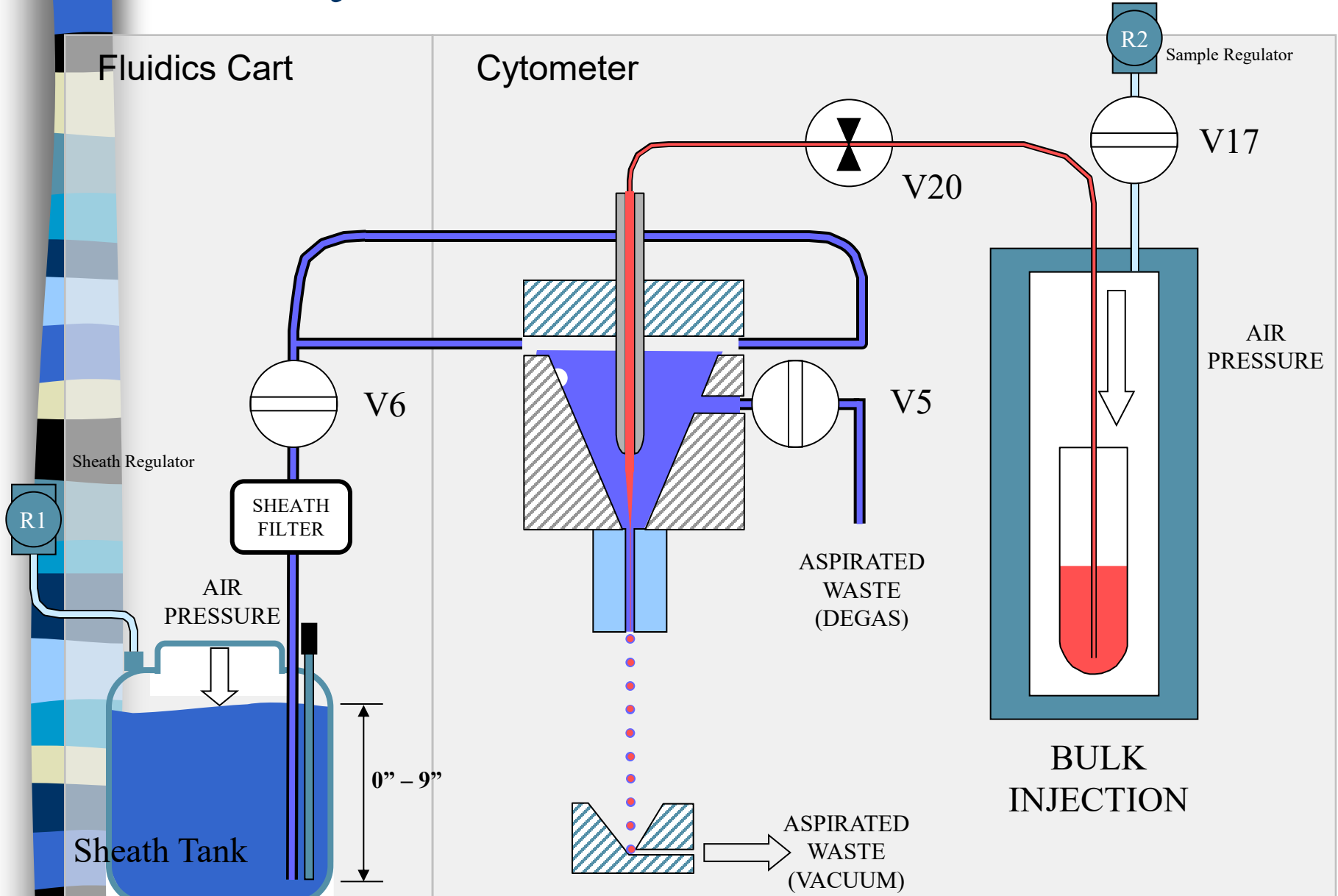

Hydrodynamic focusing in the cuvette

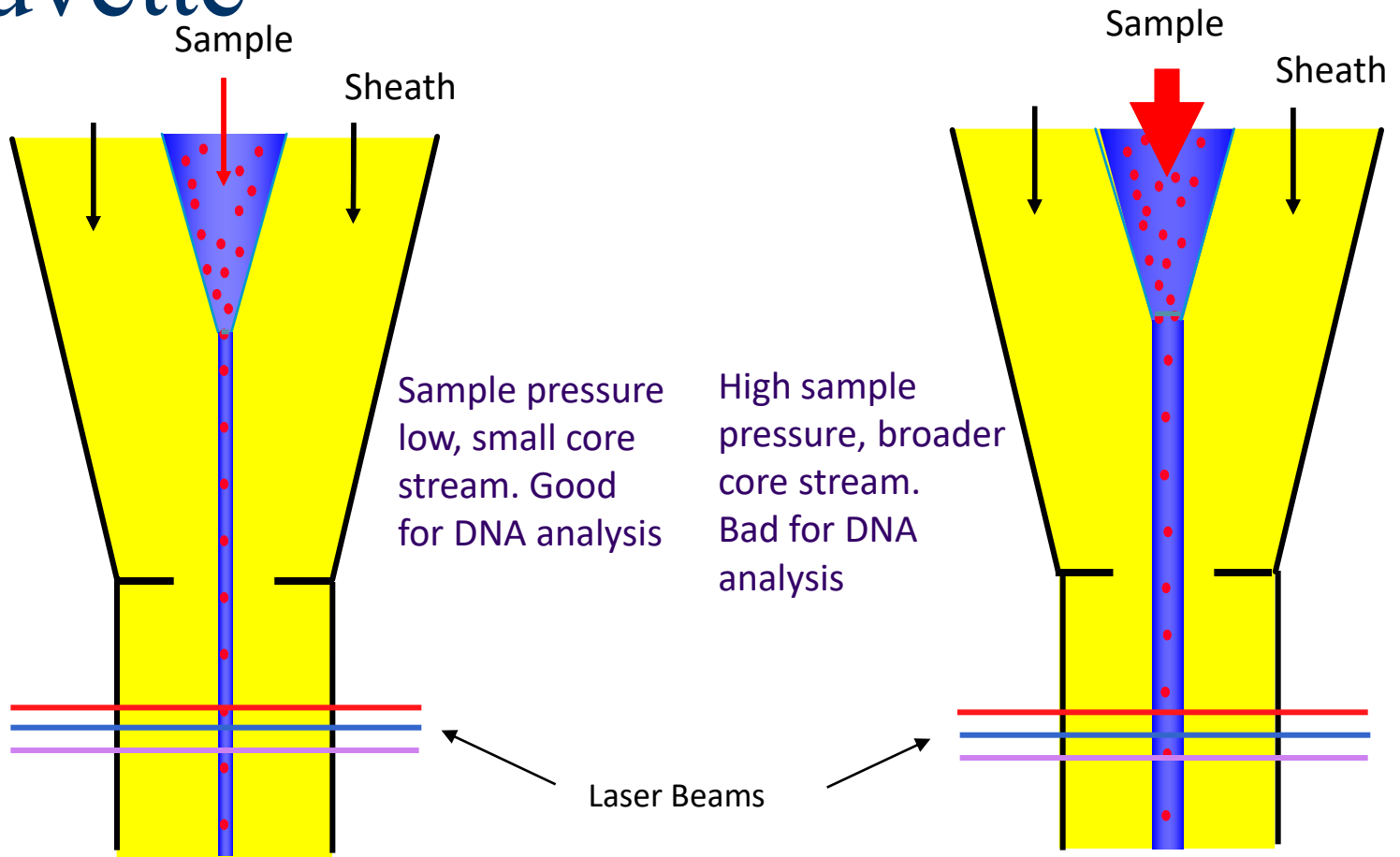

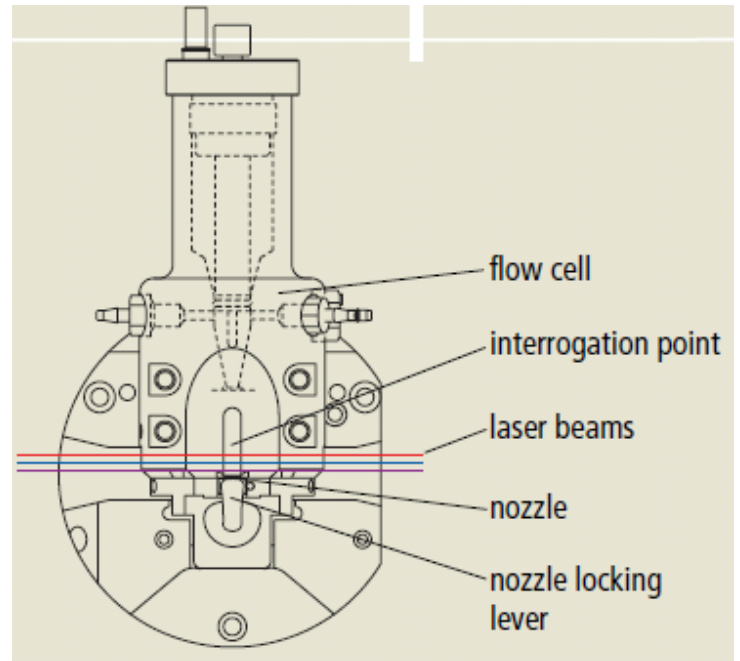
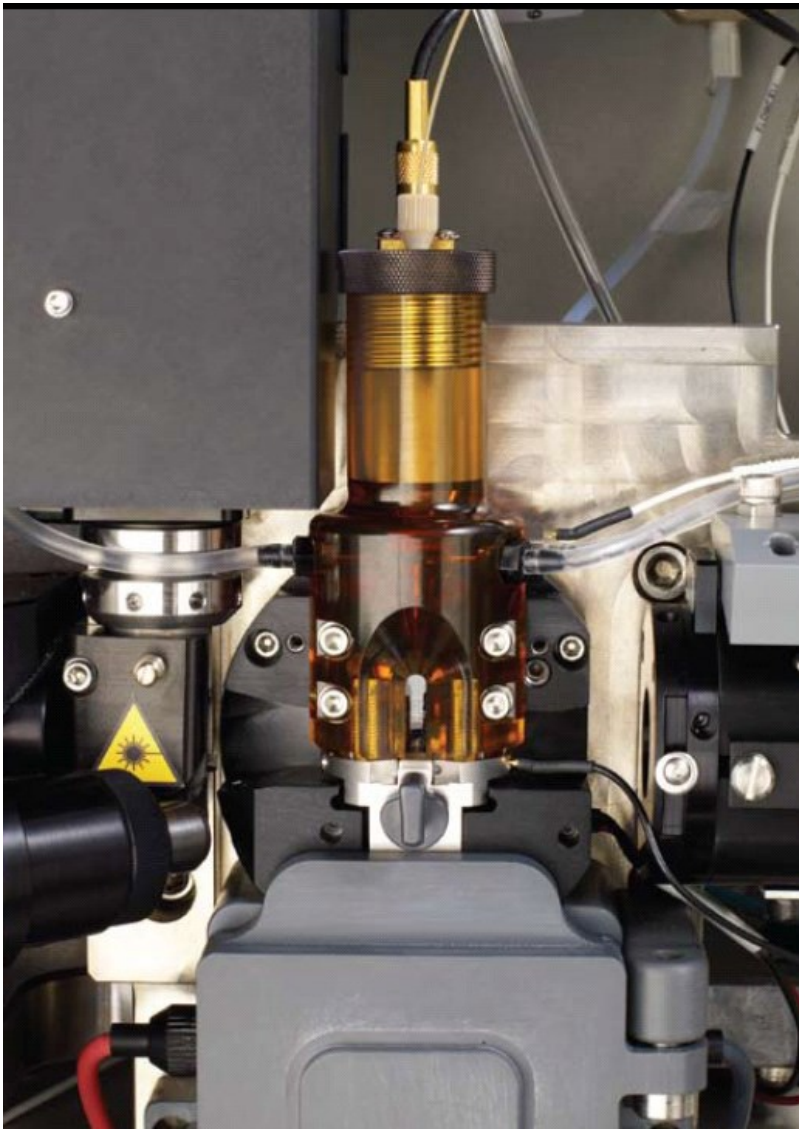

BD FACSaria II

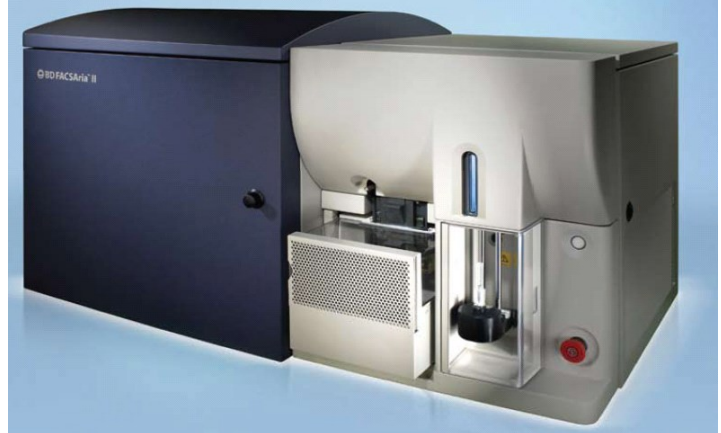



A



B



C



D

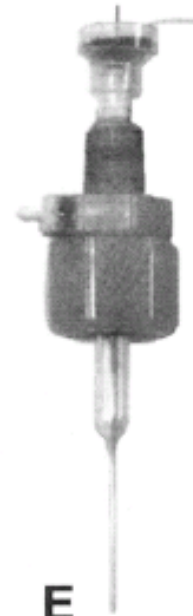

E

3 cm

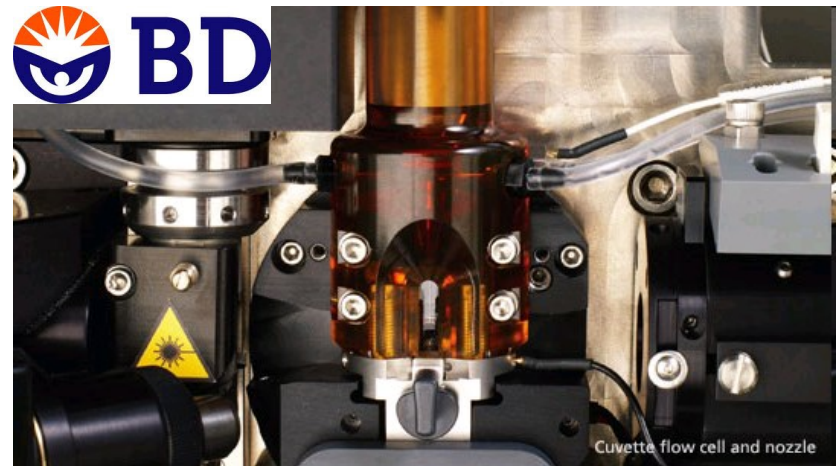
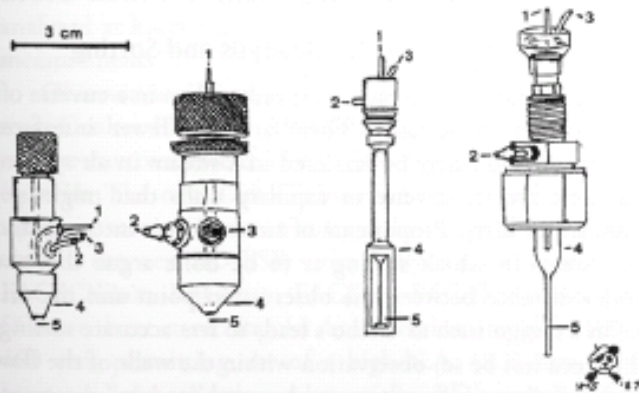

Cuvette flow cell and nozzle

Particle Delivery: Hydrodynamic Focusing

Conventional Instrumentation: **Low Flow Rates (12 μ L/min)**

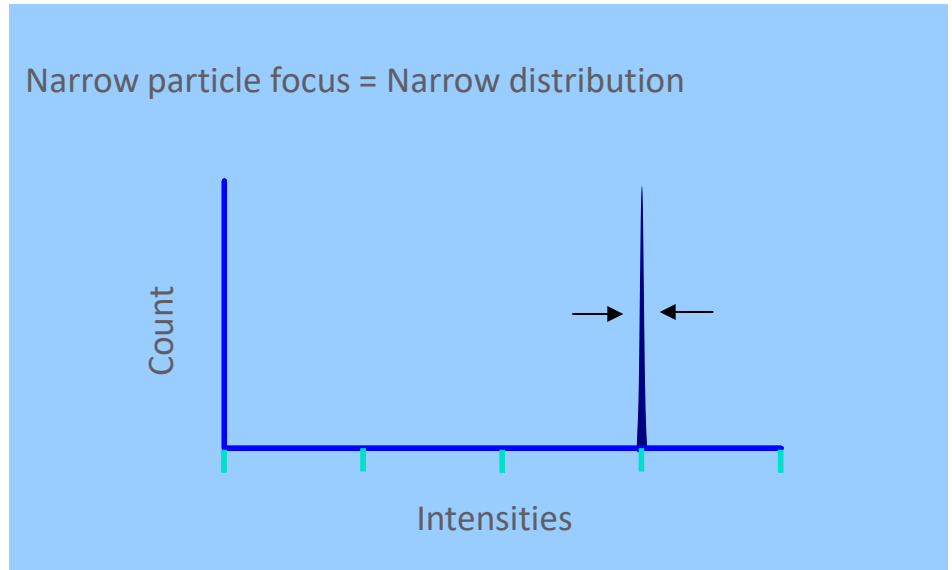
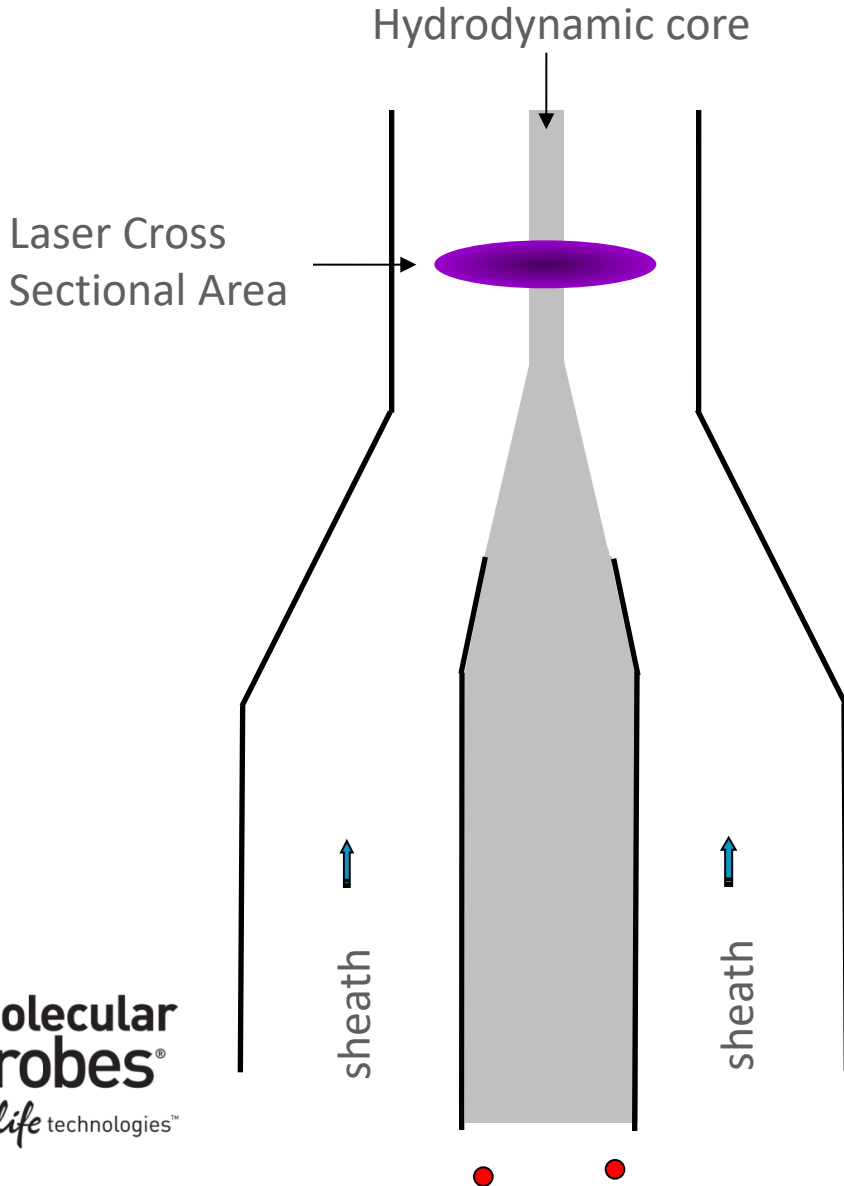

- Sample core is 'pinched' by fast flowing sheath
- Sample volume ratios of 100 – 1000
- Large ratios => low sample inputs
- Resolution of particle populations

Particle Delivery: Hydrodynamic Focusing

Conventional Instrumentation: **High Flow Rate (60 μ L/min)**

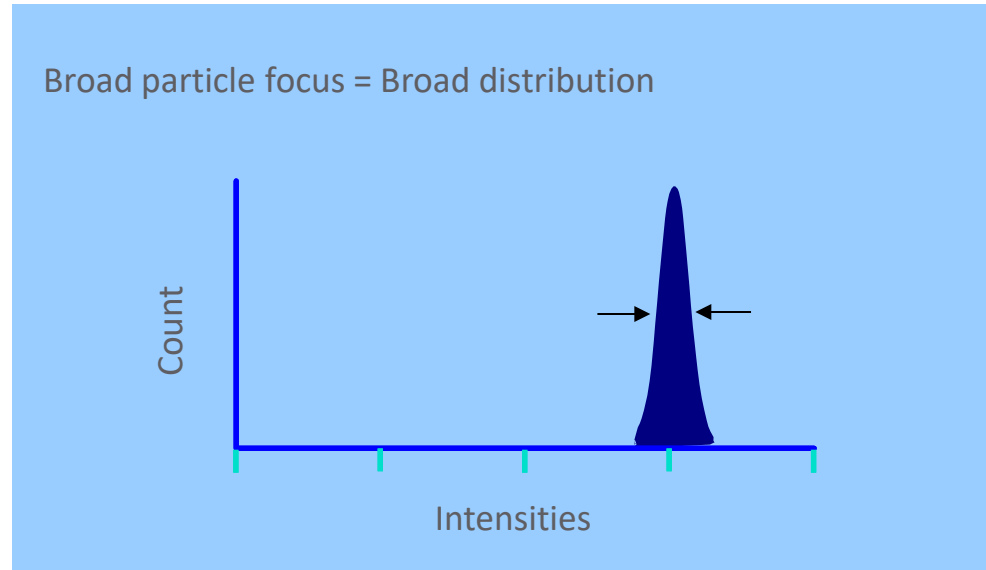
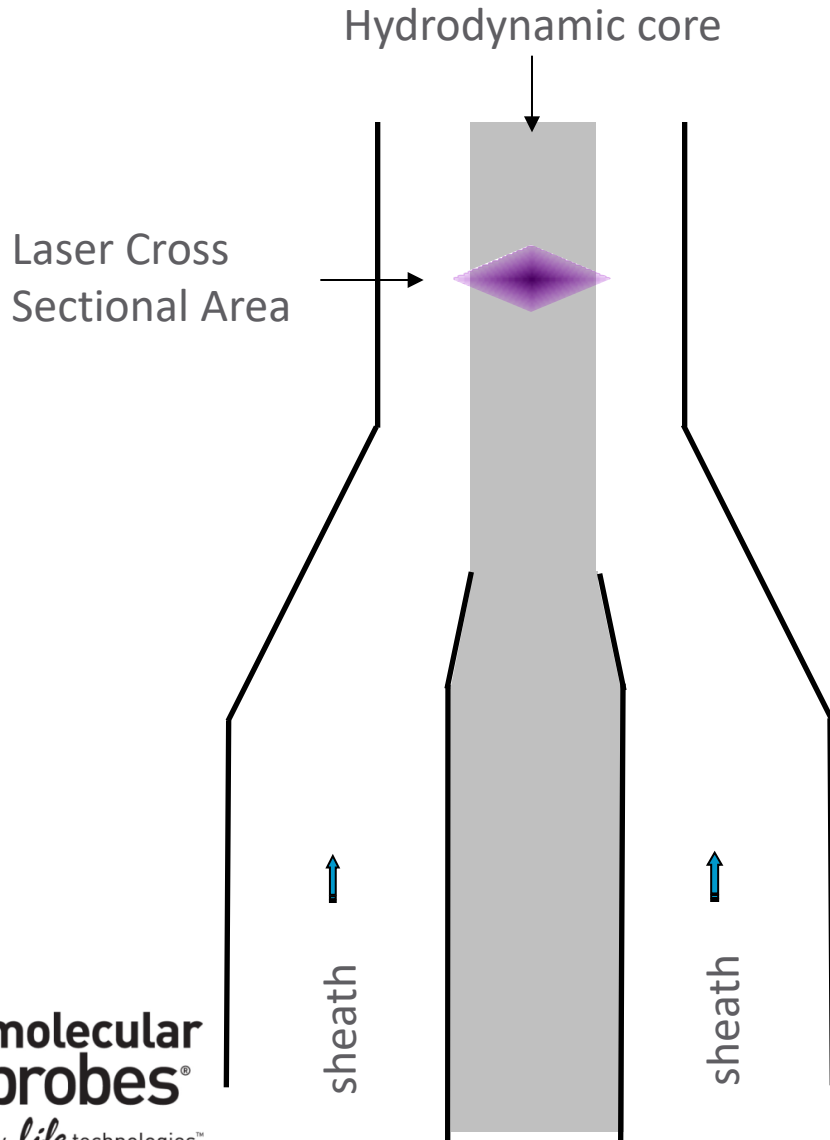

- Increased sample input = increased core size
- Particle distributions broadened, CVs increase
- Instrument resolution decreased
- Historically, low volumetric sample rates used (25 μ l/min – 150 μ l/min)

Attune® Acoustic Focusing Cytometer

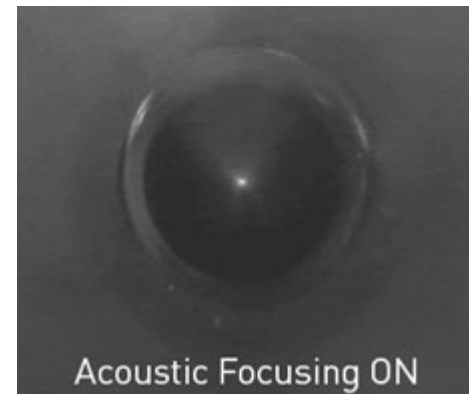
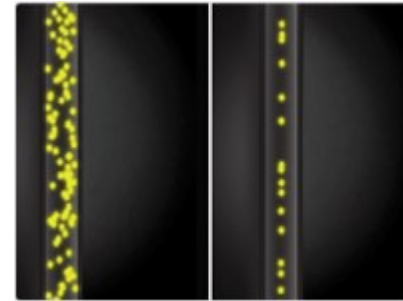
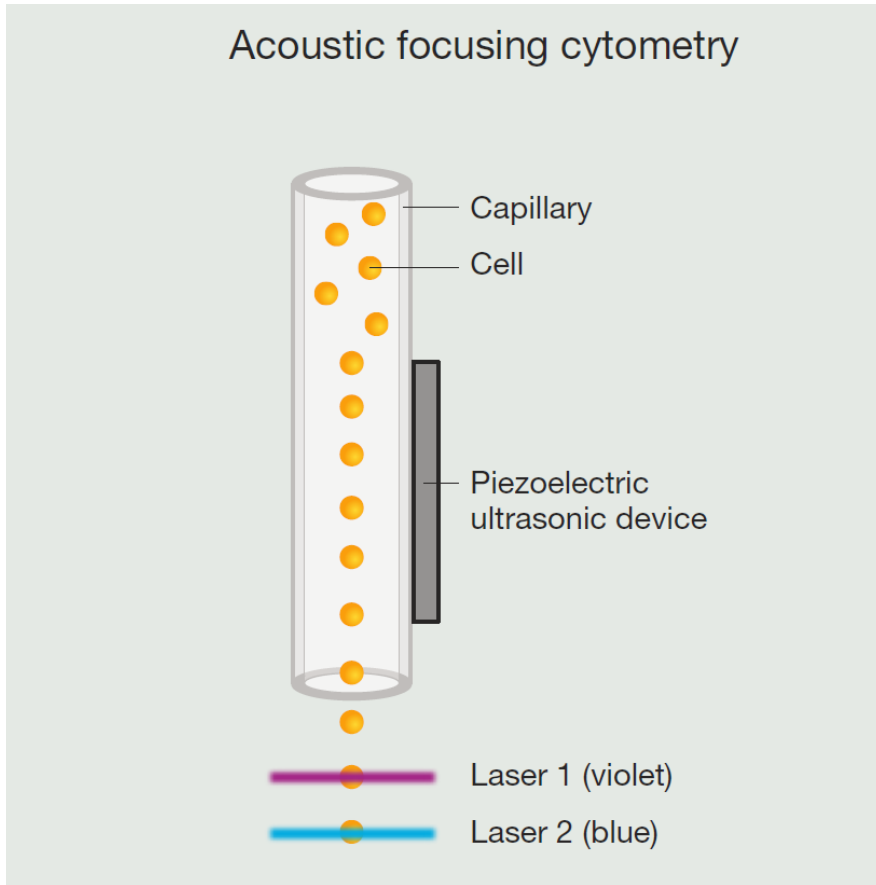

Acoustic Focusing = Better Precision

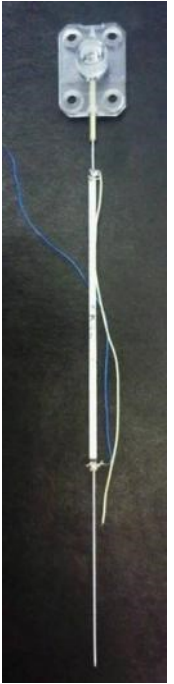
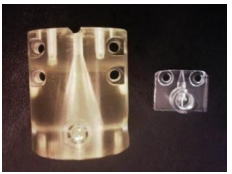
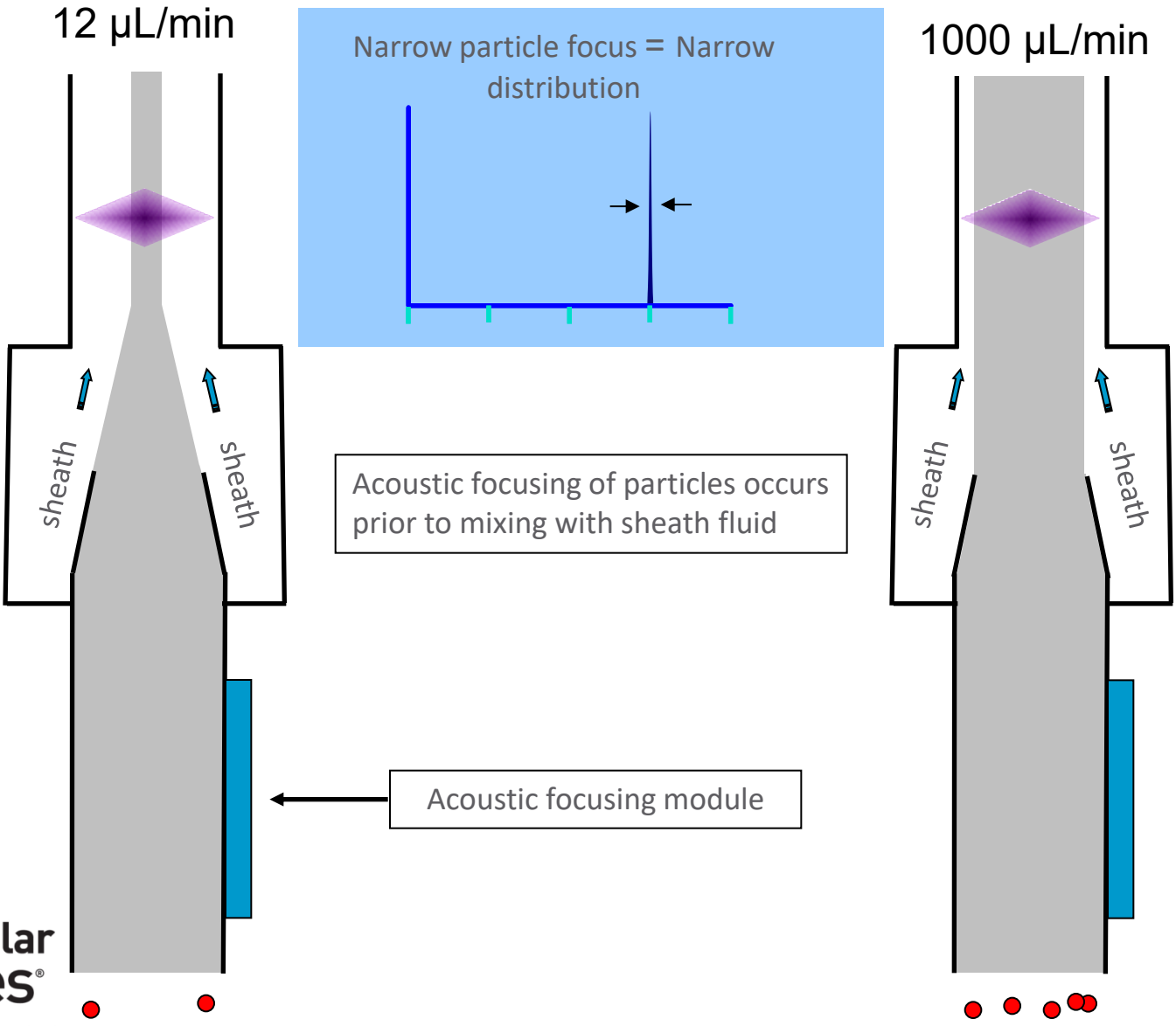

1. Kundt A, Lehmann O (1874) *Annalen der Physik und Chemie (Poggendorff's Annalen)* 153:1–11.
2. Curtis HW, Stephans EJ (1982) *IBM Technical Disclosure Bulletin* 25(1).
3. Yasuda K, Haupt SS, Umemura S (1997) *J Acoust Soc Am* 102:642–645.
4. Jonsson H, Nilsson A, Petersson F et al. (2005) *Perfusion* 20:39–43.
5. Kaduchak G, Goddard G, Salzman G et al. (2008) US Patent 7,340,957.

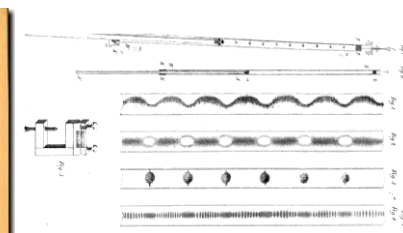

Using acoustic radiation force as a concentration method for erythrocytes

Kenji Yasuda,^{a)} Stephan Shuichi Haupt, and Shin-ichiro Umemura
Advanced Research Laboratory, Hitachi, Ltd., 2520 Akanuma, Hatoyama, Saitama 350-03, Japan

Toshiki Yagi
Zoological Institute, Faculty of Science, University of Tokyo, Hongo, Tokyo 113, Japan

Masaharu Nishida and Yasuhisa Shibata
Instrument Division, Hitachi, Ltd., 882 Ichige, Hitachinaka, Ibaraki 312, Japan

(Received 20 May 1996; accepted for publication 7 March 1997)

We investigated the potential damage inflicted on erythrocytes by acoustic radiation force when the cells are concentrated by a 500-kHz ultrasonic standing wave at the pressure node. The extent of the damage was estimated from the concentrations of potassium ions, iron complexes, and lactate dehydrogenase released from the cells. After 2 min of ultrasound irradiation at 12.8 mJ/m^3 , the cells concentrated on the pressure node, with a cell distribution half-width of $138 \mu\text{m}$; no significant release of intracellular components was detected, even after 15 min of irradiation. The results indicate that even small ions like potassium are not released as a result of ultrasound irradiation on cell membranes without cavitation, and they demonstrate the potential use of acoustic radiation force for concentrating living cells in biomedical applications. © 1997 Acoustical Society of America. [S0001-4966(97)01407-0]

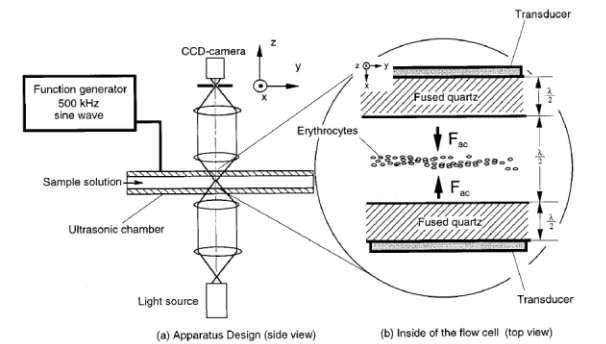
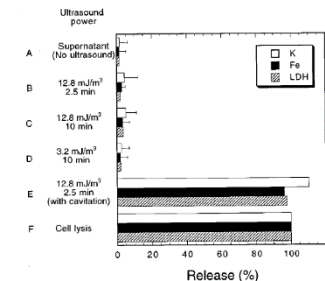
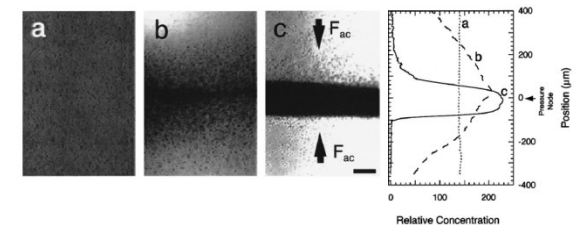

FIG. 1. Schematic diagram of the apparatus for concentration of erythrocytes.





US007340957B2

(12) **United States Patent**
Kaduchak et al.

(10) **Patent No.:** **US 7,340,957 B2**
(45) **Date of Patent:** **Mar. 11, 2008**

(54) **ULTRASONIC ANALYTE CONCENTRATION AND APPLICATION IN FLOW CYTOMETRY**

4,523,982 A *	6/1985	Lee	522/21
5,831,166 A *	11/1998	Kozuka et al.	73/570
6,003,388 A *	12/1999	Oeftering	73/864.01
6,216,538 B1 *	4/2001	Yasuda et al.	73/570.5
6,449,563 B1 *	9/2002	Dukhin et al.	702/22
2004/0139792 A1 *	7/2004	Cobb	73/61.75

(75) **Inventors:** **Gregory Kaduchak**, Los Alamos, NM (US); **Greg Goddard**, Los Alamos, NM (US); **Gary Salzman**, White Rock, NM (US); **Dipen Sinha**, Los Alamos, NM (US); **John C. Martin**, Los Alamos, NM (US); **Christopher Kwiatkowski**, Los Alamos, NM (US); **Steven Graves**, San Juan Pueblo, NM (US)

(73) **Assignee:** **Los Alamos National Security, LLC**, Los Alamos, NM (US)

(*) **Notice:** Subject to any disclaimer, the term of this patent is extended or adjusted under 35 U.S.C. 154(b) by 143 days.

(21) **Appl. No.:** **10/979,065**

(22) **Filed:** **Nov. 2, 2004**

FOREIGN PATENT DOCUMENTS

JP	63139231 A *	6/1988
JP	06241977 A *	9/1994
JP	08266891 A *	10/1996

OTHER PUBLICATIONS

King, L. V., "On the acoustic radiation on spheres," *Proc. R. Soc. A.*, 147, 212-240, (1933).

(Continued)

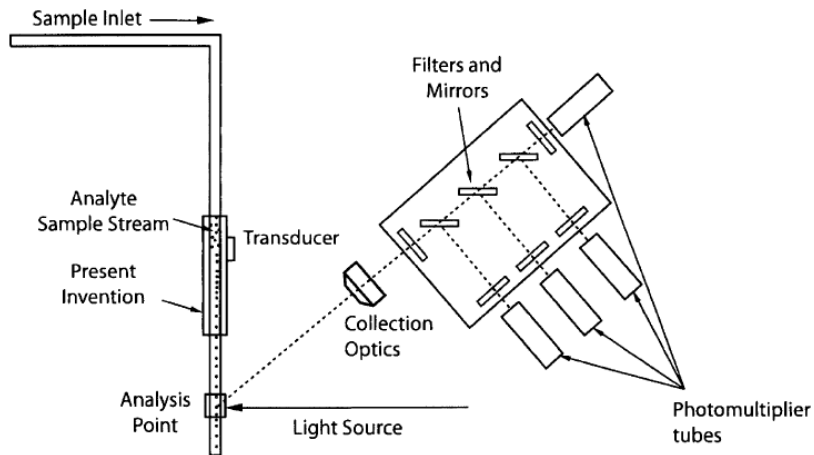
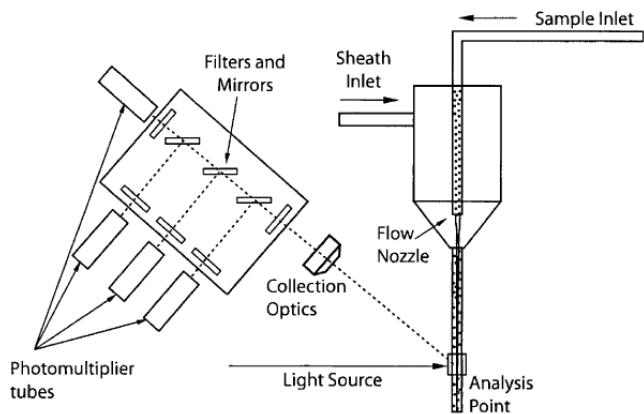
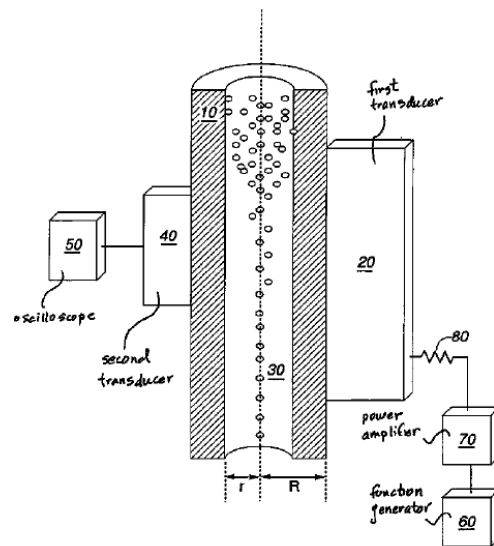

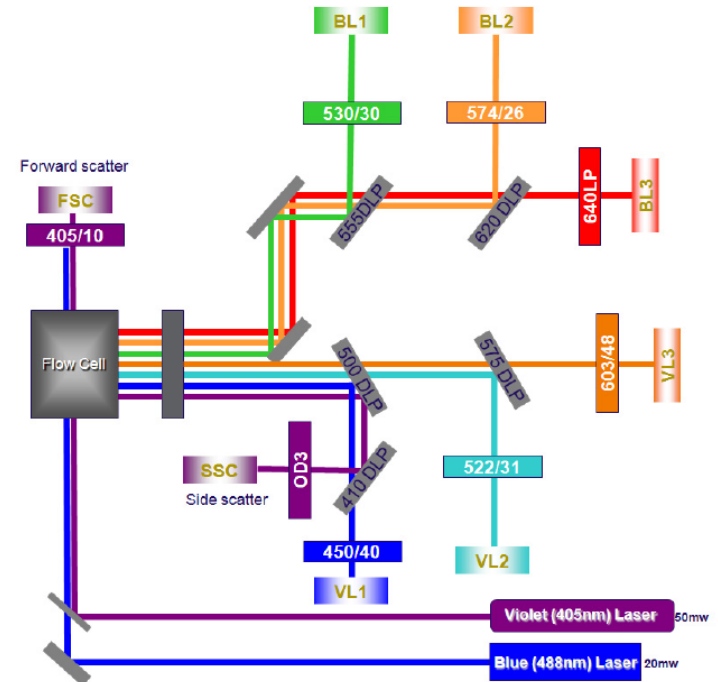
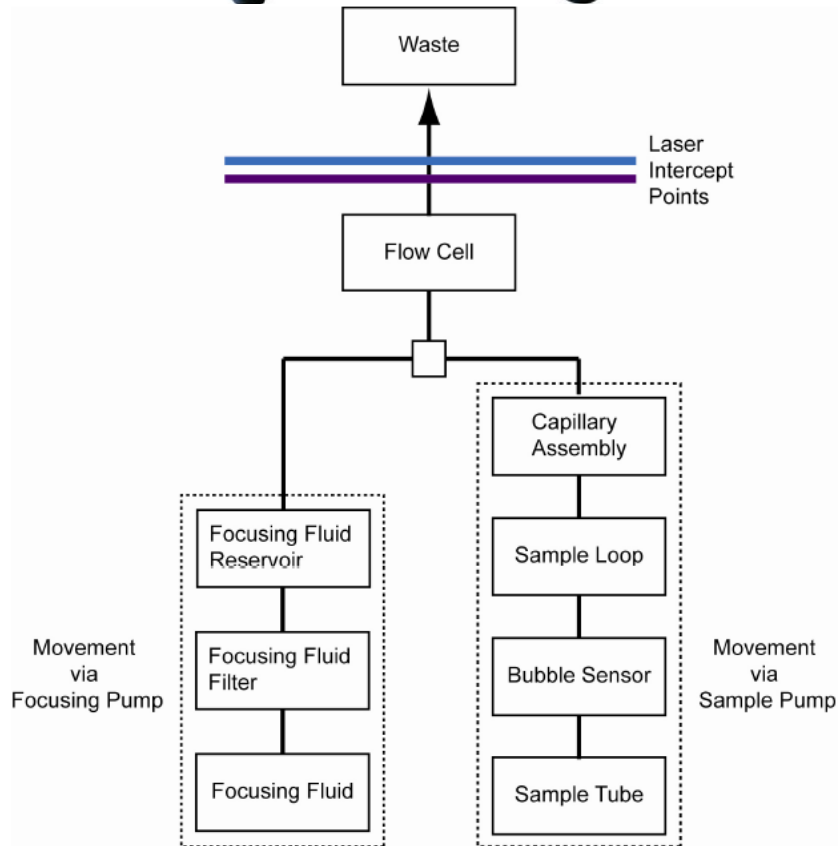

Attune NxT (2nd generation)

ThermoFisher
SCIENTIFIC



Lasers	Laser configuration (Cat. No.)	Violet 405 nm	Blue 488 nm	Yellow 561 nm	Green 532 nm	Red 637 nm	Total detection channels*
1	Blue (A24864)	Available as upgrade	4	Available as upgrade	Available as upgrade	Available as upgrade	6
2	Blue/green (A28995)	Available as upgrade	3	–	4	Available as upgrade	9
	Blue/yellow (A24861)	Available as upgrade	3	4	–	Available as upgrade	9
	Blue/violet (A24862)	4	4	Available as upgrade	Available as upgrade	Available as upgrade	10
	Blue/red (A24863)	Available as upgrade	4	Available as upgrade	Available as upgrade	3	9
3	Blue/green/red (A28997)	Available as upgrade	3	–	4	3	12
	Blue/green/violet (A28999)	4	3	–	4	Available as upgrade	13
	Blue/red/yellow (A28993)	Available as upgrade	3	4	–	3	12
	Blue/violet/yellow (A24859)	4	3	4	–	Available as upgrade	13
	Blue/red/violet (A24860)	4	4	Available as upgrade	Available as upgrade	3	13
4	Blue/red/violet/green (A29001)	4	3	–	4	3	16
	Blue/red/yellow/violet (A24858)	4	3	4	–	3	16

* Includes forward scatter (FSC) and side scatter (SSC).

Attune® Throughput Compared to Hydrodynamic Focused Instruments

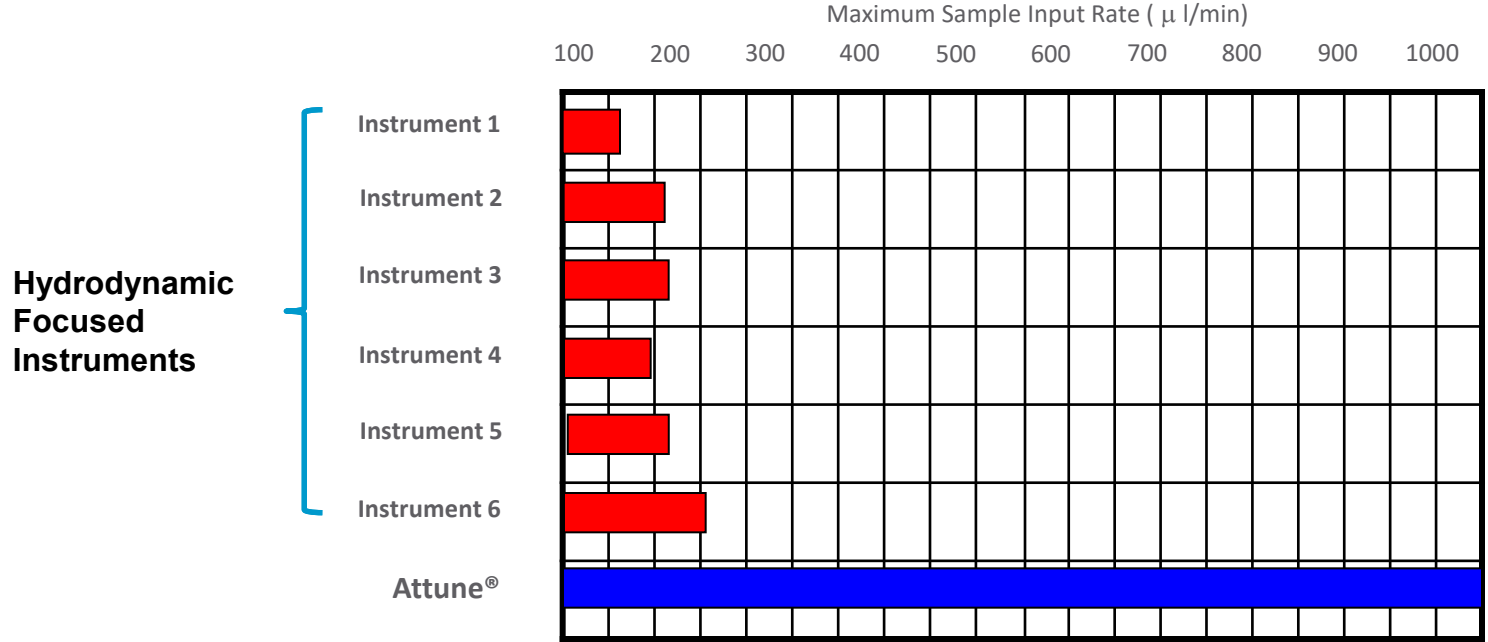

- Attune® can analyze at sample rates from 25μL/min to 1000μL/min without losing accuracy
- Traditional Flow Cytometers can only run at most 150μL/min and will sacrifice data quality
- Higher sample rates enable dilution of limited samples and analysis of Rare Events Faster



Fluidics – summary

- the pressure of the carrier (sheathing) liquid drives the buffer through the cuvette and the higher pressure in the sample tube introduces the sample into the cuvette.
- The principle of hydrodynamic focusing aligns the cells in the cuvette "like pearls on a string" before they reach the point where the laser beam intersects.
- Hydrodynamic focusing cannot dissociate cell aggregates. Flow cytometry requires a suspension of single cells!



Principles of flow cytometry and sorting

- sorting

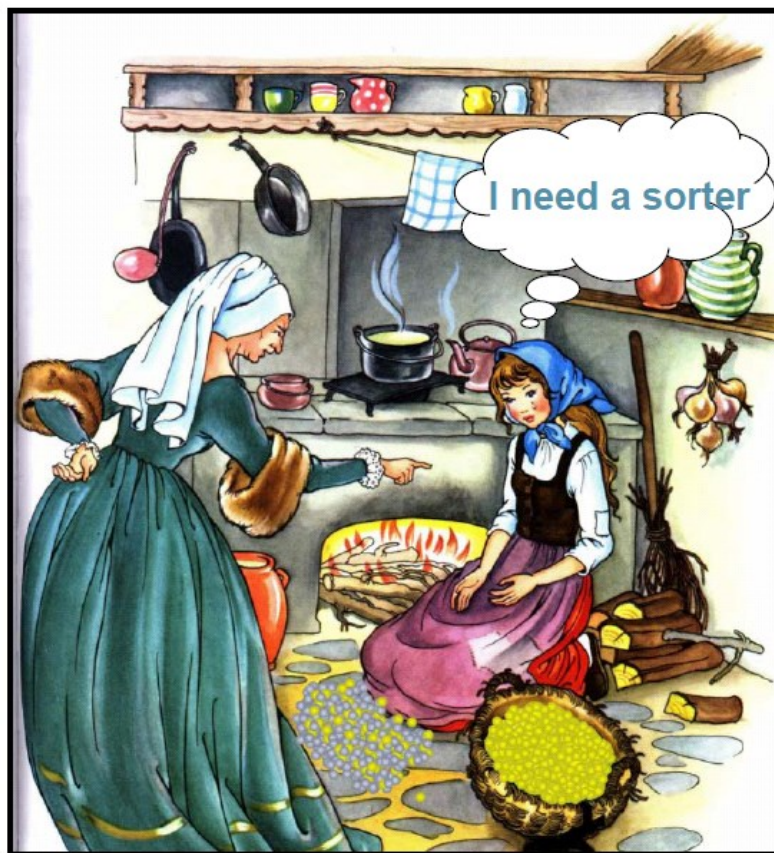

Doležel (1999)



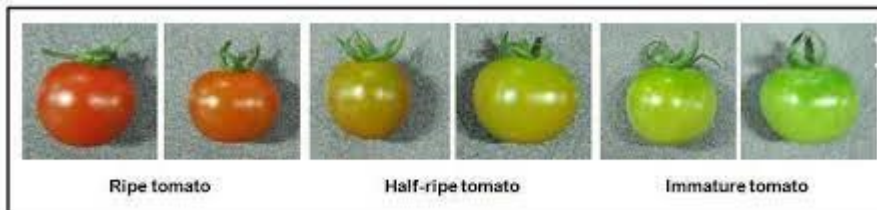
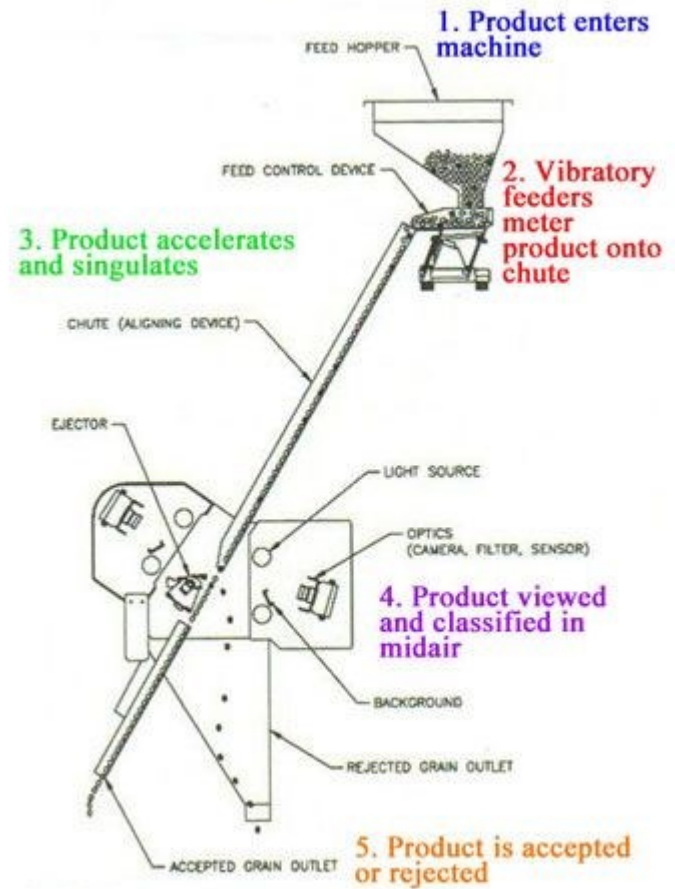
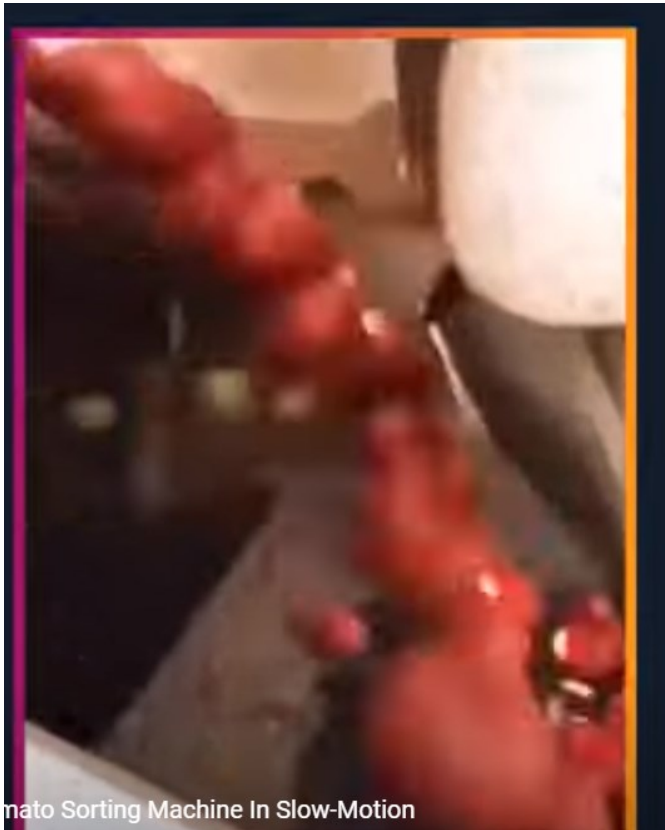

SORTING

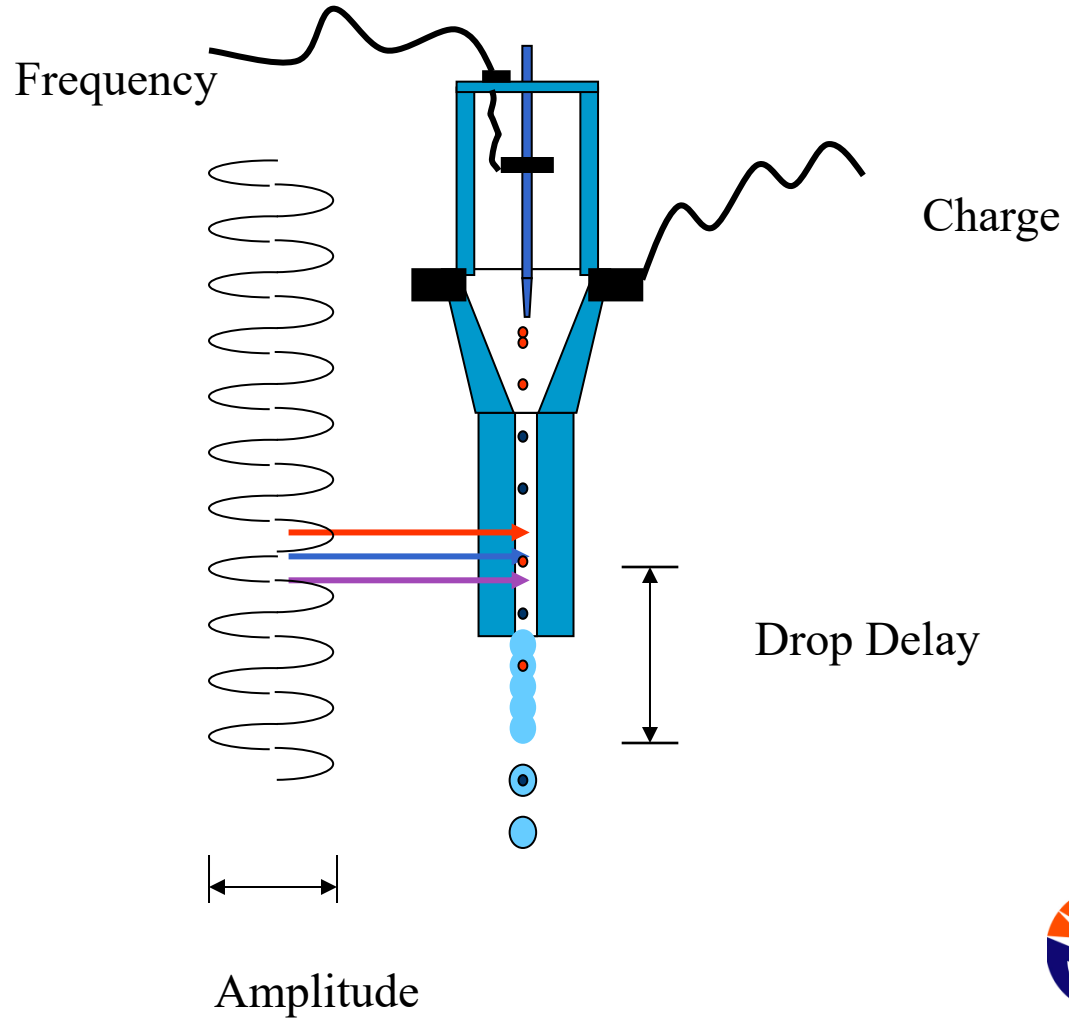

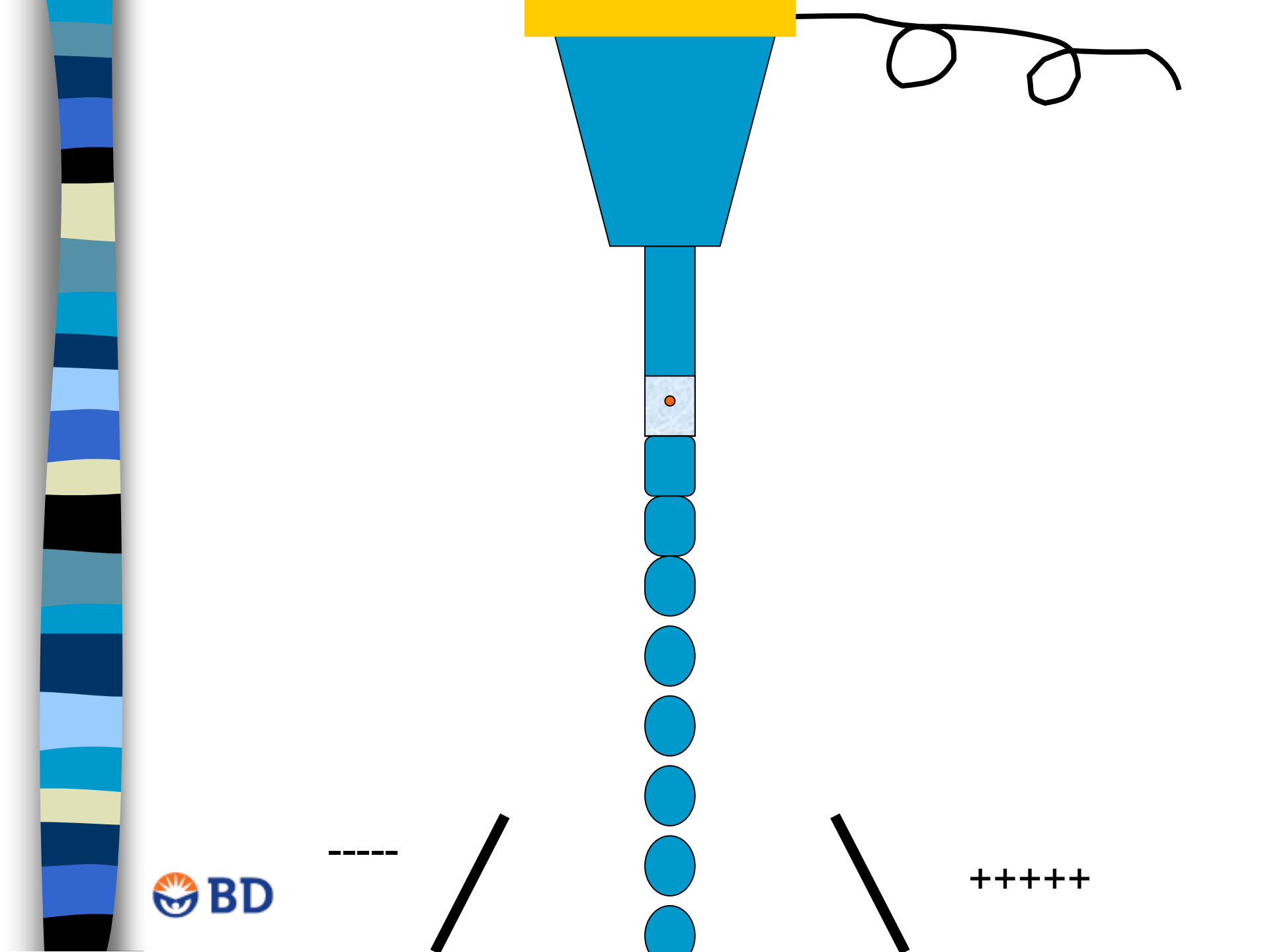

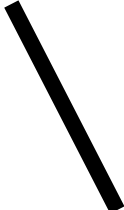

+++++

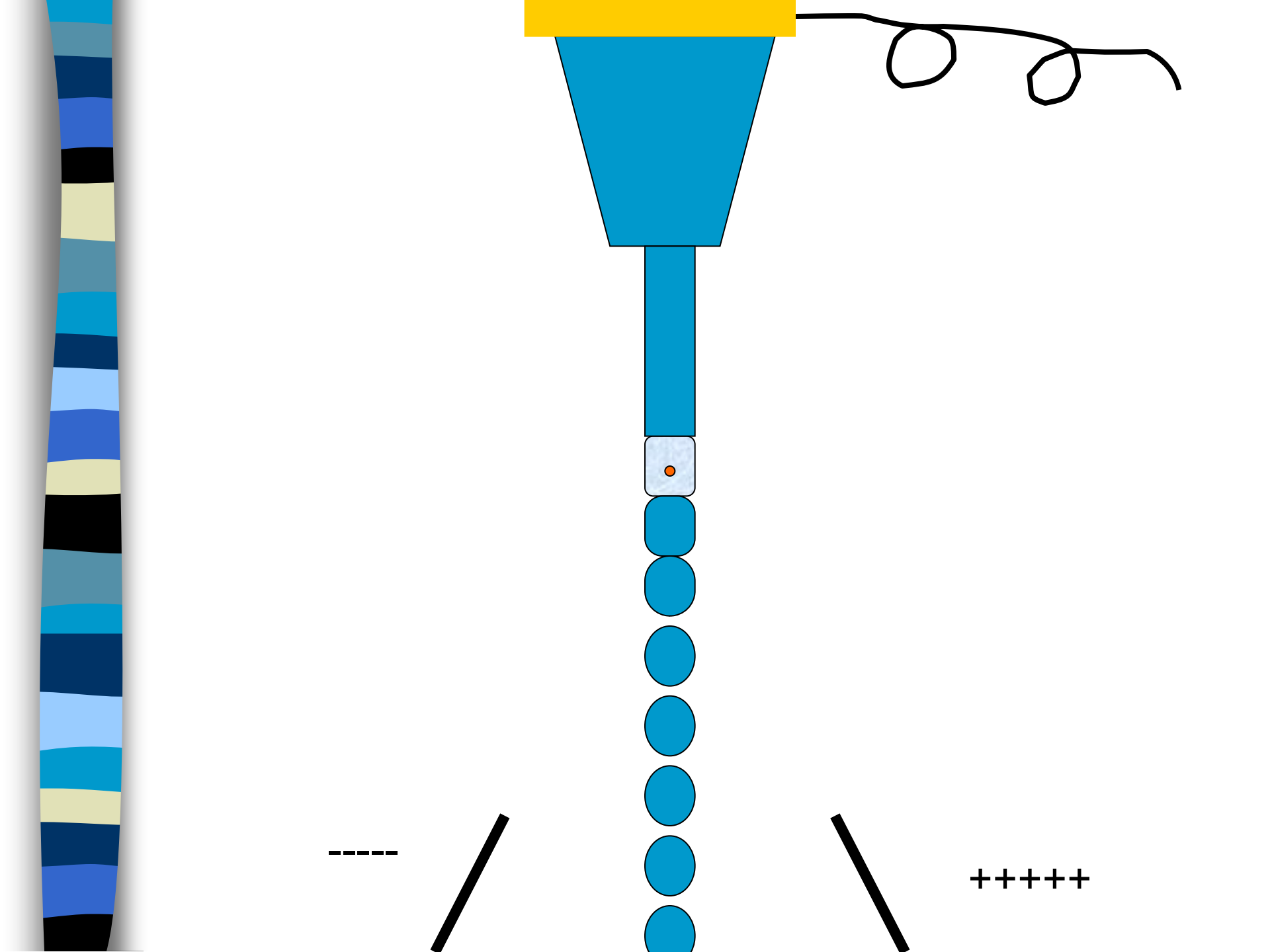

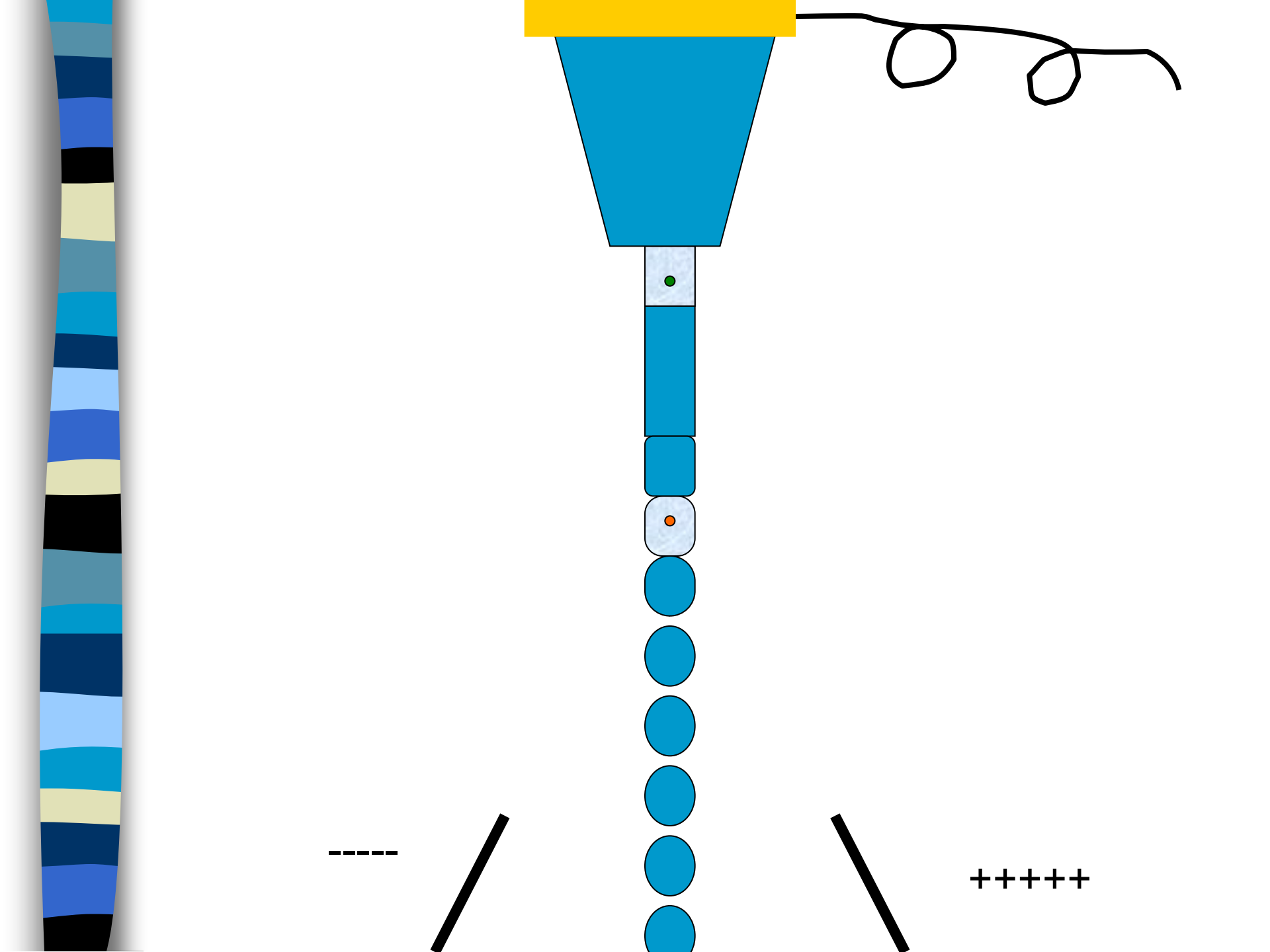

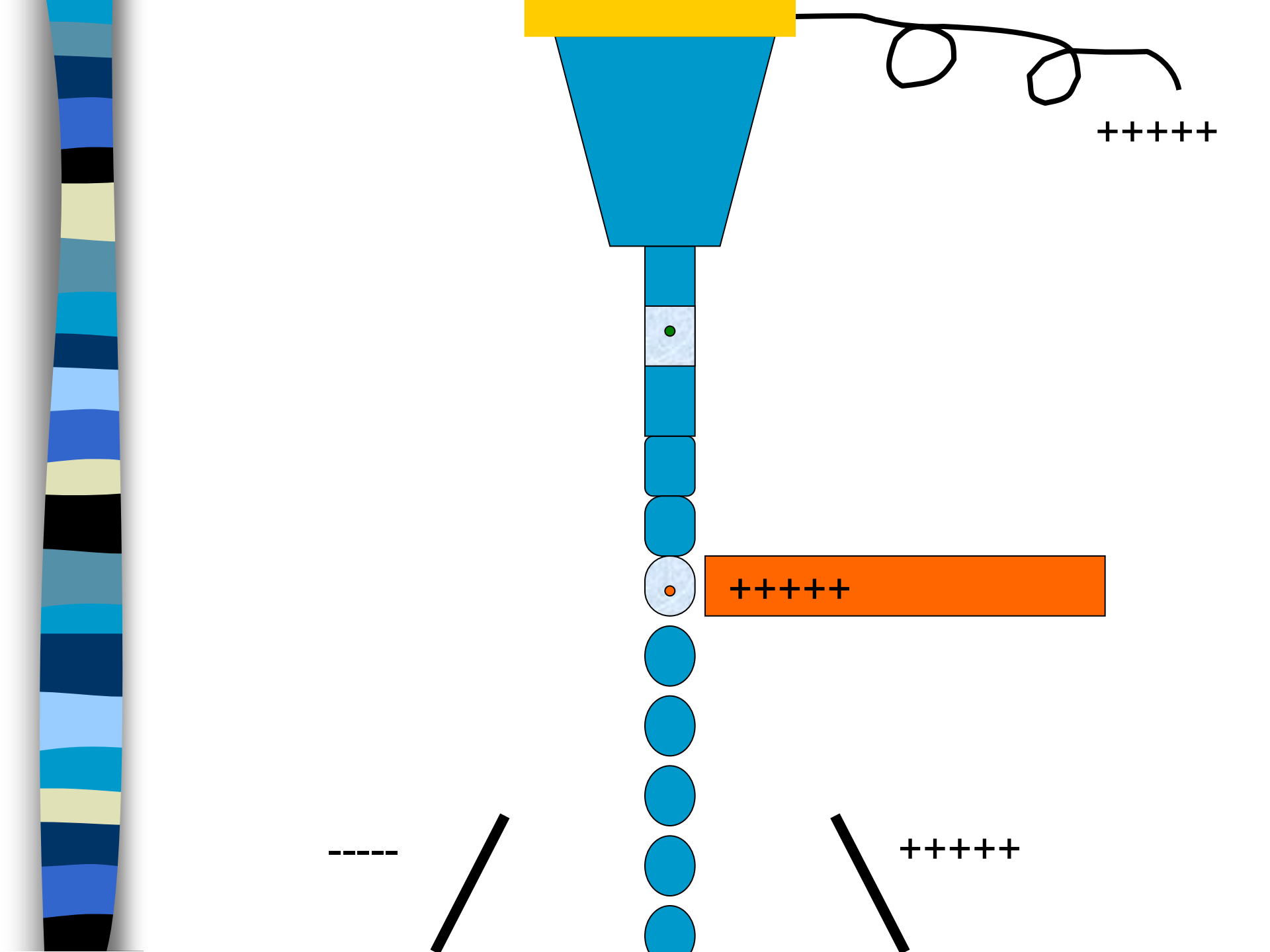

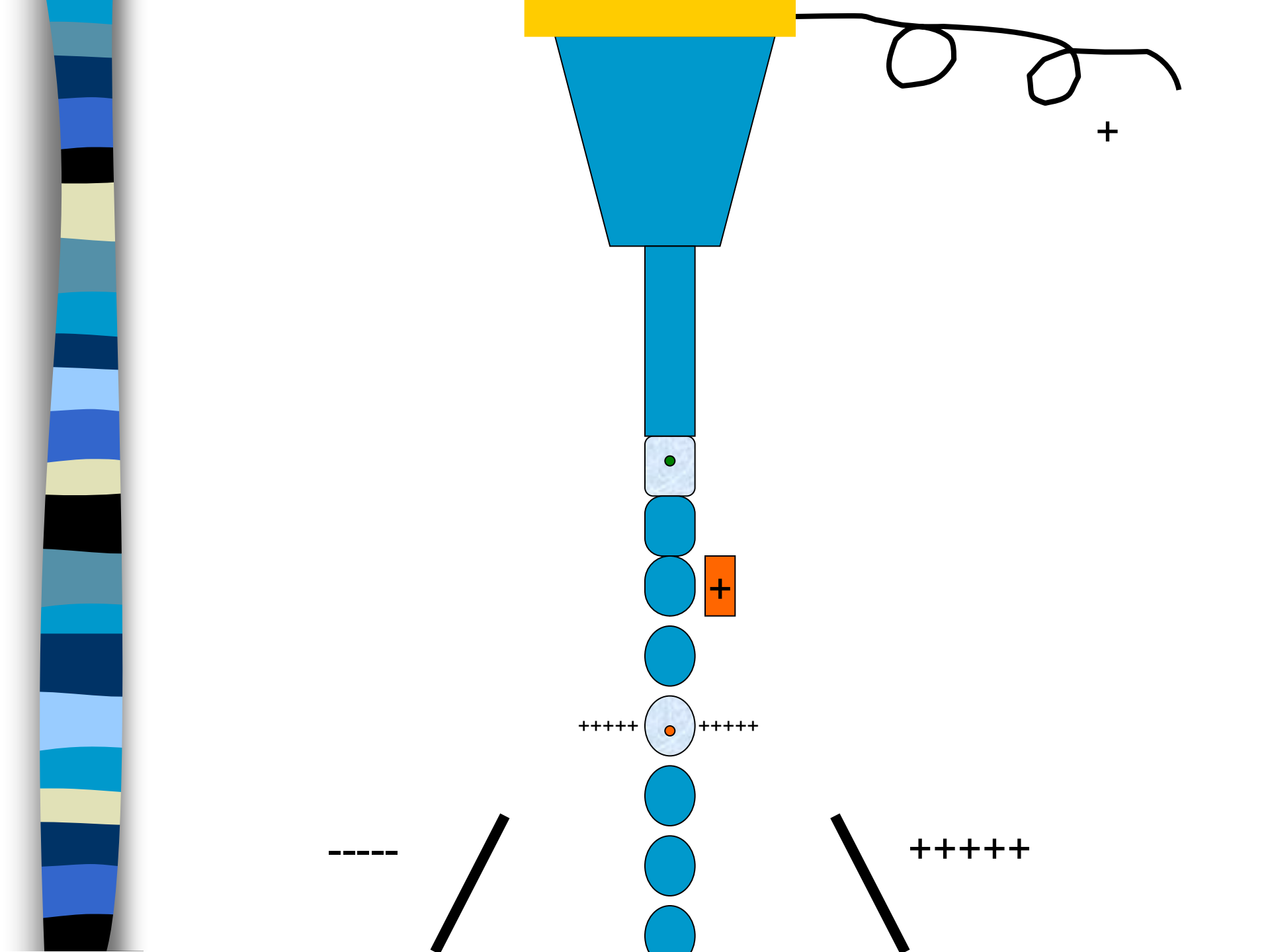

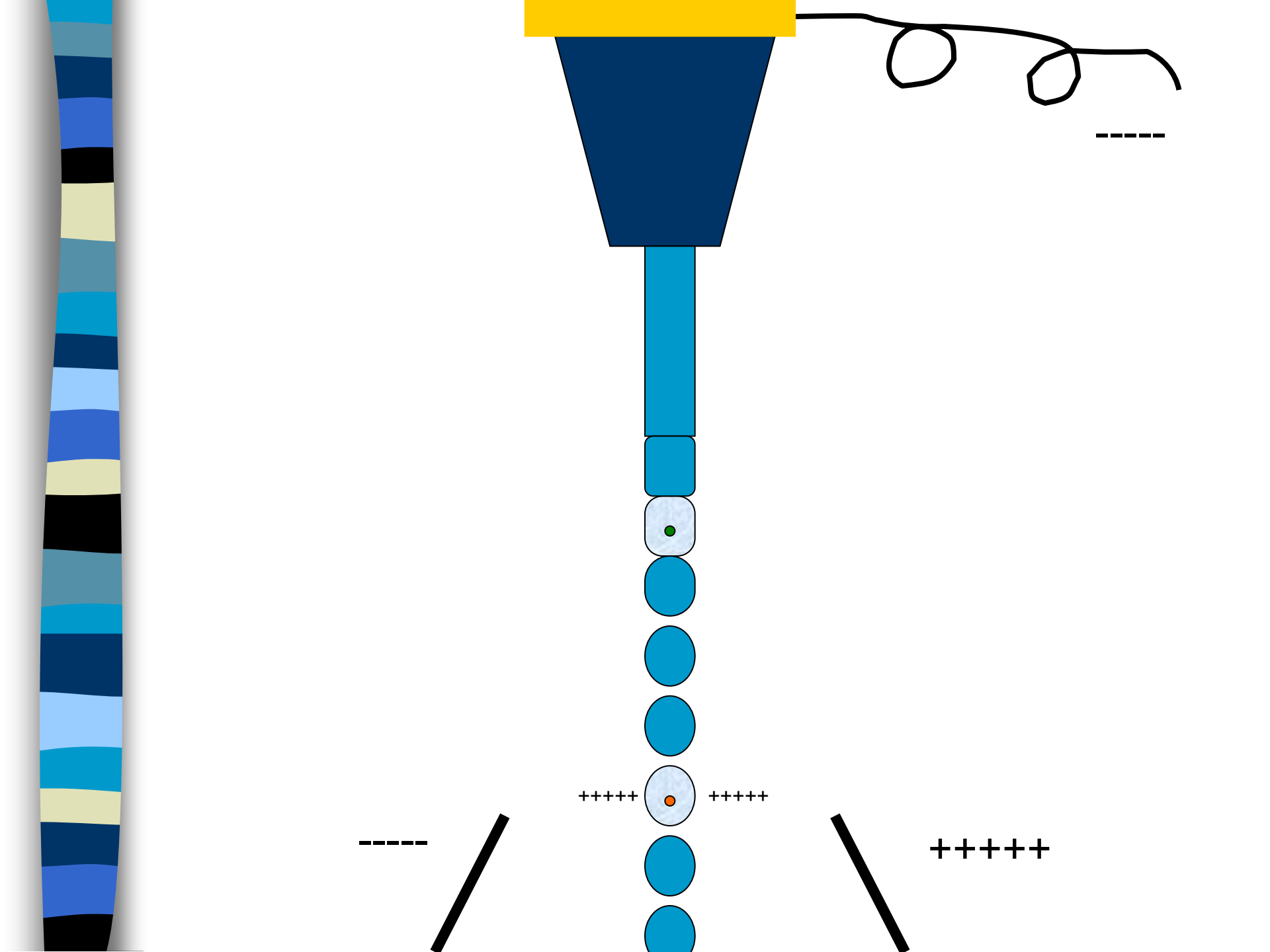

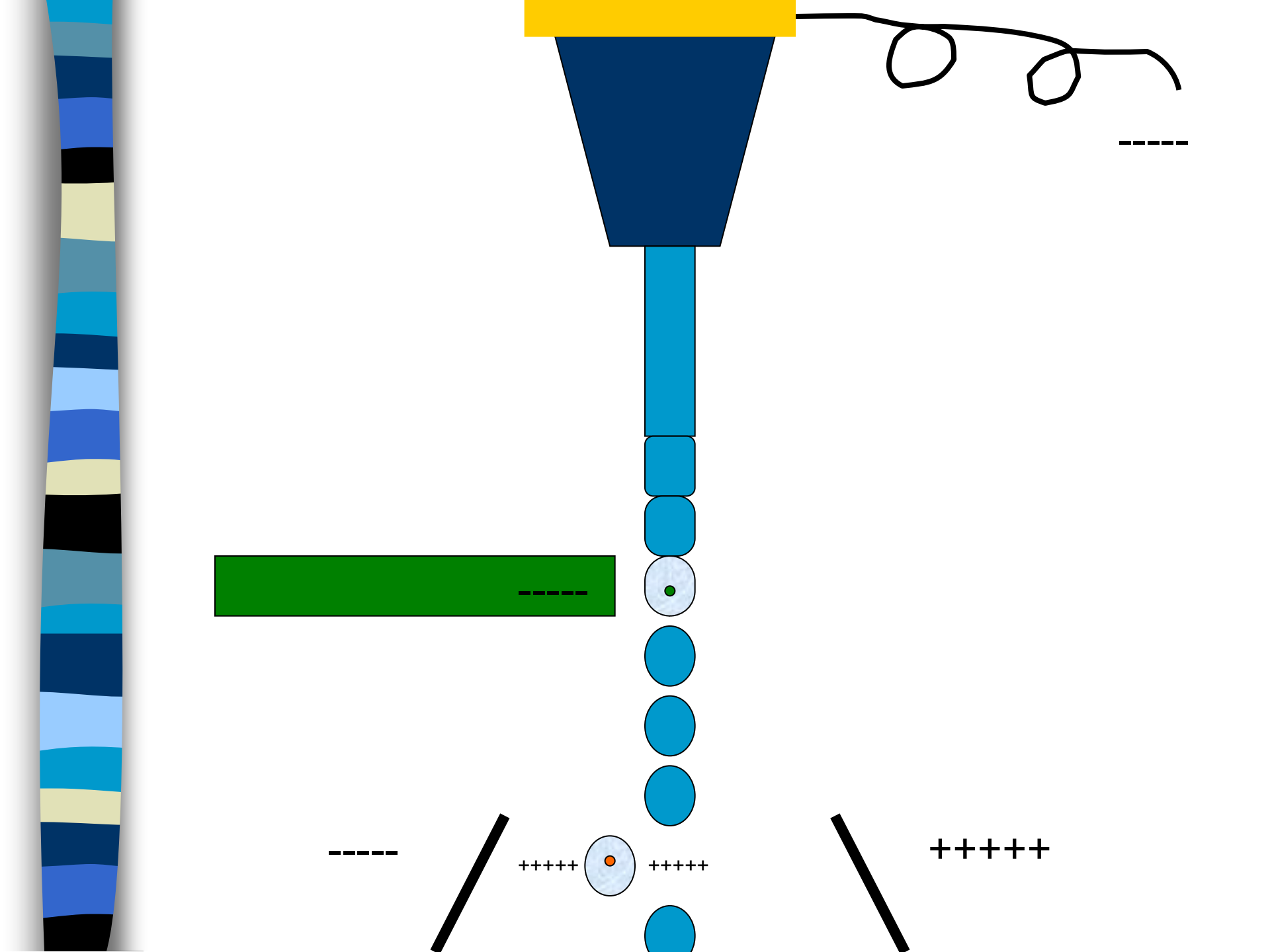

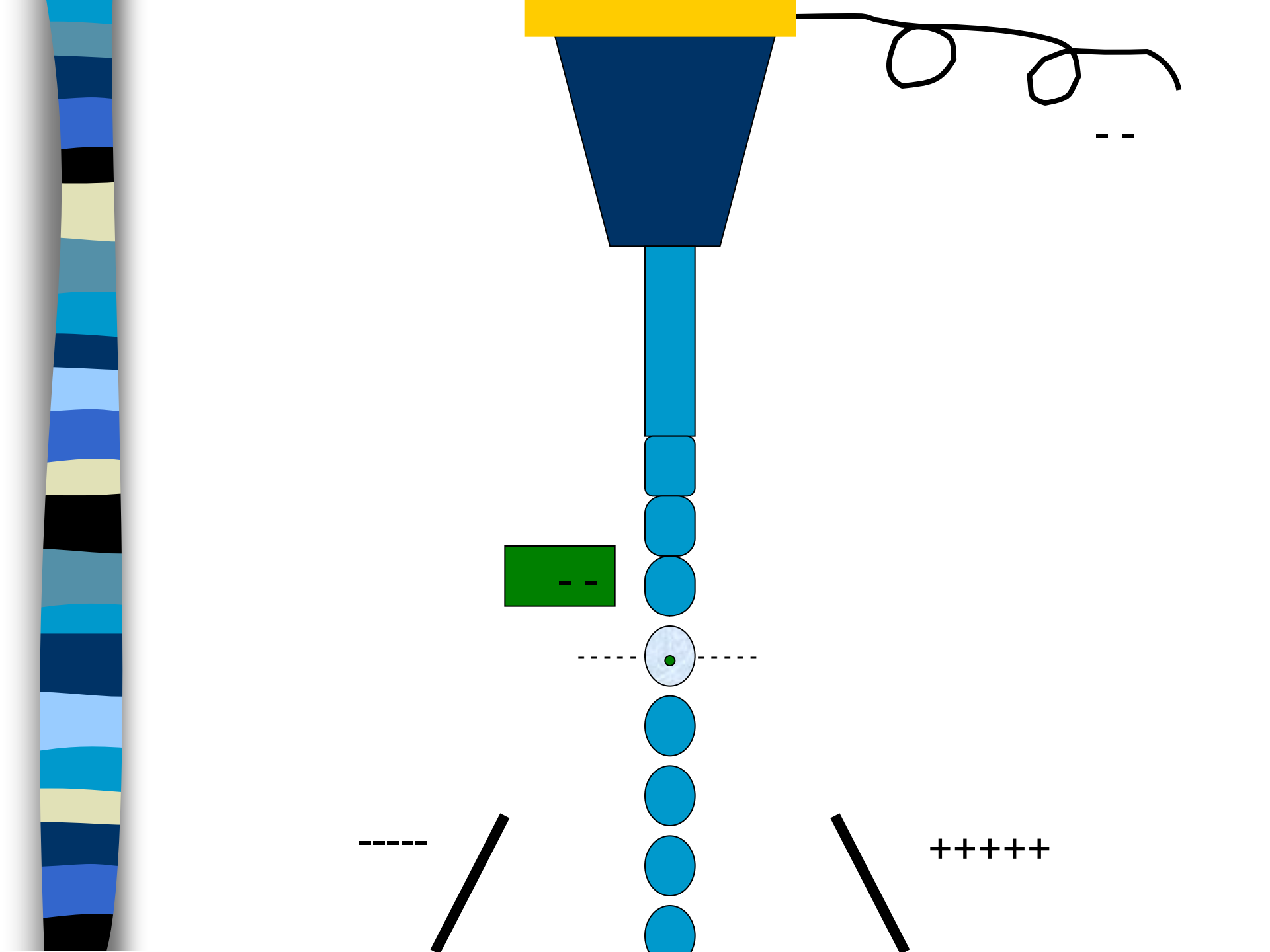

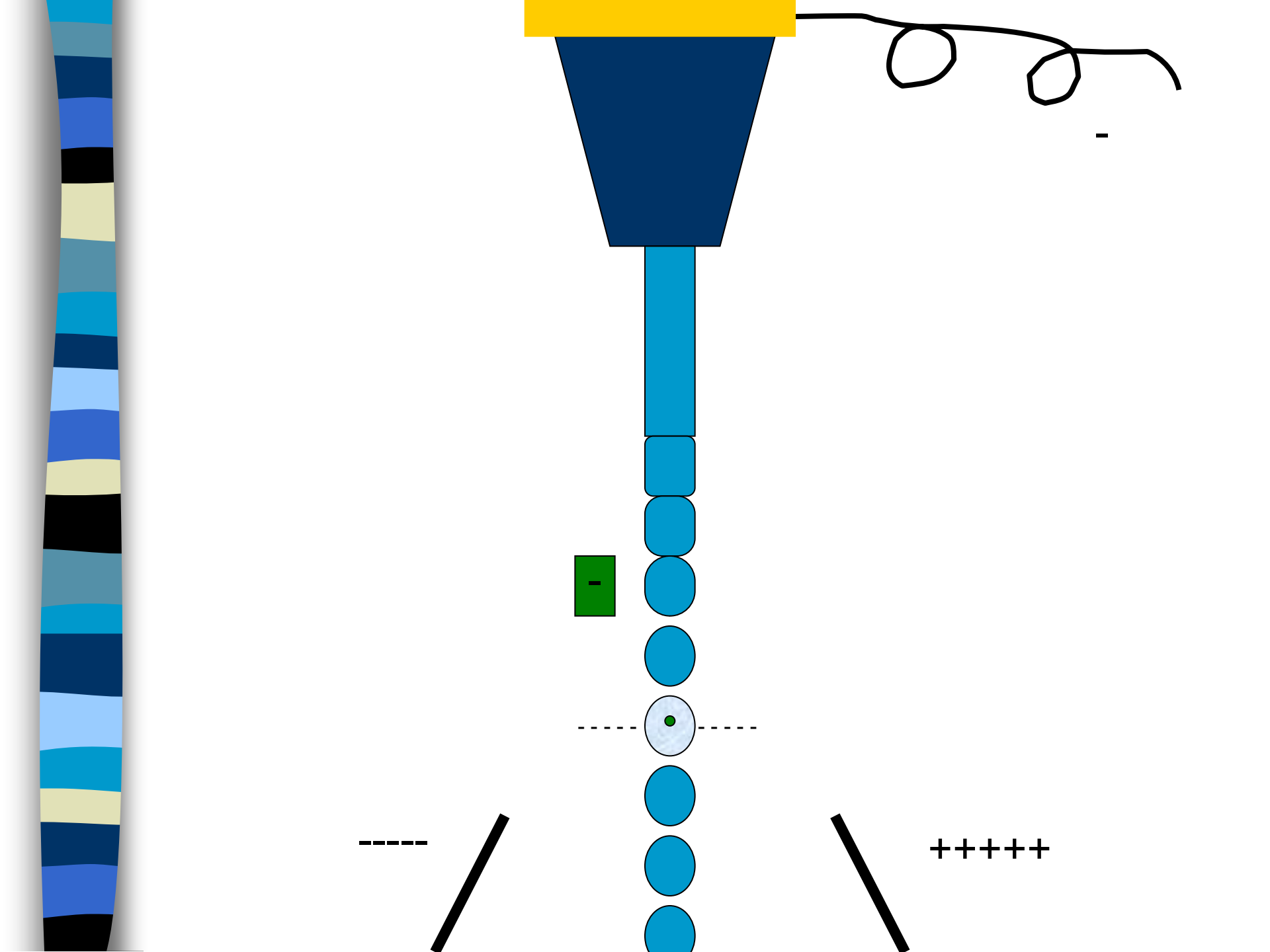

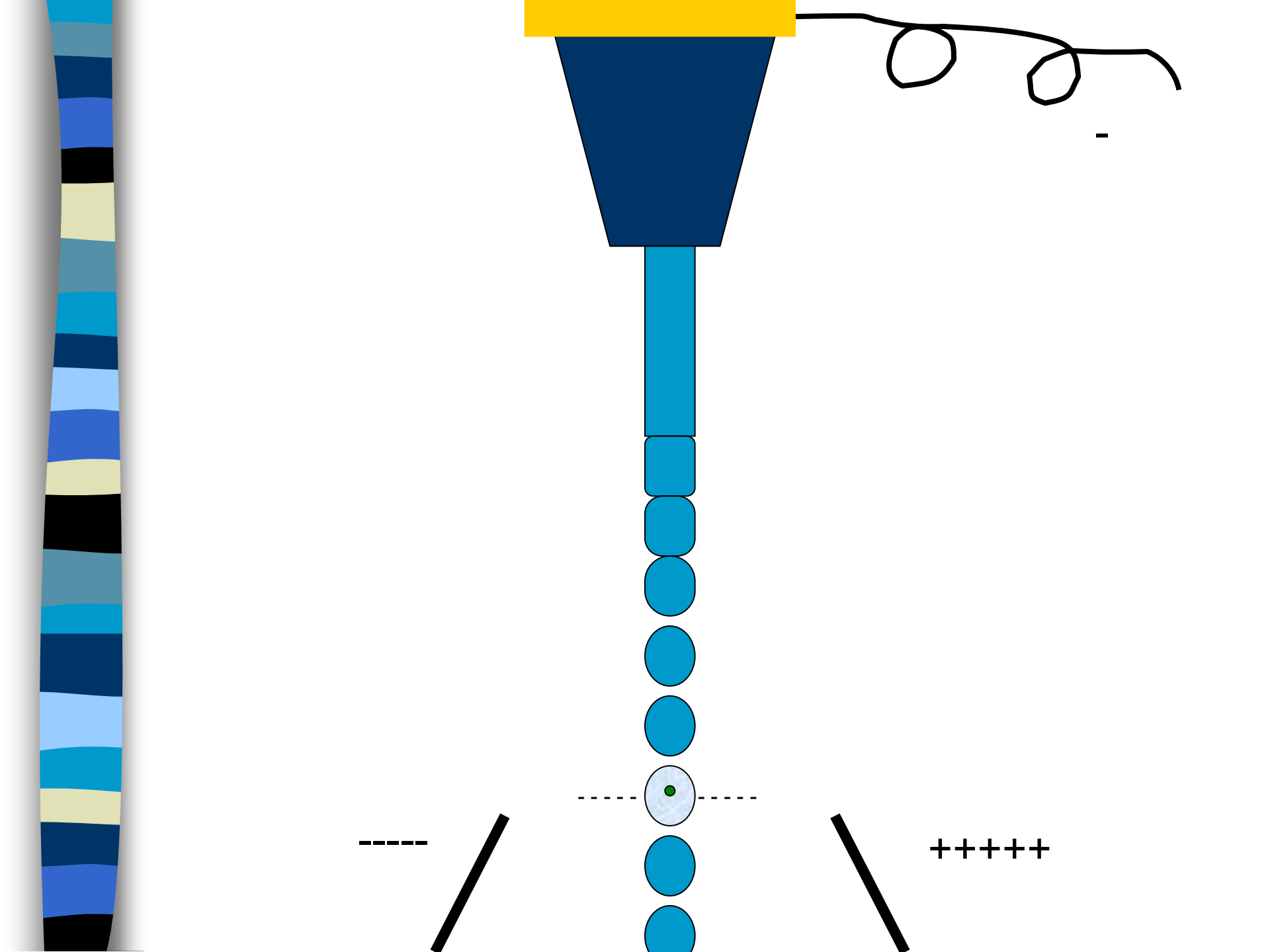

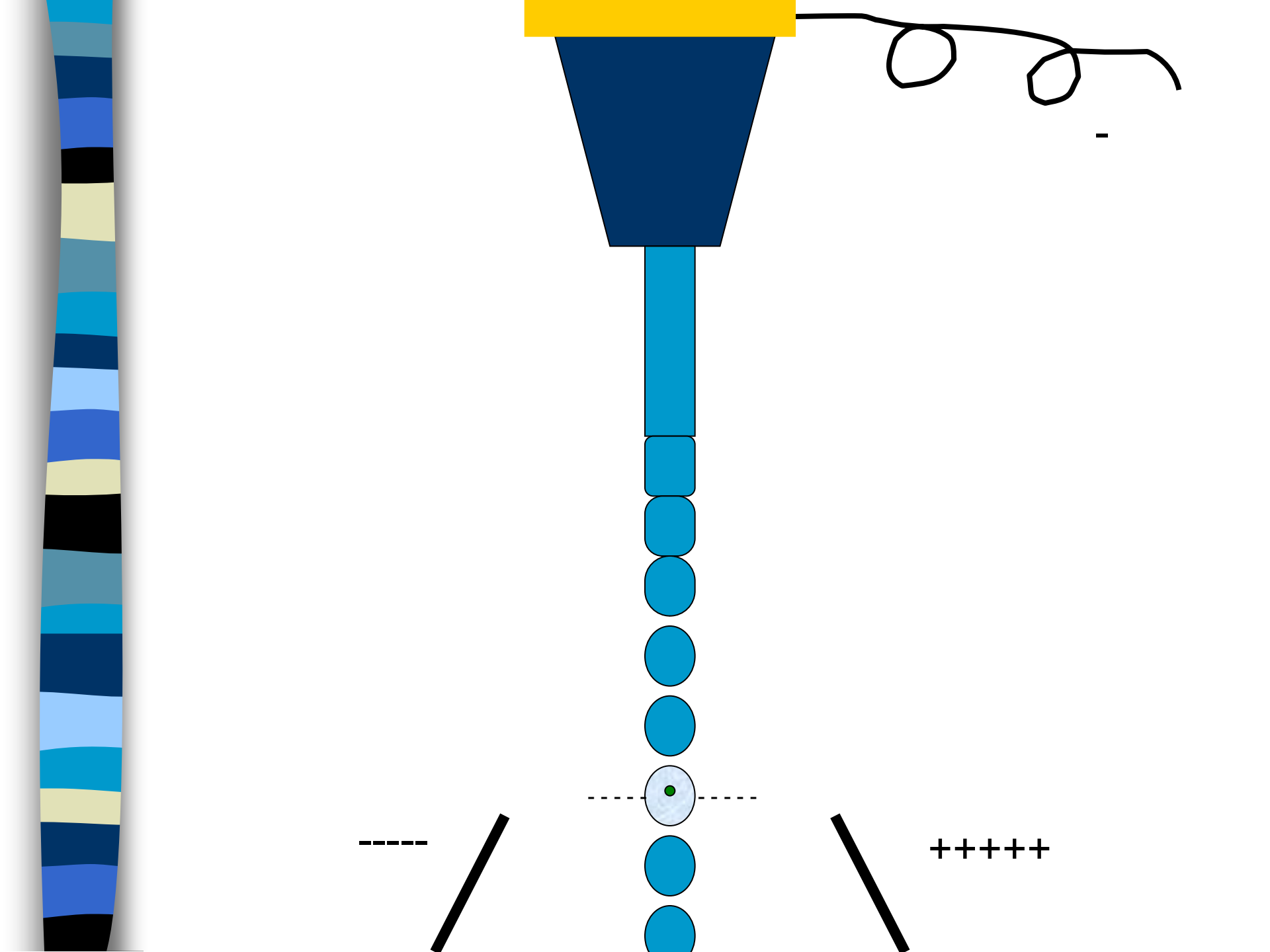

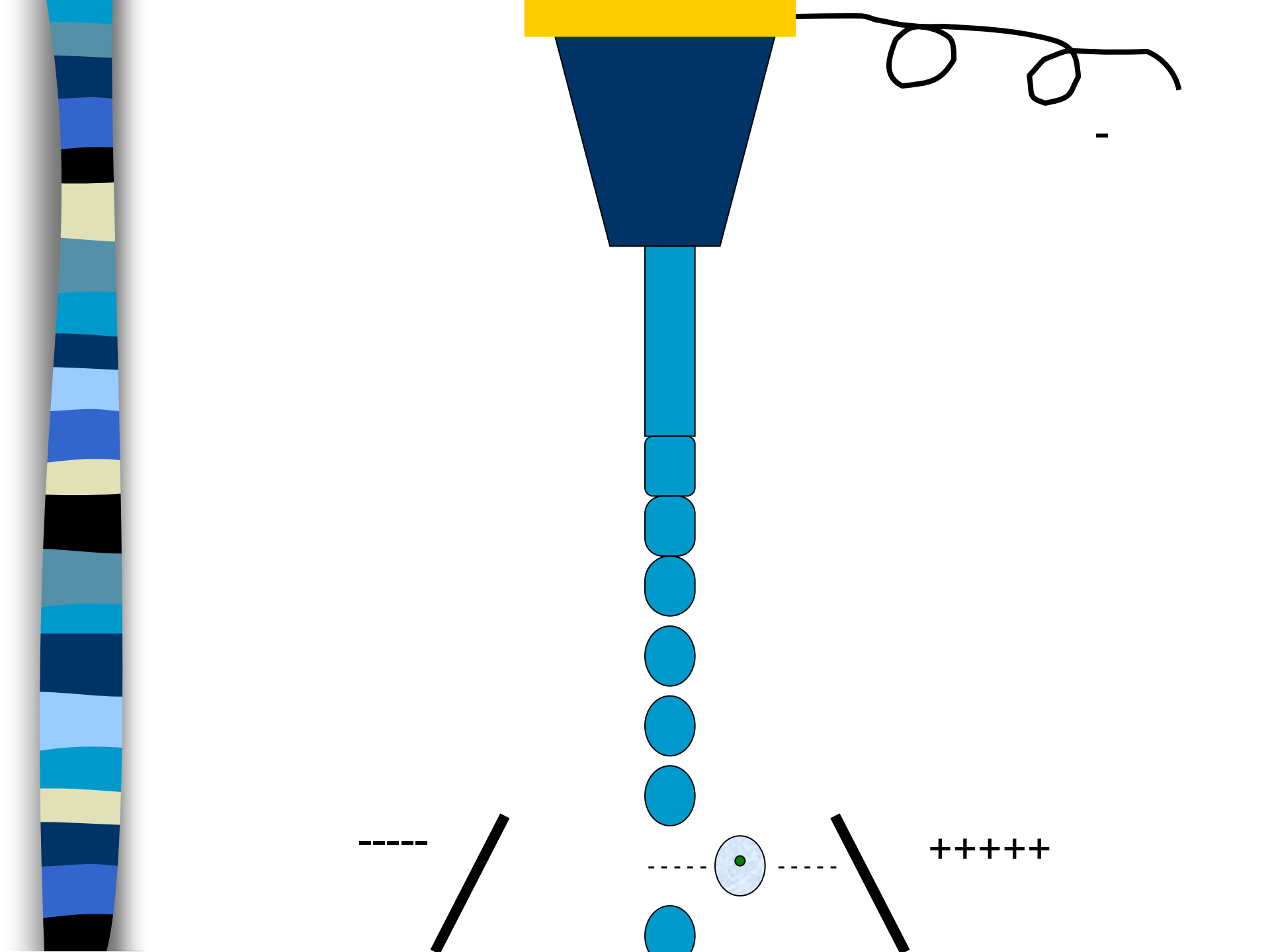

ISAC presents: Mack Fulwyler - Innovator, Inventor & Pioneer

<http://www.cyto.purdue.edu/cdroms/cyto10a/seminalcontributions/fulwyler.html>



Sorting - Sort Masks

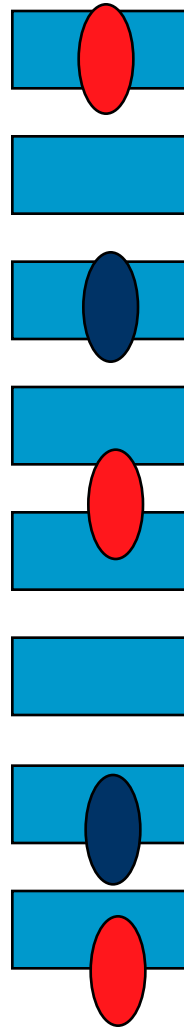

Cells are randomized
distributed over the stream

Sorting - Sort Masks

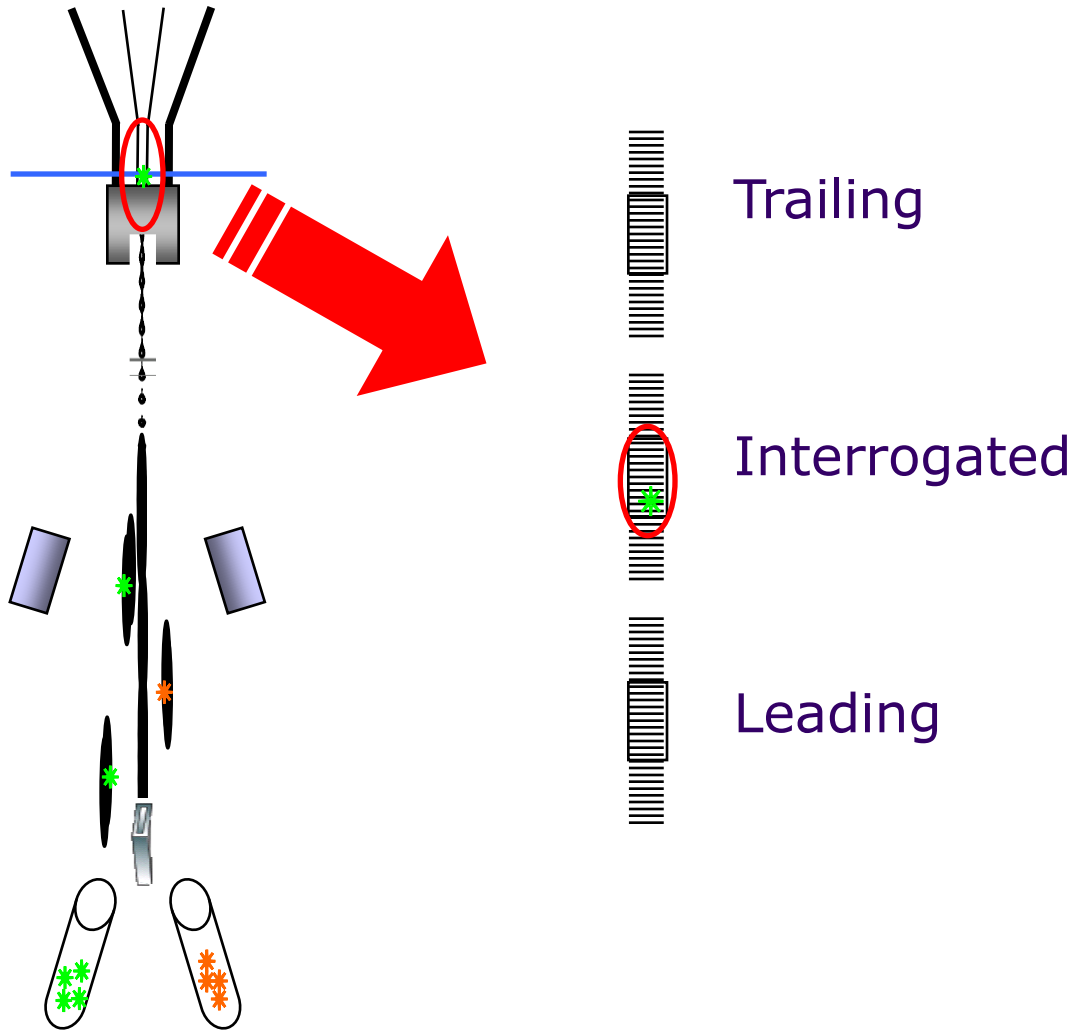

Mask

- A region of the stream monitored for the presence of cells
- Determines how drops will be deflected if a sorting conflict occurs
- Measured in 1/32 drop increments

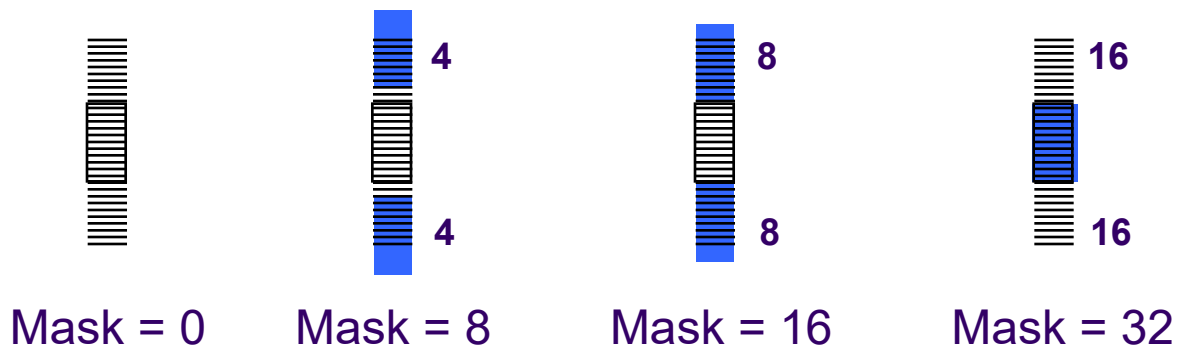

Conflict Resolution

- Precision modes include three types of masks

- Yield
- Purity
- Phase

	Precision Mode				
	Purity	Yield	Single Cell	Initial	Fine Tune
Yield Mask:	32	32	0	32	0
Purity Mask:	32	0	32	0	0
Phase Mask:	0	0	16	0	0
Single Cell:	<input type="checkbox"/>	<input type="checkbox"/>	<input checked="" type="checkbox"/>	<input type="checkbox"/>	<input type="checkbox"/>

Sorting - Sort Masks

Sort decisions are determined by sort masks

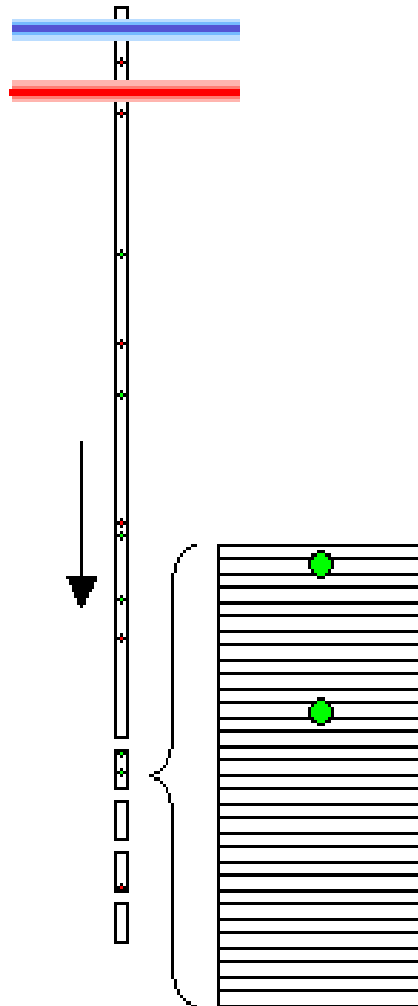

Target particles in a drop with
1/32-drop resolution

Sorting - Yield Mask

The yield mask defines how many drops will be sorted. Yield mask of 8/32 indicated in blue; target particle shown in green

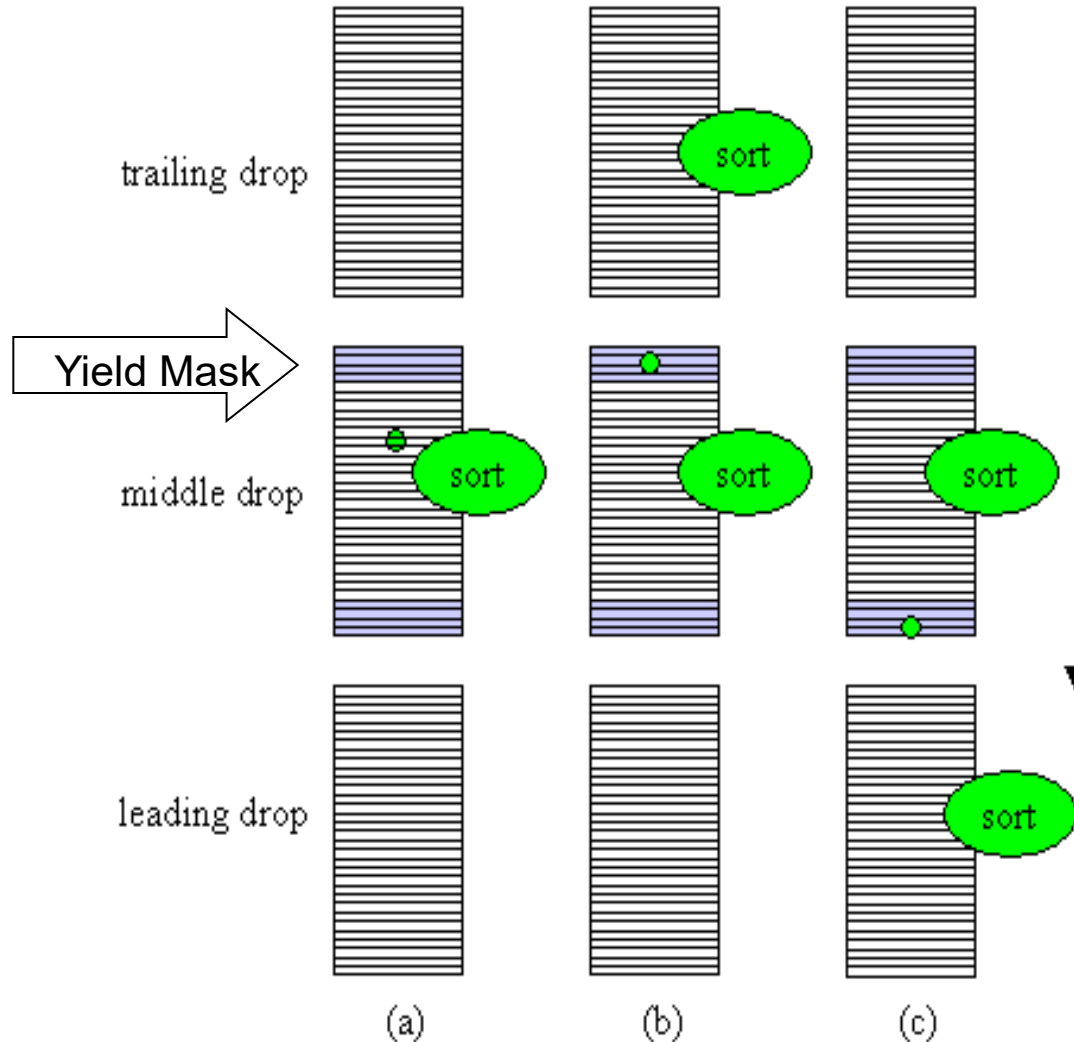

Sorting - Purity Mask

Purity mask of 8/32 in blue, 4/32 in each adjacent drop;
target particles in green, non-target particles in red

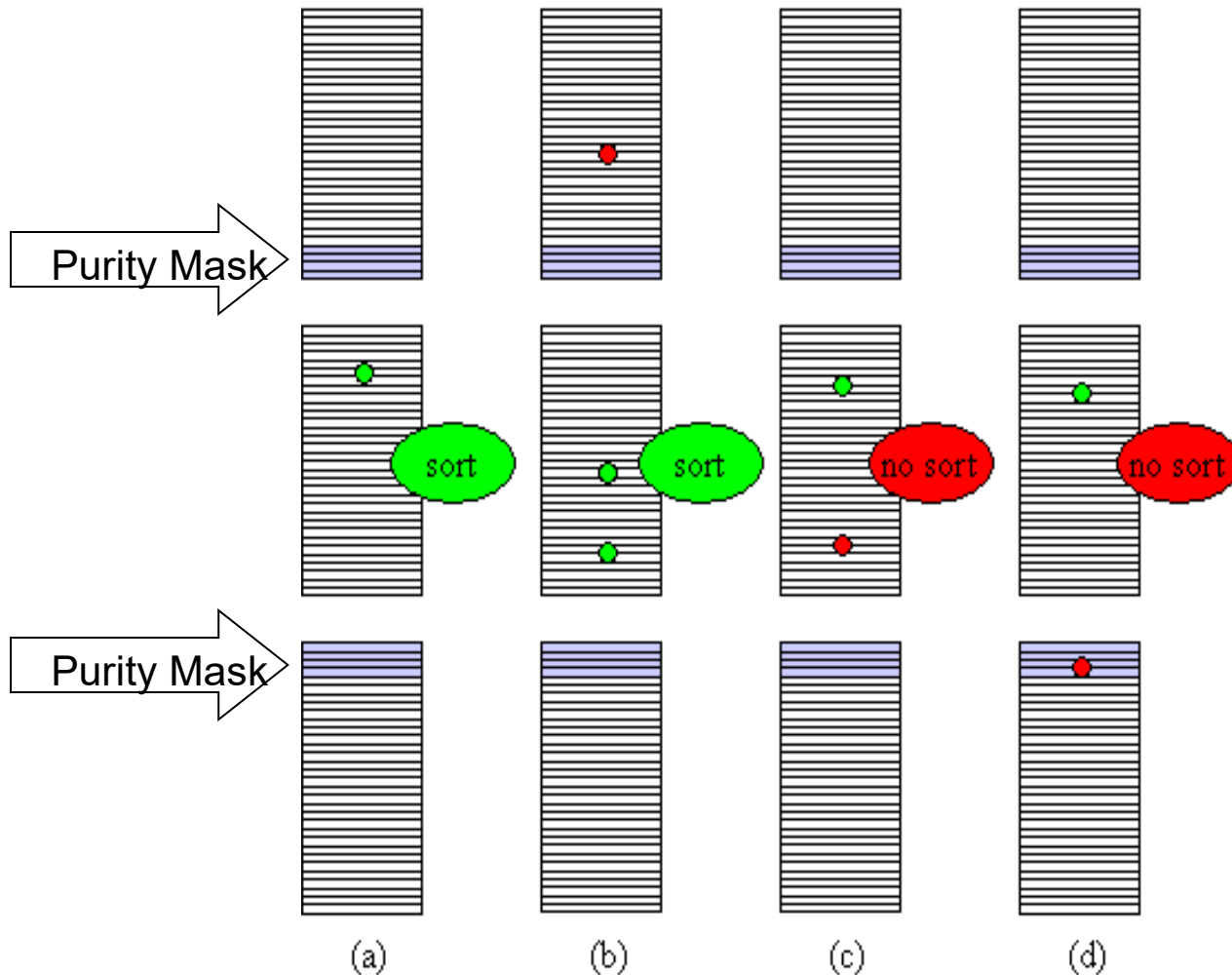

FLUIDIC SWITCH SORTER

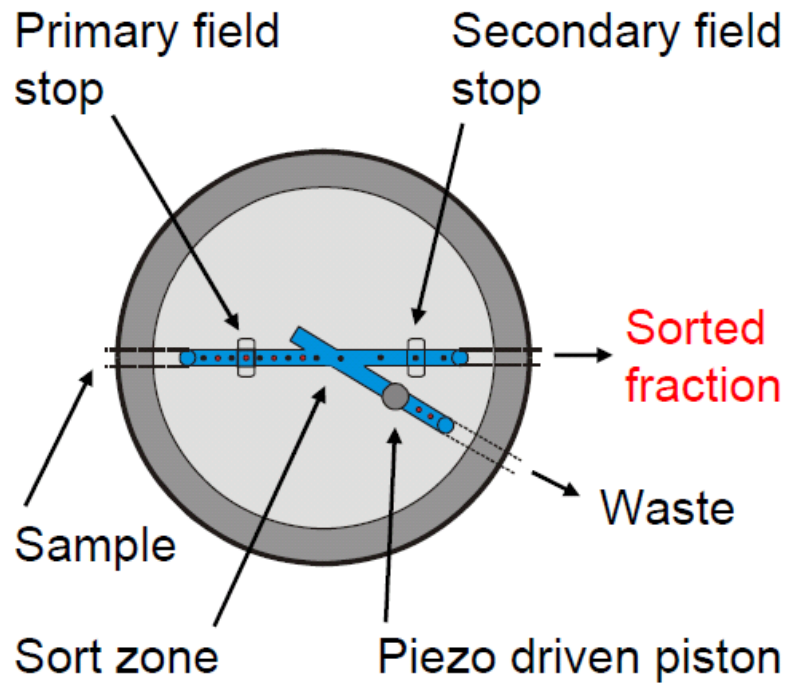

- Safety (enclosed stream)
- Gentle to cells
- Sorting of large particles ($>100 \mu\text{m}$)

Low speed ($\sim 100/\text{sec}$)

- Dilute sorted fraction
- Noisy

Used by: Partec

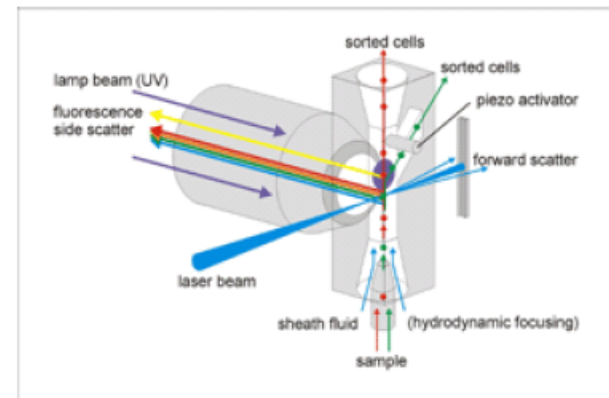
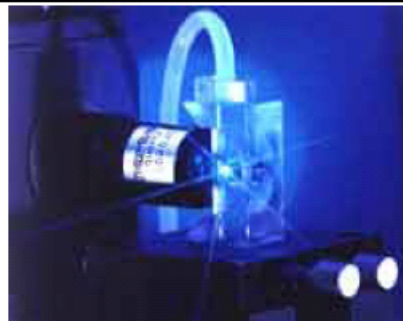

FLUIDIC SWITCH SORTER

- Safety (enclosed stream)
- Gentle to cells
- Low speed (~ 100 / sec)
- Dilute sorted fraction
- Noisy

Used by: Becton Dickinson

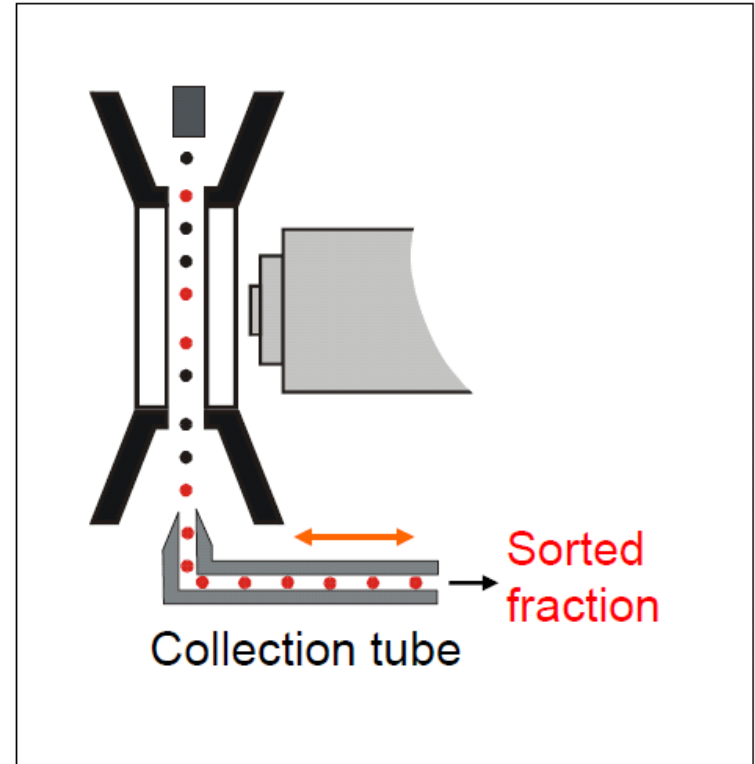

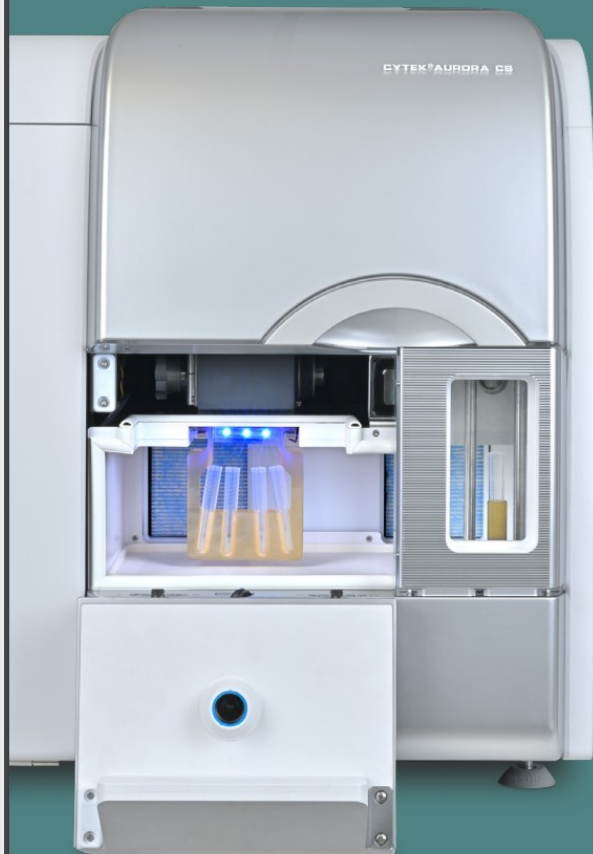

Why Choose the Cytek® Aurora CS?

- So Many Colors
40 colors demonstrated including fluorochromes with emission spectra in close proximity to each other.
- Exceptional Sensitivity and Resolution
Sensitivity redefined using state-of-the-art optics and low-noise electronics.
Extract autofluorescence and improve resolution of highly autofluorescent samples.
- New Levels of Flexibility
No need to reconfigure optical filters for different fluorochromes.
Use any commercially available fluorochrome excited by the onboard lasers.
Choose from a variety of sample input and collection devices including 5 and 15 mL tubes for input and 96-well plates, 1.5 and 5 mL tubes for collection.
- Seamless Sorting Experience
Automated drop delay, sort monitoring, and clog detection for a reliable sorting experience.
Comprehensive sort reports automatically record settings used from every sort.
Assay transferability from the Cytek Aurora system or conventional flow cytometers.

Predefined and Custom Sort Modes

Select one of Cytek's predefined sort modes or create a custom defined sort mode to meet the needs of each user's sorting application.

➤ Purity

Isolate the population of interest with little to no contaminants from other populations

➤ Enrich

Prioritize retrieving a high number of the target population with reduced sort purity

➤ Multiway

Intended for 4- or 6-way sorting for efficient drop deflection

➤ Single Cell

Isolate single cells into 96-well plates

➤ Mixed

A combination of Purity and Enrich modes

➤ Custom

Adjust the sort decision settings to meet your application needs

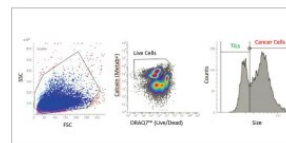

Label-free identification of TILs and cancer cells based on size

Fluorescent localization

Reveal the spatial context of fluorescent signals hidden in flow cytometry. Track the subcellular movement of a protein across organelle boundaries within the cell, such as the NFκB translocation from the cytoplasm to the nucleus.

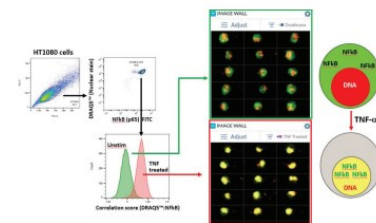

Configurations				
Number of spectral lasers	3	4	4	5
Number of fluorescent detectors	44	56	66	78
Total detectors	52	64	74	86
Lasers				
Ultraviolet laser (349 nm)			●	●
Violet laser (405 nm)	●	●	●	●
Blue laser (488 nm)	●	●	●	●
Yellow-green laser (561 nm)		●		●
Red laser (638 nm)	●	●	●	●

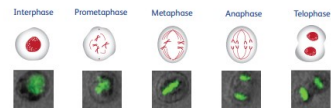

Cell cycle analysis

Flow cytometry methods only rely on a single indicator of DNA content for cell cycle classification, which is incomplete. Image feature analysis can provide insight into DNA distribution information to differentiate the phases of the cell cycle.

Cell-cell interaction

Reveal the spatial context of cells using image feature analysis to identify combinations of engaged cells. Distinguish between two cells that are coincident (passed through the interrogation point in close proximity) and true doublets (cells that are actually touching each other). Further image analysis can reveal receptor accumulation at the site of the cell-cell synapse (active synapse).

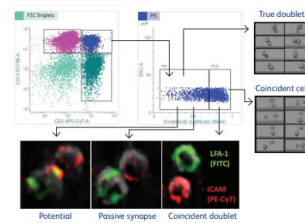



Cell sorting - trends

- Easy operation
- Careful handling
 - On-chip technology
- Size ↓ and security ↑
- Microfluidic-based cell sorting
- Spectral cell sorting
- Image-based sorting

- Buoyancy Activated Cell Sorting (BACS™)
 - a method that uses low-density particles (microbubbles) for flotation separation.

Electronics and data

File size considerations

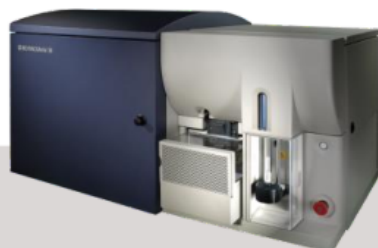

FCS data

- Saved for selected channels only
- H/W optional
- 10,000 events → ~2 MB for an 8-color experiment

Data management is vitally important for spectral and imaging cytometers



FCS data

- Saved for all channels
- A/H/W/TTP always saved
- 10,000 events → ~17 MB for any experiment

Image files

- All imaging features saved for selected imaging channels
- Larger cells will generate larger image files
- 10,000 events → ~1.5 GB for a PBMC experiment

Date: 17-JUL-2015
 System: Windows XP 5.1
 Cytometer: FACSAriaII SORP (FACSAriaII)
 File: 150717_DU145 Ctrl.fcs
 File URI: file://C:/Users/user/Desktop/install/Infinicyt/150717_DU145%20Ctrl.fcs

 \$BEGINANALYSIS: 0
 \$BEGINDATA: 4148
 \$BEGINTEXT: 0
 \$BTIM: 13:25:01
 \$BYTEORD: 4,3,2,1
 \$CYT: FACSAriaII SORP (FACSAriaII)
 \$DATATYPE: F
 \$DATE: 17-JUL-2015
 \$ENDANALYSIS: 0
 \$ENDDATA: 6055267
 \$ENDTEXT: 0
 \$ETIM: 13:28:55
 \$FIL: 150717_DU145 Ctrl.fcs
 \$INST: IBP
 \$MODE: L
 \$NEXTDATA: 0
 \$OP: fedr
 \$PAR: 19
 \$SRC: 150717
 \$SYS: Windows XP 5.1
 \$TIMESTEP: 0.01
 \$TOT: 79620
 APPLY COMPENSATION: TRUE
 AUTOBS: TRUE
 CREATOR: BD FACSDiva Software Version 6.1.3
 CST BASELINE DATE: 03_24_2015 12:52:48 PM
 CST BEADS LOT ID: 91725
 CST SETUP DATE: 03_25_2015 03:01:55 PM
 CST SETUP STATUS: SUCCESS WITH WARNING
 CYTNUM: P5Y500001
 CYTOMETER CONFIG CREATE DATE: 05_13_2013 01:32:45 PM
 CYTOMETER CONFIG NAME: RF_85u 45 psi_SORP Aria_5-laser (Zuv-6v-3b-5yg-3r)
 EXPERIMENT NAME: DU145_POPRO1_LDYellow_AF488_AF594_PE_APCcy7
 EXPORT TIME: 17-JUL-2015-14:30:11
 EXPORT USER NAME: fedr
 FJ_FCS_VERSION: 3
 FSC ASF: 0.57
 GUID: dc7612a3-65af-4520-bc0f-51d53273ebea
 LASER1ASF: 0.86
 LASER1DELAY: 0.00
 LASER1NAME: Blue
 LASER2ASF: 0.86
 LASER2DELAY: -38.47
 LASER2NAME: Red
 LASER3ASF: 1.02
 LASER3DELAY: 77.49
 LASER3NAME: UV
 LASER4ASF: 0.63
 LASER4DELAY: 45.00
 LASER4NAME: Violet
 LASER5ASF: 0.83
 LASER5DELAY: -76.49
 LASER5NAME: YG
 P10BS: 602
 P10DISPLAY: LOG
 P10MS: 0
 P11BS: 38
 P11DISPLAY: LOG
 P11MS: 0
 P12BS: 5
 P12DISPLAY: LOG
 P12MS: 0
 P13BS: 1118
 P13DISPLAY: LOG
 P13MS: 0

Compensation Matrix

	Alexa Fluor 594-A	DAPI (405nm)-A	Alexa Fluor 647-A	PE-A	Alexa Fluor 488-A	APC-Cy7-A	Qdot 605-A
Alexa Fluor 594-A	100	0.42	1.53	1.94	0.02	0.32	9.95
DAPI (405nm)-A	1.1	100	0.27	0.05	0.01	0.08	0.98
Alexa Fluor 647-A	2.45	22.87	100	0.1	0.08	15.14	0.85
PE-A	440.67	0	0.14	100	8.03	0.03	32.23
Alexa Fluor 488-A	-0.01	0.09	0.01	0	100	0	0.05
APC-Cy7-A	0.01	0.04	2.67	0	0.05	100	0.01
Qdot 605-A	0	41.05	0	0	2.34	0	100

Parameters and Stains

Parameter (\$PnI)	Stain (\$PnS)	Range (\$PnR)	Bits (\$PnB)	Decades (\$PnE)	Gain (\$PnG)	Voltage (\$PnV)	Derived From
FSC-A		262144	32	0.0	1.0	280	
FSC-H		262144	32	0.0	1.0	280	
SSC-A		262144	32	0.0	1.0	210	
Alexa Fluor 594-A		262144	32	0.0	1.0	460	
Alexa Fluor 594-H		262144	32	0.0	1.0	460	
DAPI (405nm)-A		262144	32	0.0	1.0	650	
DAPI (405nm)-H		262144	32	0.0	1.0	650	
DAPI (405nm)-W		262144	32	0.0	1.0	650	
Alexa Fluor 647-A		262144	32	0.0	1.0	538	
Alexa Fluor 647-H		262144	32	0.0	1.0	538	
PE-A		262144	32	0.0	1.0	330	
PE-H		262144	32	0.0	1.0	330	
Alexa Fluor 488-A		262144	32	0.0	1.0	366	
Alexa Fluor 488-H		262144	32	0.0	1.0	366	
APC-Cy7-A		262144	32	0.0	1.0	700	
APC-Cy7-H		262144	32	0.0	1.0	700	
Qdot 605-A		262144	32	0.0	1.0	410	
Qdot 605-H		262144	32	0.0	1.0	410	
Time		262144	32	0.0	0.01		
Comp-Alexa Fluor 594-A		262144					
Comp-DAPI (405nm)-A		262144					
Comp-Alexa Fluor 647-A		262144					
Comp-PE-A		262144					
Comp-Alexa Fluor 488-A		262144					
Comp-APC-Cy7-A		262144					
Comp-Qdot 605-A		262144					

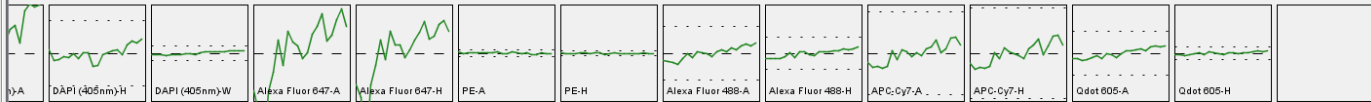

Data Acquisition - Listmode

<i>Event</i>	<i>Param1</i> <i>FS</i>	<i>Param2</i> <i>SS</i>	<i>Param3</i> <i>FITC</i>	<i>Param4</i> <i>PE</i>
1	50	100	80	90
2	55	110	150	95
3	110	60	80	30

Creation of a Voltage Pulse

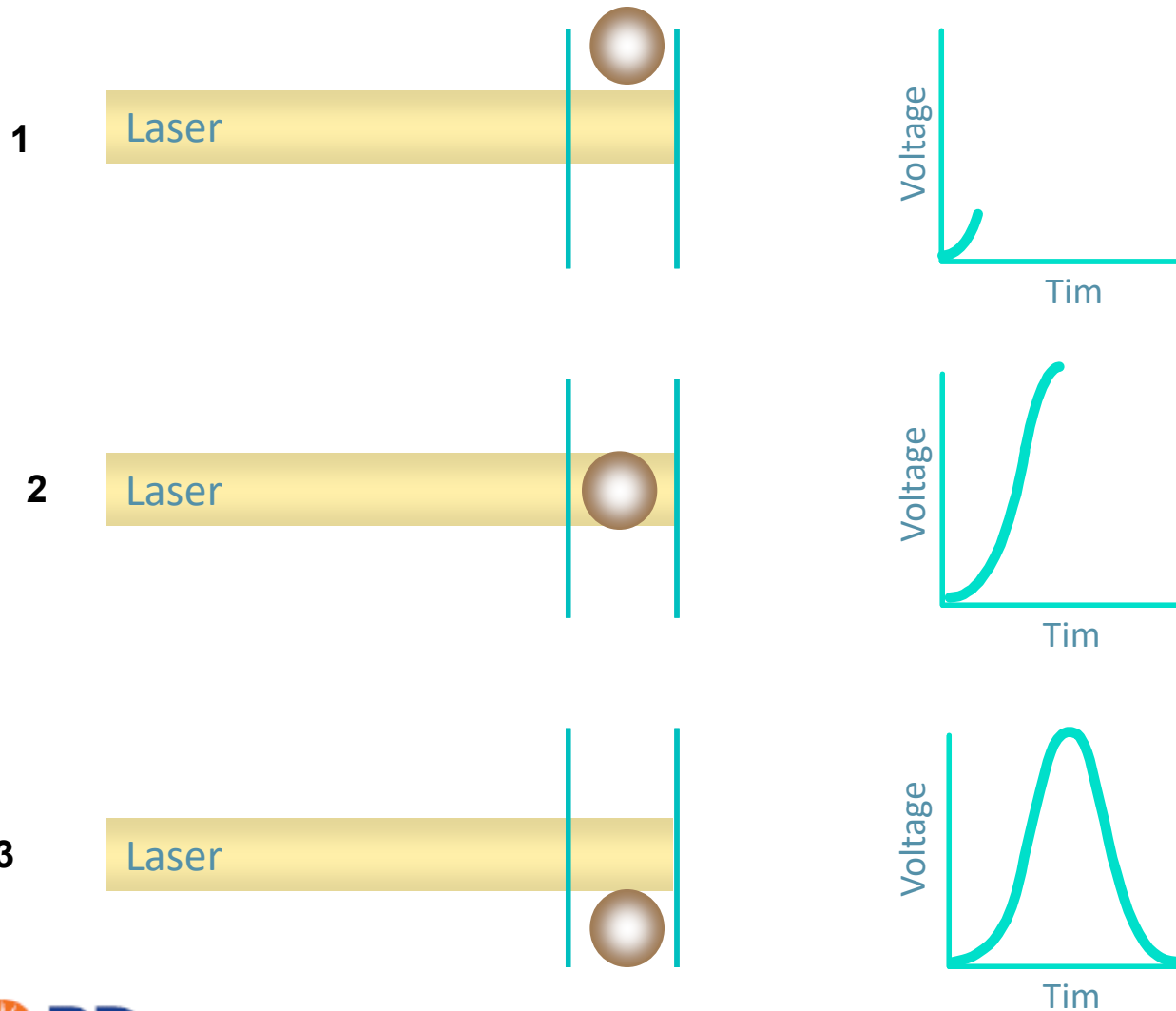

Height, Area, and Width

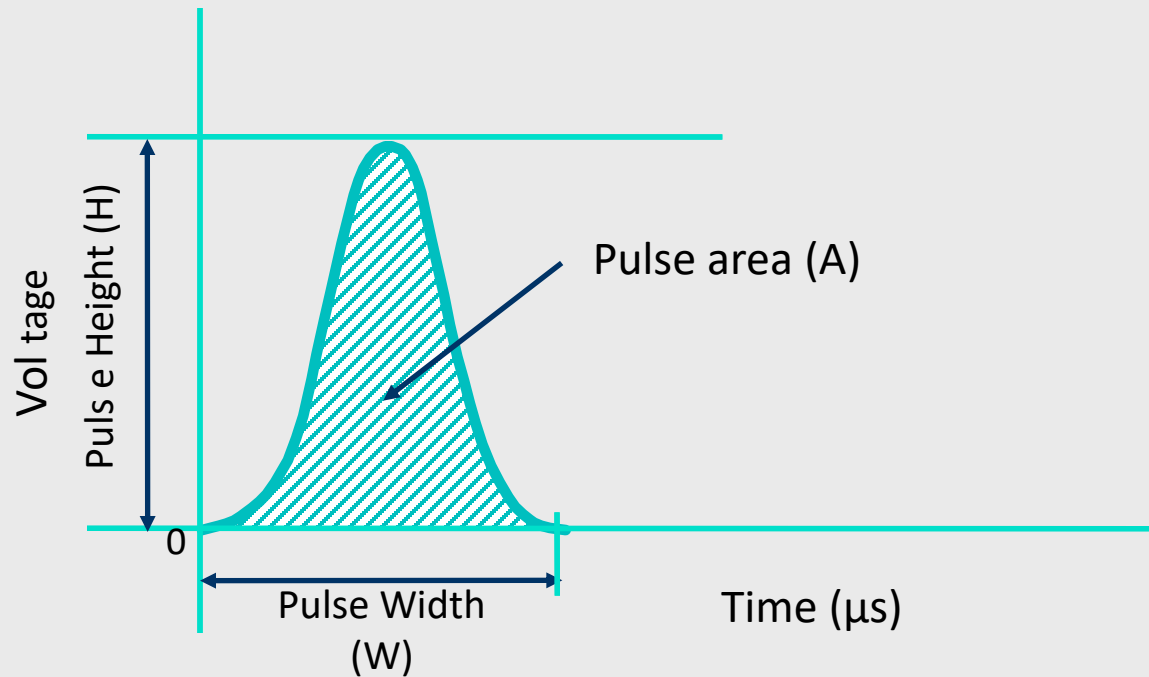

Signal processing

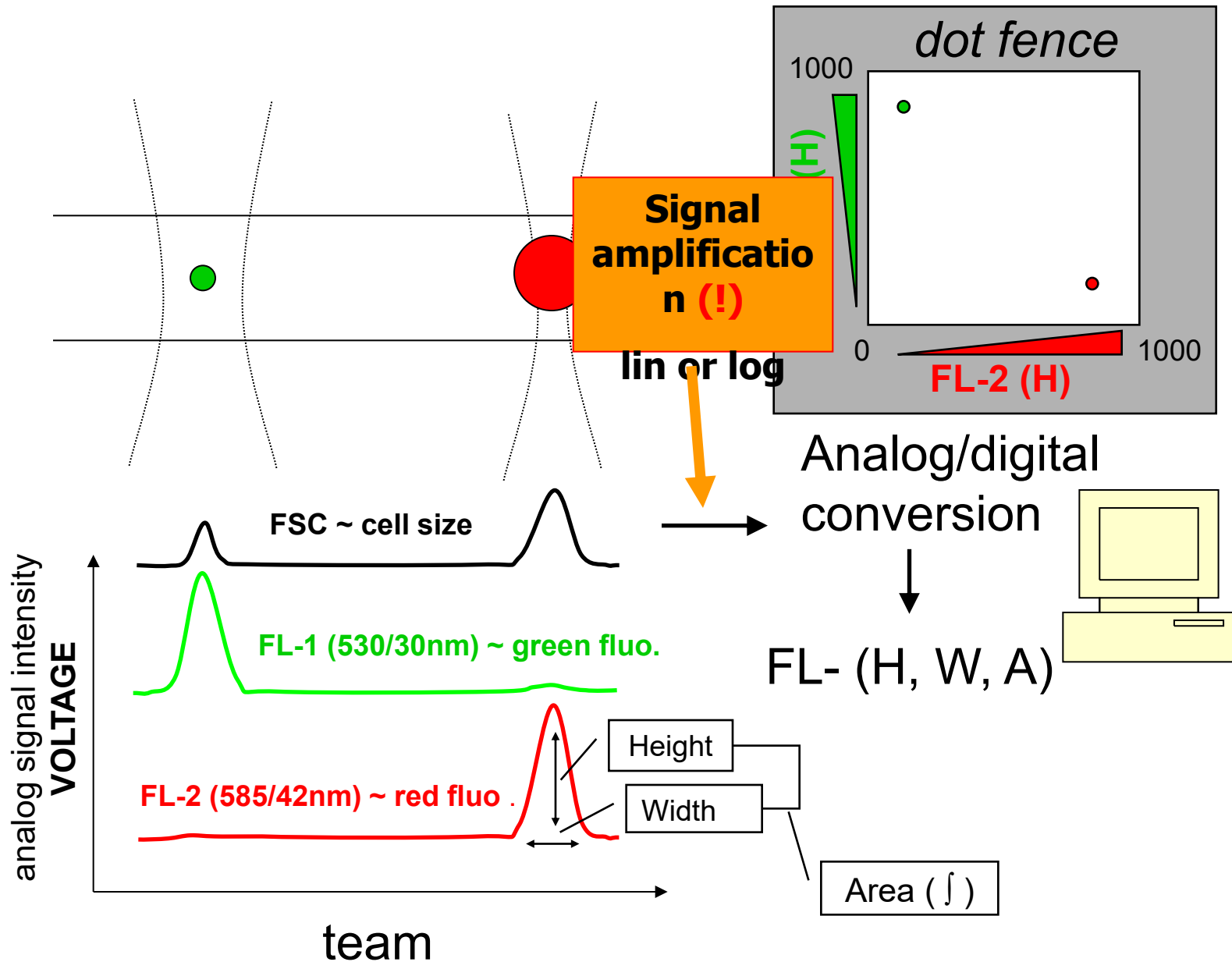

Analog to Digital Converter

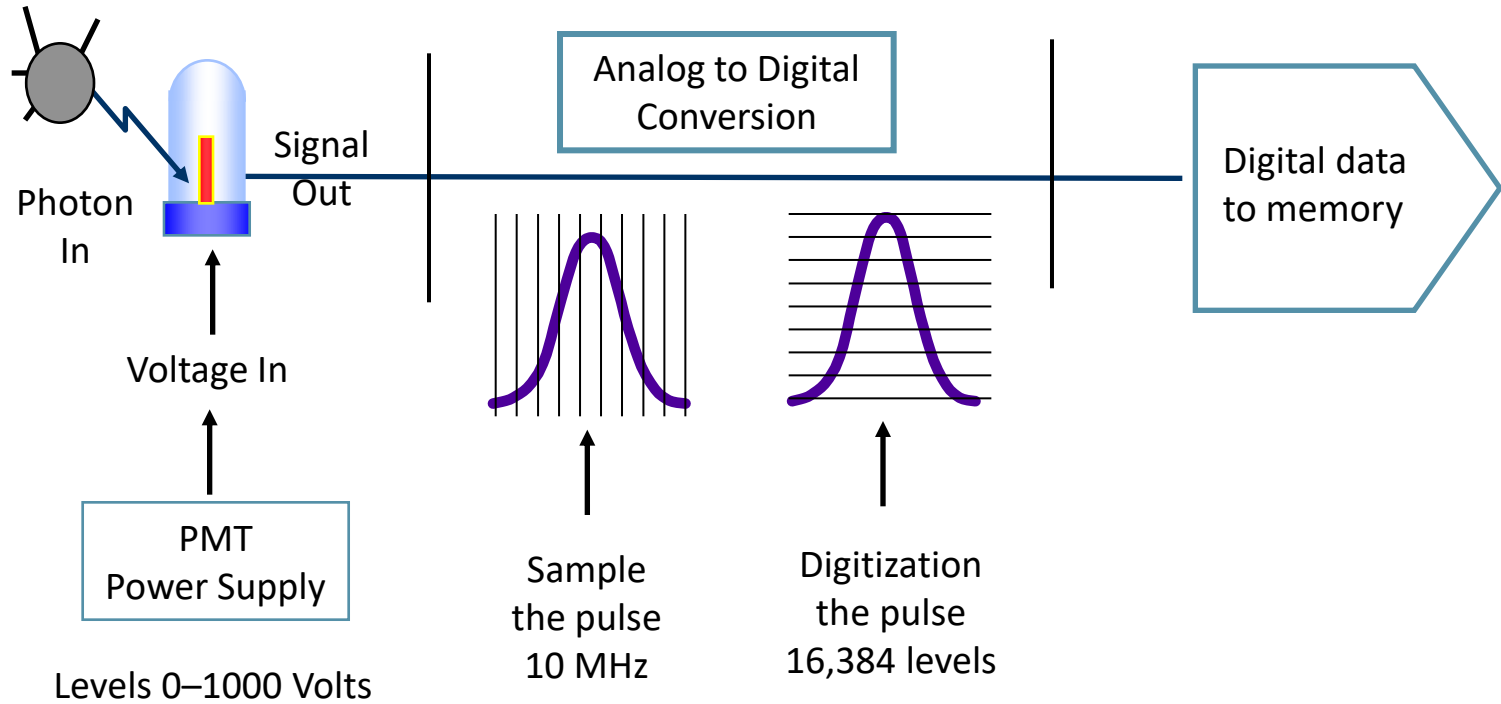

Parameters

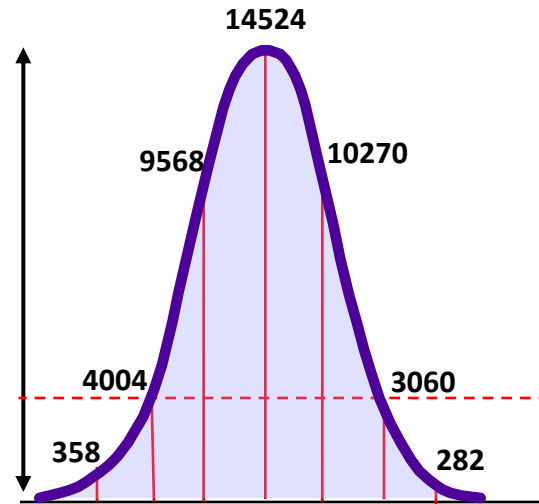

- Area: Sum of all height values
- Height: Maximum digitized value X 16
- Width: Area/Height X 64K

Data is displayed on a 262,144 scale

$$2^8 = 256$$

$$2^{10} = 1024$$

AD converters

Number of bits	# channels	distinction
8	256	39.1 mV
10	1024	9.77 mV
12	4096	2.44 mV
14	16384	610 μ asl
16	65536	153 μ E
18	262144	38.1 μ E
20	1048576	9.54 μ V
22	4194304	2.38 μ H
24	16777216	596 AD

Full scale measurement range = 0 to 10 volts

ADC resolution is 12 bits: $2^{12} = 4096$ quantization levels

ADC voltage resolution is: $(10-0)/4096 = 0.00244$ volts = 2.44 mV

Logarithmic gain & dynamic range

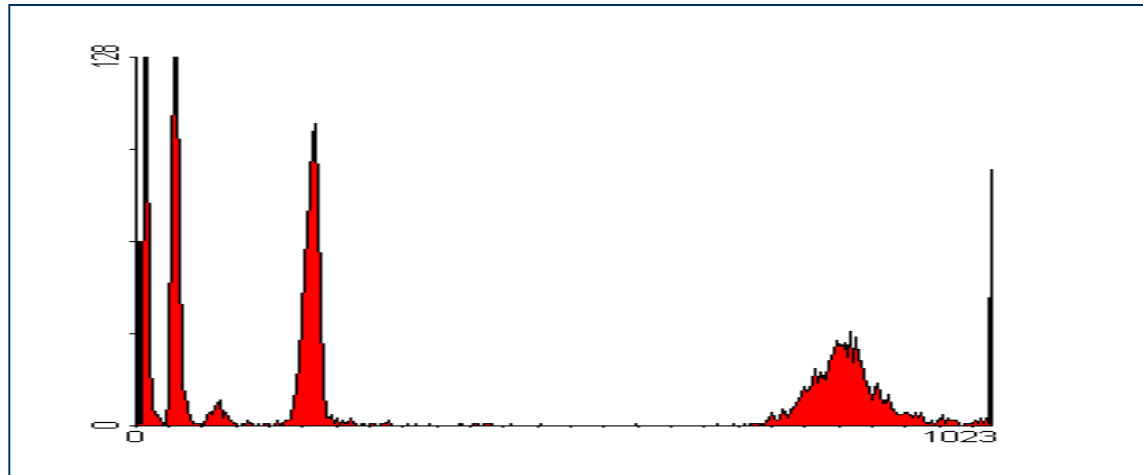

tench

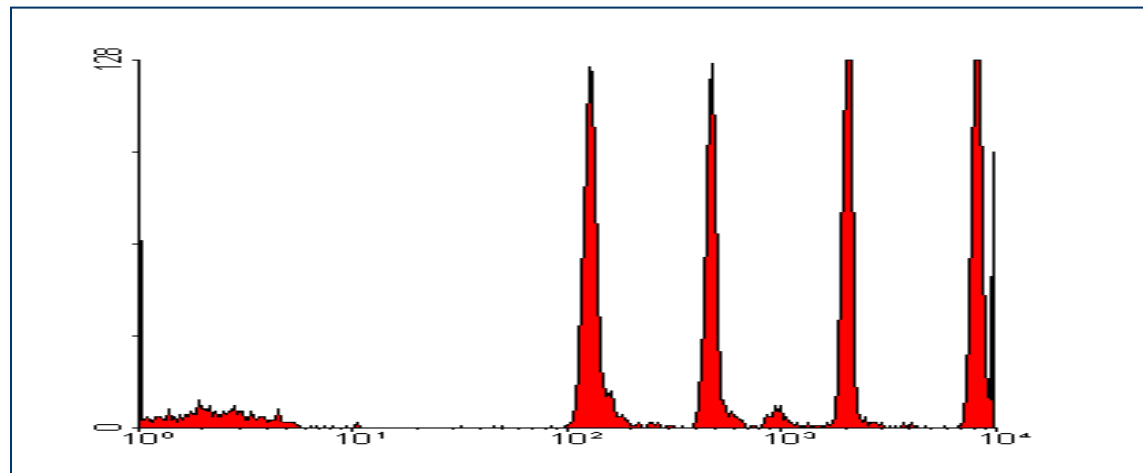

logo



Data analysis

■ View data

- histogram
- dot fence
- isometric display
- contour fence
- chromatic (color) plots
- 3D projection

■ Gating

Ways to display data

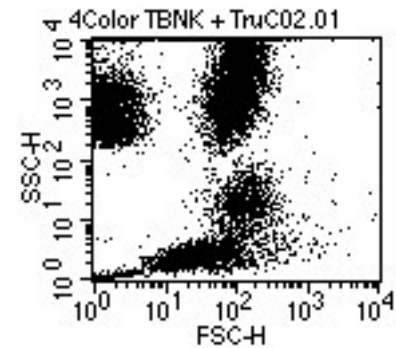
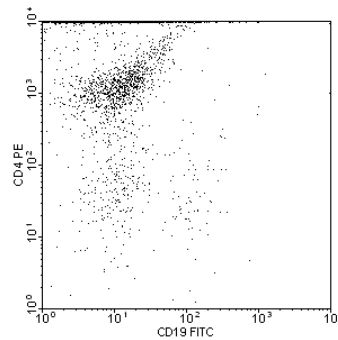
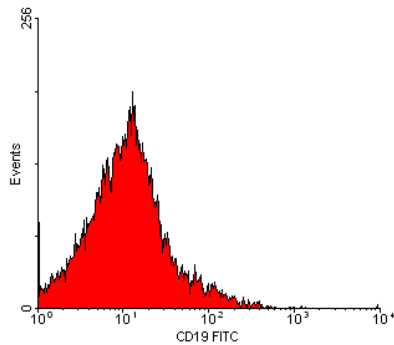

4Color TBNK + TruCO2.01

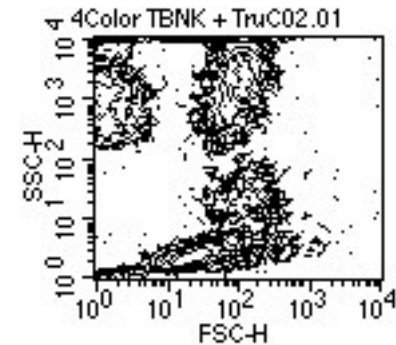
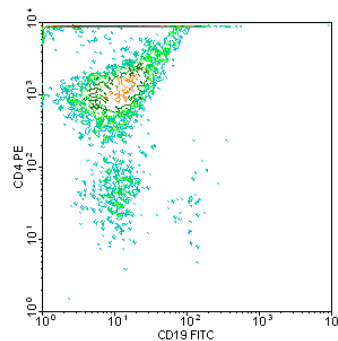
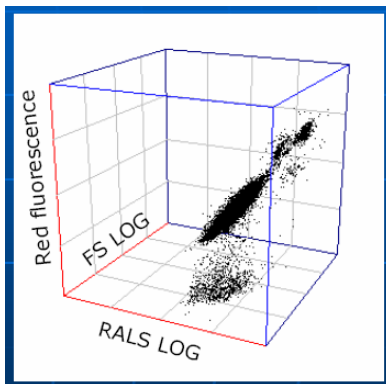
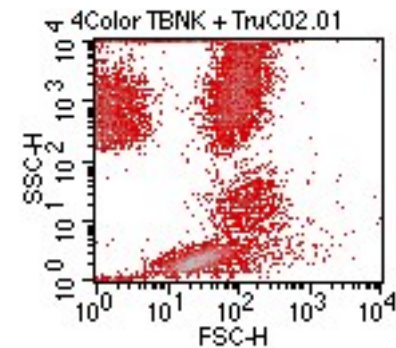
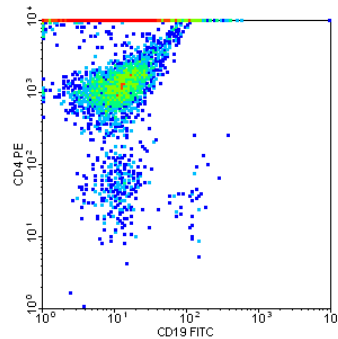

Summary

- Fluid systems
- Sorting
- Signal, data – basic principle

At the end of today's lecture you should :

1. Know the basic principles of light scattering
2. and fluorescence;
3. to know what light sources are used in flow cytometry ;
4. and how it is detected;
5. know the basic principles of fluid systems and laminar flow.
6. Know the basic principle of data processing and visualization